

Interest Earnings

**Capital Land Grant
Coal Trust Interest
Common School Interest & Income
Cultural & Aesthetics Trust Interest
Deaf & Blind Trust Interest
Economic Development Trust Interest
Parks Trust Interest
Pine Hills Trust Interest
Regional Water Trust Interest
Resource Indemnity Trust Interest
Tobacco Settlement Trust Interest
Treasure State Endowment Trust Interest
Treasury Cash Account Interest**

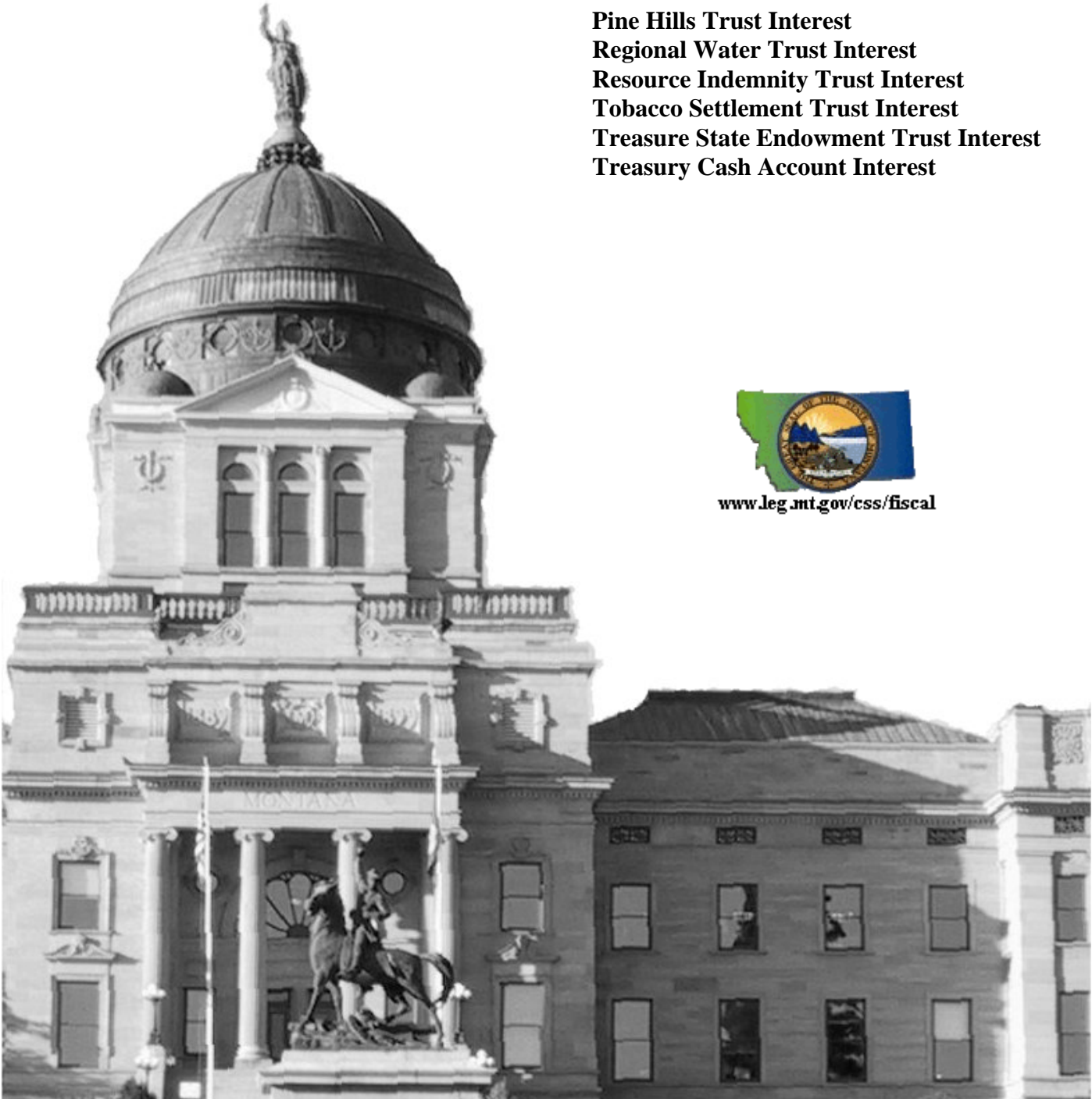

www.leg.mt.gov/css/fiscal

Legislative Fiscal Division

Revenue Estimate Profile

Capital Land Grant Interest and Income

Revenue Description: Lands granted by the federal government to the state generate income from a variety of sources. Section 12 of the *Enabling Act* requires that income generated on certain sections of federally granted land be used for public buildings at the state capital for construction, repair, renovation, and other permanent improvements of state buildings. Capital land grant funds can also be used for the acquisition of land for such buildings, as well as the payment of principal and interest on bonds issued for any of these purposes.

Non-permanent sources of revenue generated from capital land grant lands include: grazing fees, agricultural fees, miscellaneous fees and rentals, and oil and natural gas leases and penalties. Statute requires that 3.0 percent of total non-permanent revenue be diverted to the Department of Natural Resources and Conservation (DNRC) for resource development purposes. Senate Bill 48, passed by the 1999 legislature, allows an amount up to 10 percent of the previous year's revenue to be diverted each year to a state special revenue account used to fund the Trust Land Management Division of DNRC. Permanent sources of revenue generated from capital land grant lands include timber sales and oil and natural gas royalties. A portion of timber sale revenue is diverted to DNRC to fund a portion of its timber program based on the amount appropriated by the legislature (the remaining portion is funded with timber sale revenue from the common school and other land trusts that generate timber revenue).

Statutory Reference:

- Tax Rate – NA
- Tax Distribution (MCA) – 18-2-107
- Enabling Act, Sections 10, 12 & 17
- Other (MCA) – DNRC trust land administration diversion (77-1-109)
 - DNRC timber sale program diversion (77-1-613)
 - DNRC land bank administration diversion (77-2-362)
 - DNRC resource development diversion (77-1-607)

Applicable Tax Rate(s): N/A

Distribution: After diversions for DNRC administration, all remaining capital land grant income is deposited into a capital projects fund to be used for projects on the state capital complex in accordance with the provisions of Section 12 of the *Enabling Act*.

Distribution Chart:

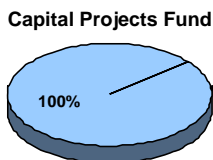

Collection Frequency: Monthly

% of Total General Fund Revenue: N/A

Revenue Estimate Methodology:

The estimate for interest and income from the capital land grant trust is conducted with the goal of deriving the net amount of revenue that will be distributed to the trust beneficiary. This means that in addition to estimating the various revenues from the capital land grant trust, estimates of the various diversions that reduce the amount of revenue deposited to the capital program fund must also be estimated. Therefore, the estimated amounts shown for this revenue source are not total revenues, but are net of diversions. Since all of the trust income is distributed, the trust has no monetary corpus.

Legislative Fiscal Division

Revenue Estimate Profile

Capital Land Grant Interest and Income

Data

Data from SABHRS provide a history of each individual interest and income revenue component from which estimates can be made. Department of Natural Resources and Conservation (DNRC) annual reports provide additional information such as mineral prices and production. Budget submissions on the state budgeting system (MBARS) provide anticipated amount of diversions.

Analysis

The estimate is derived by first estimating the revenue components and then estimating the amounts of the diversions.

Revenue Components

1. Timber – Estimates of timber harvest from capital land grant trust lands are taken directly from DNRC estimates.
2. Grazing Fees – Rates are tied to the price of cattle. Cattle prices are expected to be close to those experienced in FY 2008, perhaps slightly less. DNRC personnel anticipate the grazing fee revenue will be similar to FY 2008.

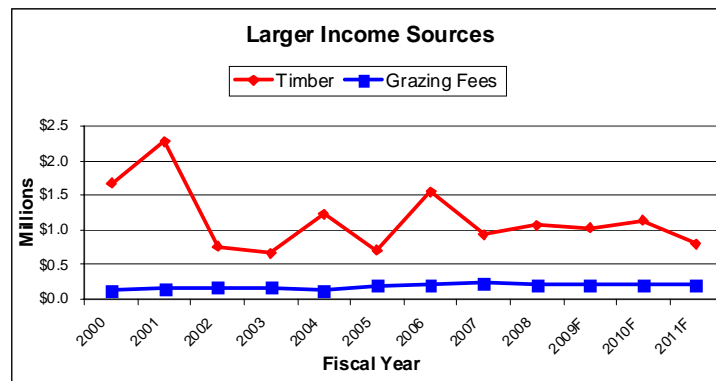

3. Miscellaneous Rentals - These are small income components that are combined and estimated together. For each fiscal year estimated, the estimate is based on the average annual growth rate of the previous four years with the highest and lowest amounts removed.
4. Agricultural Fees - Fees are based on a crop share basis. Commodity prices are expected to be higher than FY 2008 resulting in greater returns. DNRC personnel anticipate that overall revenue will be higher than FY 2008 levels (see the figure below). Based on this information, revenues are increased in FY 2009 and remain constant through FY 2010 and FY 2011.
5. Oil & Gas Bonuses - With record highs in energy prices, competition to obtain mineral leases has increased, resulting in larger bonus payments. Estimates continue the amount received in fiscal 2008.
6. Oil & Gas Leases – For each fiscal year estimated, the estimate is the average of the previous nine years with the highest and lowest years discarded.
7. Mineral Royalties – Mineral royalties are received from oil and natural gas. Oil royalties are estimated by increasing the previous fiscal year's production by the growth rate obtained from average annual growth from for the previous 13 years with the highest and lowest years discarded. For natural gas royalties, estimates continue at the amount received in fiscal 2008.
8. Oil & Gas Penalties – For each fiscal year estimated, the estimate is the average of the previous two years.

Legislative Fiscal Division

Revenue Estimate Profile

Capital Land Grant Interest and Income

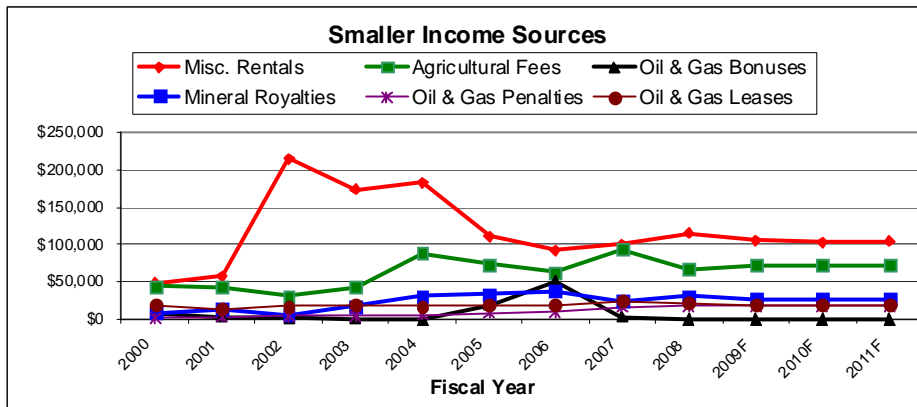

Diversions

Diversions fund operational costs in DNRC, but reduce the amount of revenue distributed to the trust beneficiaries (see the figure below). To determine future diversion amounts, DNRC's present law budget amounts are used.

1. Trust Land Administration Account – Of the total expenditures requested to be made from this account, a portion is funded by capital land grant trust revenue. That portion is determined by multiplying current year revenue estimates by the ratio of FY 2008 costs to FY 2007 revenue. In fiscal 2008, the capital land grant trust funded 2.0 percent of total expenditures.
2. Timber Sales Account – A portion of timber sale revenue from the capital land grant trust is used to fund costs associated with the timber sale program on the trust lands. Other trusts with timber revenue also pay into this account. The portion each pays is the ratio of its timber sale revenue to the total state-wide timber sale revenue multiplied by the total cost of the program. This diversion reduced permanent revenue that would have been deposited to the trust.
3. Resource Development Account – Three percent of all income from the trust is diverted to an account to fund resource development on the trust lands. Mineral royalties are excluded.

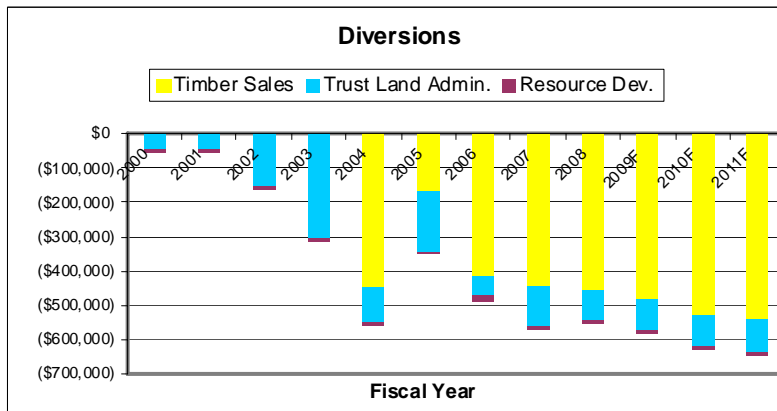

Adjustments and Distribution

Once total revenue and total diversions have been estimated, the net amounts are distributed 100 percent to the capital project fund.

Legislative Fiscal Division

Revenue Estimate Profile

Capital Land Grant Interest and Income

Forecast Methodology:

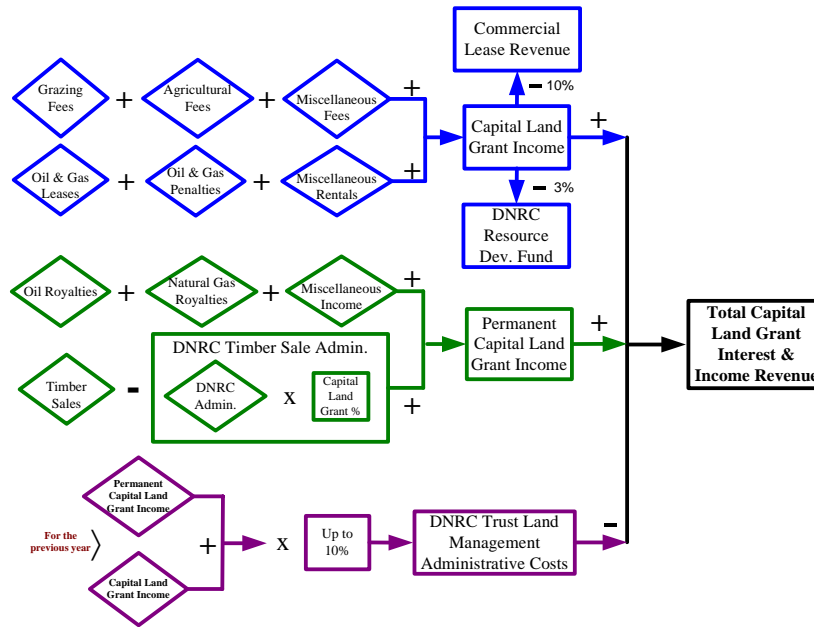

Revenue Estimate Assumptions:

	t	Total Rev.	GF Rev.	TFBP	STIP	Capital
	Fiscal	Millions	Millions	Interest	Interest	Land Share
				Millions	Millions	T&L
Actual	2000	1.920809	0.000000			0.000000
Actual	2001	2.527118	0.000000			0.000000
Actual	2002	1.065036	0.000000	29.627056	0.102664	0.000000
Actual	2003	0.808807	0.000000	29.146744	0.068370	0.000000
Actual	2004	1.976678	0.000000	30.087011	0.053502	0.000000
Actual	2005	0.853171	0.000000	28.106281	0.269698	0.000000
Actual	2006	1.589963	0.000000	24.428206	0.408162	0.000000
Actual	2007	0.870700	0.000000	26.206838	0.267652	0.000000
Actual	2008	0.982735	0.000000	25.159580	0.128925	0.000000
Forecast	2009	0.898000	0.000000	24.474900	0.076364	0.000000
Forecast	2010	0.966000	0.000000	24.552355	0.250056	0.000000
Forecast	2011	0.617000	0.000000	25.005341	0.696125	0.000000

	t	Trust Income	Trust Land	New Deposit	Non Pool	Non Pool
	Fiscal	New Deposit	Admin.	Long Term	STIP	STIP Bal
		Millions	Millions	Rate	Rate	Millions
Actual	2000	10.969295		7.0160%	5.4290%	11.676486
Actual	2001	12.667780	-0.048140	6.8850%	4.7390%	6.984553
Actual	2002	2.348339	-0.151480	6.3380%	2.5650%	7.334239
Actual	2003	2.363355	-0.305417	5.7290%	1.3600%	6.242273
Actual	2004	2.971526	-0.098964	5.3650%	1.2650%	7.049634
Actual	2005	1.457756	-0.172683	5.1940%	2.3870%	12.106697
Actual	2006	1.425106	-0.062659	5.2340%	4.0770%	3.862666
Actual	2007	7.173844	-0.114745	5.4050%	4.7290%	14.953757
Actual	2008	3.101654	-0.085035	5.3790%	3.1940%	2.461097
Forecast	2009	1.410837	-0.090509	5.4900%	1.4970%	2.461097
Forecast	2010	8.269190	-0.087293	5.4780%	1.6830%	2.461097
Forecast	2011	22.455124	-0.093992	5.7480%	3.2000%	2.461097

Legislative Fiscal Division

Revenue Estimate Profile

Capital Land Grant Interest and Income

	<u>t</u>	<u>Grazing</u>	<u>Agriculture</u>	<u>Misc.</u>	<u>O&G Lease</u>	<u>O&G Bonus</u>	<u>O&G Penalty</u>	<u>Misc.</u>
	<u>Fiscal</u>	<u>Millions</u>	<u>Millions</u>	<u>Millions</u>	<u>Millions</u>	<u>Millions</u>	<u>Millions</u>	<u>Millions</u>
Actual	2000	0.132580	0.044452	0.000000	0.019153	0.009104	0.002343	0.048046
Actual	2001	0.159924	0.043153	0.000000	0.013722	0.002980	0.003287	0.057476
Actual	2002	0.173945	0.030825	0.000000	0.018286	0.002180	0.004428	0.215148
Actual	2003	0.170050	0.043195	0.000000	0.018497	0.001020	0.004170	0.173664
Actual	2004	0.132298	0.088177	0.000000	0.017818	0.000000	0.005399	0.183365
Actual	2005	0.197466	0.073605	0.000000	0.019107	0.018820	0.008633	0.110300
Actual	2006	0.210403	0.063134	0.000000	0.019001	0.050616	0.010166	0.091908
Actual	2007	0.238825	0.093304	0.000000	0.024241	0.003840	0.016487	0.100922
Actual	2008	0.206167	0.067380	0.000000	0.021340	0.000040	0.018223	0.114930
Forecast	2009	0.206167	0.072866	0.000000	0.019029	0.000040	0.017355	0.105611
Forecast	2010	0.206167	0.072866	0.000000	0.019011	0.000040	0.017789	0.103267
Forecast	2011	0.206167	0.072866	0.000000	0.019182	0.000040	0.017572	0.104439

	<u>t</u>	<u>Int. Land</u>	<u>Int. STIP</u>	<u>Int. Trust</u>	<u>Res. Dev.</u>	<u>Lease Total</u>	<u>Timber Cost</u>
	<u>Fiscal</u>	<u>Millions</u>	<u>Millions</u>	<u>Millions</u>	<u>Millions</u>	<u>Millions</u>	<u>Millions</u>
Actual	2000	0.000000	0.000000	0.000000	-0.007670	0.248008	
Actual	2001	0.000000	0.000000	0.000000	-0.008268	0.272274	
Actual	2002	0.000000	0.000000	0.000000	-0.008838	0.435974	
Actual	2003	0.000000	0.000000	0.000000	-0.009311	0.401285	0.000000
Actual	2004	0.000000	0.000000	0.000000	-0.012622	0.414435	-0.448435
Actual	2005	0.000000	0.000000	0.000000	-0.009255	0.418676	-0.168515
Actual	2006	0.000000	0.000000	0.000000	-0.012793	0.432435	-0.412498
Actual	2007	0.000000	0.000000	0.000000	-0.013814	0.463805	-0.445082
Actual	2008	0.000000	0.000000	0.000000	-0.012794	0.415286	-0.456737
Forecast	2009	0.000000	0.000000	0.000000	-0.012632	0.408436	-0.481355
Forecast	2010	0.000000	0.000000	0.000000	-0.012574	0.406566	-0.530623
Forecast	2011	0.000000	0.000000	0.000000	-0.012608	0.407658	-0.540021

	<u>t</u>	<u>Oil Roy.</u>	<u>Gas Roy.</u>	<u>Timber</u>	<u>Misc.</u>	<u>Perm. Total</u>
	<u>Fiscal</u>	<u>Millions</u>	<u>Millions</u>	<u>Millions</u>	<u>Millions</u>	<u>Millions</u>
Actual	2000	0.004394	0.004489	1.675671	0.028247	1.712801
Actual	2001	0.005659	0.008068	2.278363	0.010894	2.302984
Actual	2002	0.003264	0.002190	0.769197	0.005891	0.780542
Actual	2003	0.004461	0.013330	0.671819	0.023329	0.712939
Actual	2004	0.003492	0.027817	1.231369	0.846964	1.661207
Actual	2005	0.005271	0.027867	0.712329	0.030226	0.607178
Actual	2006	0.005020	0.033062	1.558251	0.036352	1.220187
Actual	2007	0.006658	0.018361	0.933816	0.007887	0.521640
Actual	2008	0.008281	0.023358	1.072080	0.005502	0.652484
Forecast	2009	0.004046	0.023358	1.027525	0.006695	0.580269
Forecast	2010	0.004195	0.023358	1.143669	0.006099	0.646698
Forecast	2011	0.004359	0.023358	0.808925	0.006397	0.303018

Total Rev. = Grazing + Agriculture + O&G Lease + O&G Bonus + O&G Penalty + Misc. +
 Int. Land + Int. Stip + Int. Trust + Timber + Res. Dev. + Oil Roy. + Gas Roy. + Timber + Misc. +
 Timber Cost + Trust Land Admin.

Legislative Fiscal Division

Revenue Estimate Profile

Capital Land Grant Interest and Income

Revenue Projection:

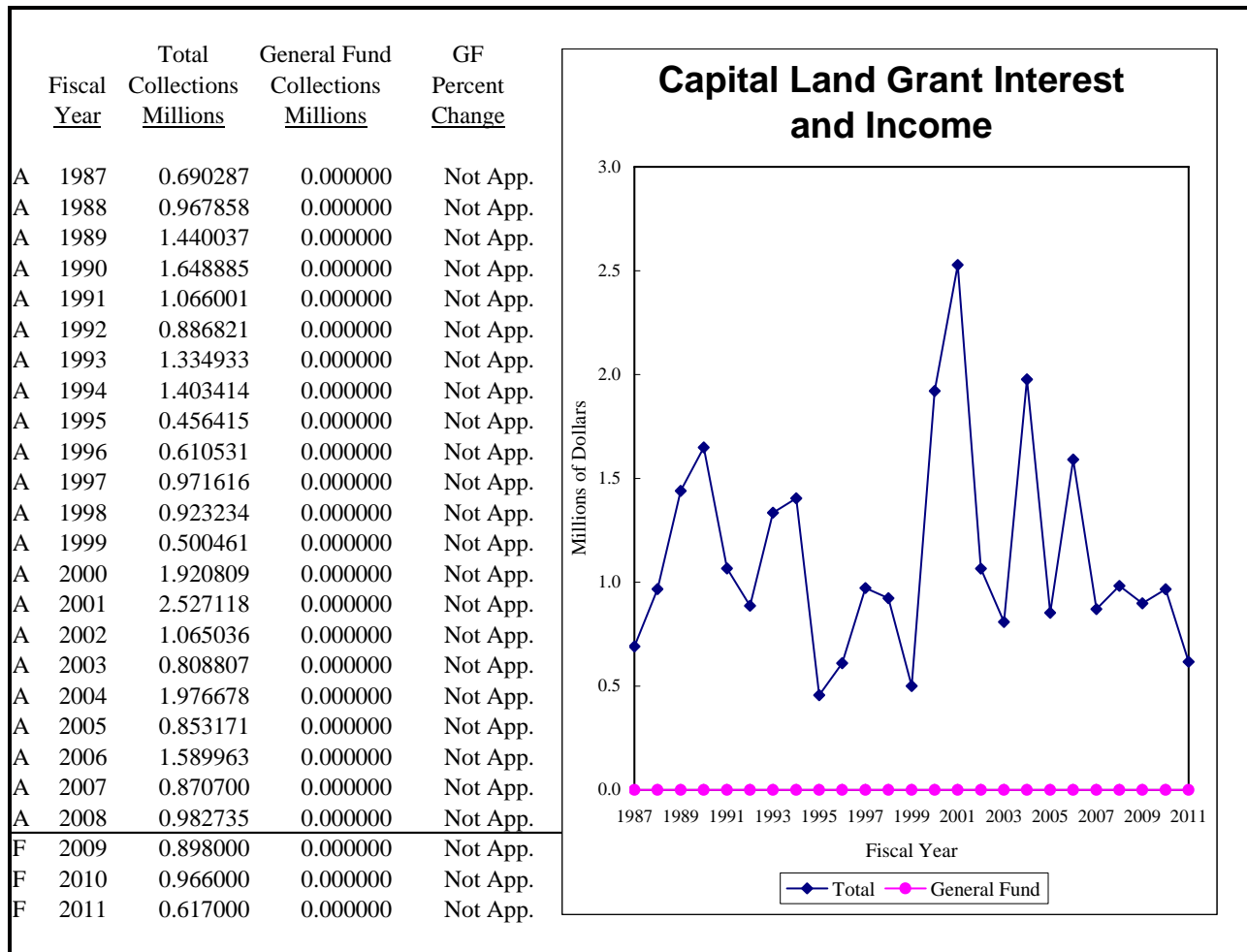

Data Source(s): SABHRS, Wall Street Journal, Department of Natural Resources and Conservation

Contacts: Department of Administration, Department of Natural Resources and Conservation

Legislative Fiscal Division

Revenue Estimate Profile

Coal Trust Interest

Revenue Description: Article IX, Section 5 of the Montana Constitution requires that 50.0 percent of all coal severance tax revenue be deposited in a permanent coal trust fund and that the principal of the trust "shall forever remain inviolate unless appropriated by a three-fourths vote of each house". Coal severance tax funds flowing into the trust fund are first used to secure and subsidize state bonds issued to finance water resource and renewable resource development projects and activities. With the enactment of House Bill 249 by the 2005 legislature, beginning fiscal 2006 the remaining funds are then split 50 percent (25 percent of total revenue) to the treasure state endowment trust fund, 25 percent (12.5 percent of total revenue) to the treasure state endowment regional water system trust fund, and 25 percent (12.5 percent of total revenue) to the big sky economic development trust fund. The permanent trust fund no longer receives coal severance tax revenue. By statute, interest earned on the permanent trust that is not earmarked to other programs is deposited to the general fund. When calculating interest earnings, the impact of loans made from the trust, such as the in-state investment program, is taken into account.

As of October 1, 1995, all fixed-income investments held by the state's major trust funds were transferred to a newly-created trust fund bond pool (TFBP). The majority of permanent coal tax trust funds are invested as part of the TFBP. Some funds, however, are invested on a short-term basis in the state's short-term investment pool (STIP). In addition, state law provides that trust funds may be used for in-state commercial loans to stimulate economic development. The state Constitution prohibits the investment of the permanent trust in common stock.

Statutory Reference:

Tax Rate - NA

Distribution (MCA) - Montana Constitution, Article IX, Section 5; 17-5-704; 15-35-108

Date Due - NA

Applicable Tax Rate(s): N/A

Distribution: Interest earned on the permanent coal tax trust fund is deposited into the general fund. Statute further annually statutorily appropriates interest income from \$140 million of the coal severance tax permanent fund as follows:

Fiscal 2006 - 2010

\$3,650,000 – to the research and commercialization state special revenue account

\$1,250,000 – for the growth through agriculture program

\$425,000 – to the Department of Commerce for certified regional development corporations

\$300,000 – to the Department of Commerce for export trade enhancement

\$200,000 – to the Department of Commerce for the Montana manufacturing extension center at MSU-Bozeman

\$125,000 – to the Department of Commerce for a small business development center

\$65,000 – to the Cooperative Development Center

\$50,000 – to the Department of Commerce for a small business innovative research program

\$6,065,000

Legislative Fiscal Division

Revenue Estimate Profile

Coal Trust Interest

Distribution Chart:

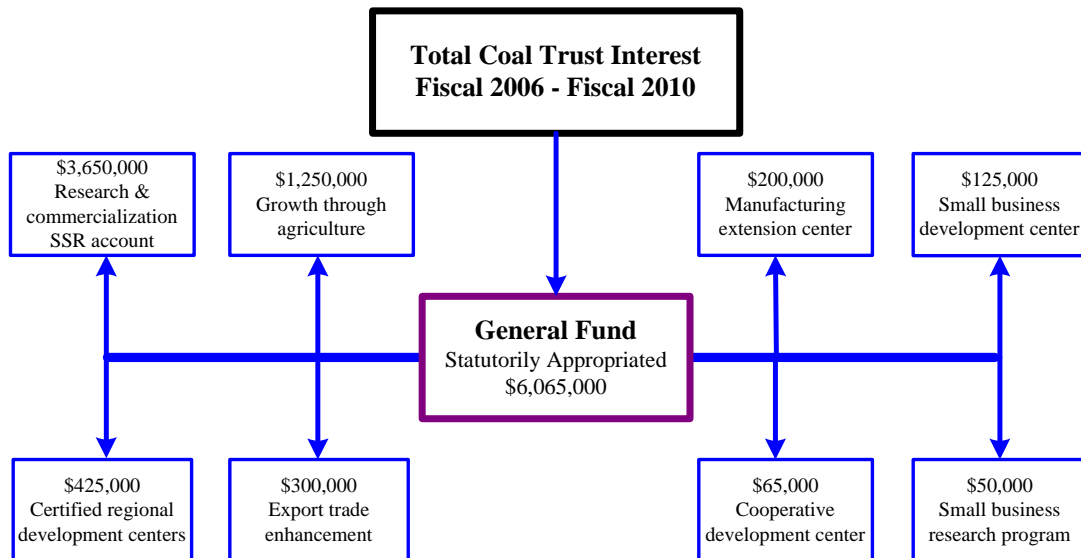

Collection Frequency: Monthly

% of Total General Fund Revenue:

FY 2004 – 2.53%	FY 2007 – 1.76%
FY 2005 – 2.40%	FY 2008 – 1.47%
FY 2006 – 1.82%	

Revenue Estimate Methodology:

Data

The data used to estimate interest earnings from the coal trust are obtained from the Board of Investments (BOI), Global Insight, and the state accounting system (SABHRS). The BOI provides information on historic interest rates as well as the gains and losses from the sale of securities. Projections of future interest rates are provided by Global Insight and historic interest collections are obtained from SABHRS.

Analysis

The coal trust was created from distributions of the coal severance tax. While the Constitution requires that 50 percent of the coal severance tax collections be distributed into the coal trust, in early the 1990's the first sub-trust was created and two more were subsequently formed. Currently, the required coal tax revenue flows into the three sub-trusts and none of the tax revenue is deposited into the permanent coal trust. The principal or corpus of the coal trust (the portion that generates general fund interest) now stands at \$531.7 million.

To forecast the coal trust interest earnings, four interest/income components are estimated independently and summed. The interest/income components include:

- Trust funds bond pool (TFBP)
- In-state investments
- Short-term investment pool (STIP)
- Payback interest

The TFBP was formed in 1995 to manage the fixed investments held in the state's major trust funds. Each trust owns "shares" of the pool and interest earnings are paid to each trust on a per-share basis. TFBP earnings are the largest source of earnings for the trust, as shown in the figure below. To estimate TFBP earnings, the base year (fiscal 2008) rate of return generated by the pool, as reported by the BOI, is adjusted during the forecast period for maturing securities. The applicable new long-term rate

Legislative Fiscal Division

Revenue Estimate Profile

Coal Trust Interest

for these securities is based on an average of four long-term rates projected by Global Insight. The fiscal year long-term rate is expected to be 5.5 percent in fiscal years 2009 and 2010 and 5.7 percent for fiscal year 2011.

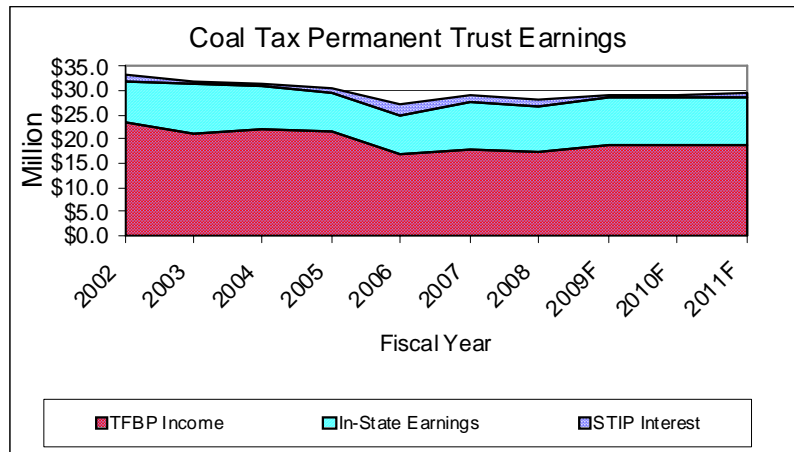

As seen in the figure above, earnings from in-state investments are the second largest source of income to the coal tax trust. The BOI is required by statute to invest twenty-five percent of the coal tax trust in the Montana economy. Investments must be made to maximize the long-term benefit to the Montana economy. In-state investments primarily consist of loans to Montana business entities and earnings are equal to the interest charged on the loans. The in-state balance is held constant throughout the biennium because no new flow of revenue is expected.

STIP interest (including other interest) is earned on cash, prior to investment in long-term investments. Funds are acquired from new deposits and/or maturing securities in the forecast period. Funds are held in STIP until the BOI determines that conditions are favorable for investment in the TFBP. To estimate future STIP earnings, an average short-term interest rate is developed based on Global Insight projections of three short-term investments. The average of these rates is then converted to a fiscal year basis. The average fiscal year short-term rate is expected to be 1.5 percent in fiscal 2009, 1.7 percent in fiscal 2010, and 3.2 percent in fiscal 2011.

Payback interest earnings result from a loan of \$46.4 million to the common school trust fund, approved in SB 495 during the 2003 session. Interest on the loan is required to equal the rate of return generated by the TFBP. Additional income is derived from payment of the loan principal. Principal repayments may be temporarily placed into STIP and earn interest until invested in the TFBP. Loan interest paid into the trust declines as the outstanding principal is repaid. Earnings on loan principal payments are projected by applying the TFBP long-term interest rate to the principal payments.

After the estimates are calculated, the projected earnings from the four sources are combined to reach total coal trust interest revenue, and the revenues are distributed as described above.

Legislative Fiscal Division

Revenue Estimate Profile

Coal Trust Interest

Forecast Methodology:

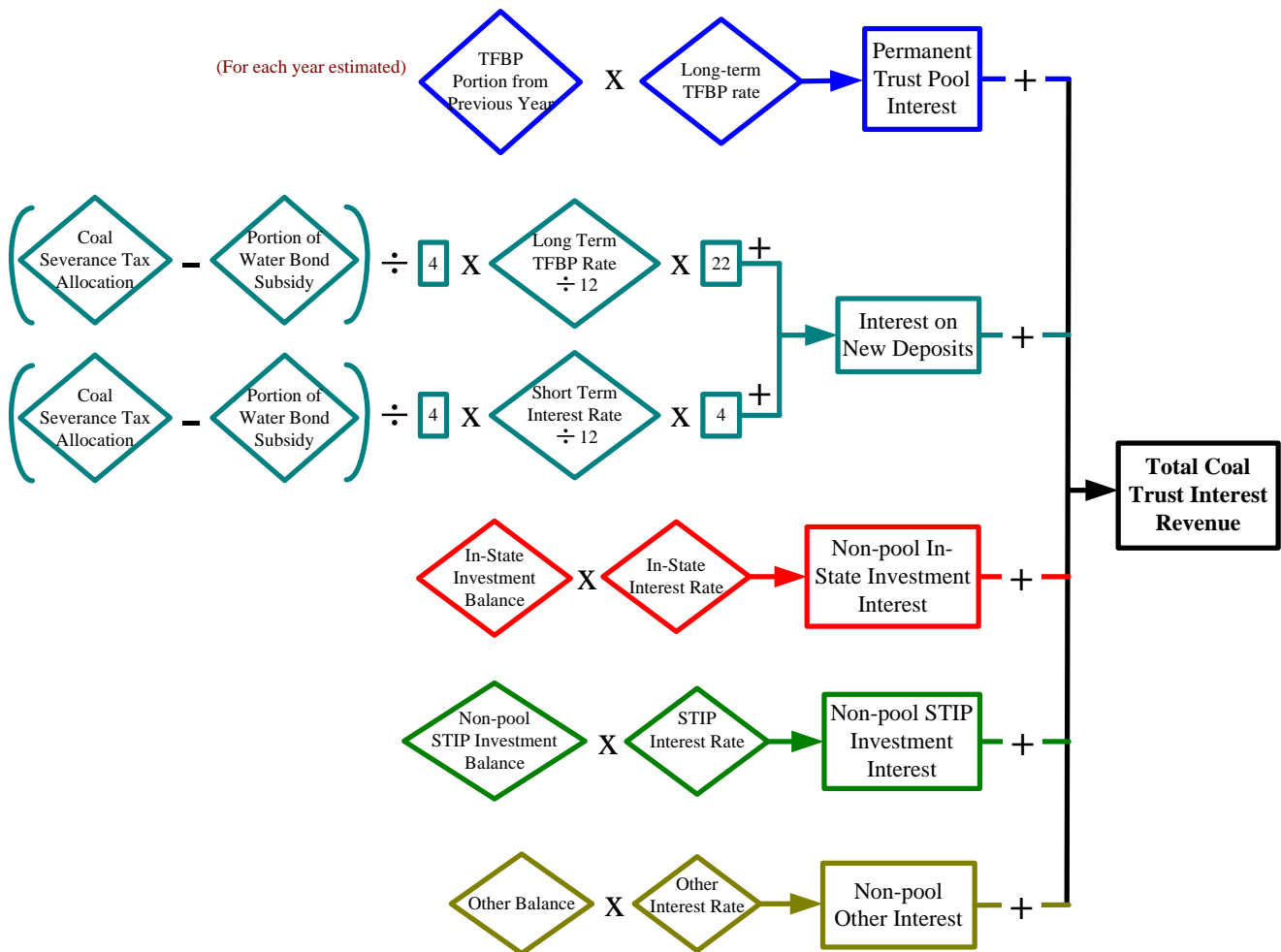

Legislative Fiscal Division

Revenue Estimate Profile

Coal Trust Interest

Revenue Estimate Assumptions:

t	Total Rev.	GF Rev.	TFBP	In_State	Other	STIP	Payback
Fiscal	Millions	Millions	Interest	Interest	Interest	Interest	Interest
			Millions	Millions	Millions	Millions	Millions
Actual	2000	39.195203	39.195203				
Actual	2001	37.659527	37.659527				
Actual	2002	37.605247	37.605247	23.317933	8.764717	0.401582	1.096936
Actual	2003	36.297863	36.297863	21.079491	10.501432	0.027838	0.388276
Actual	2004	34.907273	34.907273	22.273639	8.721596	0.055237	0.451386
Actual	2005	36.751940	36.751940	21.418762	8.231060	2.309776	0.691339
Actual	2006	31.106170	31.106170	16.717821	8.337924	0.345783	2.116771
Actual	2007	32.334879	32.334879	17.616328	10.084960	1.219784	1.377621
Actual	2008	28.854611	28.854611	17.570357	9.346191	0.154346	1.500741
Forecast	2009	29.392000	29.392000	18.975011	9.753138	0.682306	0.273666
Forecast	2010	28.787000	28.787000	18.975011	9.753138	0.322035	0.321398
Forecast	2011	28.606000	28.606000	18.975011	9.753138	0.126993	0.636432

t	Net Coal Tax	Bond	New Deposit	Non Pool	Non Pool	Non Pool	Gains
Fiscal	New Deposit	Subsidy	Long Term	STIP	In State	Loan	Millions
	Millions	Millions	Rate	Rate	Rate	Rate	
Actual	2000	0.000000	0.193782	6.3380%	5.4290%	0.0000%	0.0000%
Actual	2001	0.000000	0.480790	6.8850%	4.7390%	0.0000%	0.0000%
Actual	2002	0.000000	0.264847	6.3380%	2.5650%	5.5888%	7.2673%
Actual	2003	0.000000	0.780492	5.7290%	1.3600%	6.2141%	7.0000%
Actual	2004	3.943085	1.473545	5.3650%	1.2650%	5.3526%	7.3445%
Actual	2005	4.704314	1.294028	5.1940%	2.3870%	5.3648%	7.3445%
Actual	2006	0.000000	0.417249	5.2340%	4.0770%	5.3524%	7.3445%
Actual	2007	0.000000	0.000000	5.4050%	4.7290%	5.6001%	6.1505%
Actual	2008	0.000000	0.000000	5.3790%	3.1940%	5.3500%	5.7249%
Forecast	2009	0.000000	0.802513	5.4900%	1.4970%	5.3500%	5.5732%
Forecast	2010	0.000000	0.084771	5.4780%	1.6830%	5.3500%	5.5732%
Forecast	2011	0.000000	0.277757	5.7480%	3.2000%	5.3500%	5.5732%

t	Non Pool	Non Pool	Non Pool	SB495 Loan	Invested	Average	SB69
Fiscal	STIP Bal	In-State Bal	Loan Bal	Payment	Balance	Return	Impacts
	Millions	Millions	Millions	Millions	Millions	Rate	Millions
Actual	2000	15.334577	127.567412	0.000000			
Actual	2001	22.784722	145.401756	0.000000			
Actual	2002	26.721811	168.249355	46.366904			
Actual	2003	37.107451	169.737929	46.366904			
Actual	2004	41.478106	156.145542	46.366904			
Actual	2005	48.813893	150.708090	44.546088	1.820816	552.184053	0.066125
Actual	2006	50.509520	160.849807	41.896025	2.650063	541.169612	0.057480
Actual	2007	33.158539	199.324095	31.047064	10.848961	548.455440	0.058956
Actual	2008	15.910804	182.301654	11.573605	19.473459	538.681324	0.053565
Forecast	2009	15.910804	182.301654	0.000000	11.573605	538.681324	0.054563
Forecast	2010	15.910804	182.301654	0.000000	0.000000	538.681324	0.053441
Forecast	2011	15.910804	182.301654	0.000000	0.000000	538.681324	0.053105

Total Rev. = Invested Balance * Average Return
 GF Rev. = Total Rev.

Legislative Fiscal Division

Revenue Estimate Profile

Coal Trust Interest

Revenue Projection:

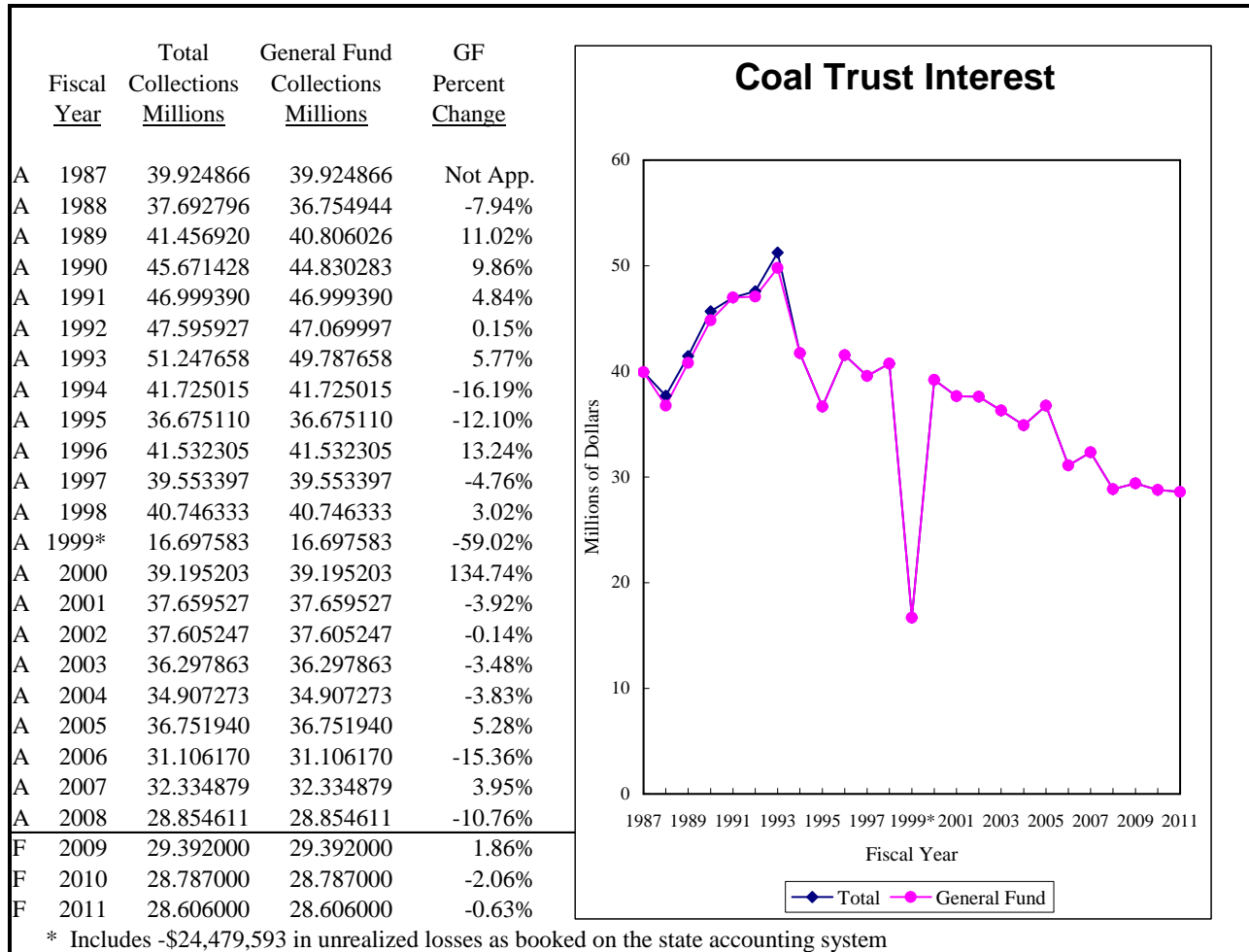

Data Source(s): Board of Investments, SABHRS, *Wall Street Journal*, Global Insight

Contacts: Board of Investments

Legislative Fiscal Division

Revenue Estimate Profile

Common School Interest and Income

Revenue Description: Lands granted by the federal government to the state for the benefit of public schools generate income. The common school trust is actually part of the trust and legacy trust fund that includes nine other trusts. Prior to fiscal 1996, interest and income from the common school trust was deposited in the state equalization account. Beginning in fiscal 1996, this interest and income was deposited in the general fund, as mandated by SB 83, passed by the 1995 legislature. Beginning fiscal 2003, House Bill 7 from the August 2002 special legislative session changed the deposit to the state special revenue guarantee account and statutorily appropriated the money for schools. The estimates show the amount of revenue deposited to the guarantee account and are net of amounts diverted (of mineral royalties, timber sale revenue, and income) for DNRC administration costs. Included is timber revenue for school technology. Mineral royalty revenue required to pay interest and principal on the SB 495 loan is not include since the loan was repaid in FY 2008. All net mineral royalty revenue is deposited to the guarantee account for transfer to the school facility improvement account. These items are explained below.

Common school lands produce two kinds of revenue: 1) distributable income such as interest earnings, agricultural rents or crop shares, and timber sale revenue; and 2) permanent income that is returned to the trust such as income from the sale of minerals (see the effects of Senate Bill 495 from the 2003 legislative session below), land, and easements. Excluding the amount of timber sale revenue diverted for DNRC administration and school technology and after a 3.0 percent deduction of the revenue for use by the Department of Natural Resources and Conservation (DNRC), 95 percent of distributable revenue is available to fund schools and, due to Senate Bill 48 (discussed below), the remaining 5.0 percent is available to fund the Trust Land Management Division of DNRC. The 3.0 percent allocation to DNRC is used for resource development purposes. Timber revenue is allocated: 1) first to DNRC to fund a portion of its timber program based on the amount appropriated by the legislature (the remaining portion is funded with timber sale revenue from the capital land grant and other land trusts that generate timber revenue); 2) the amount received from production over 18 million board feet is deposited into the state special revenue fund for school technology equipment and training and is statutorily appropriated to OPI (House Bill 41 enacted by the 2001 legislature and House Bill 7 from the August 2002 special legislative session); and 3) any remainder for the support of public schools.

Senate Bill 48, passed by the 1999 legislature, provides for the diversion of the following funds for the purpose of funding the Trust Land Management Division in the DNRC: 1) mineral royalties; 2) revenues from the sale of easements; and 3) 5.0 percent of interest and income previously credited to the common school trust. The amount of the money diverted from the common school trust reduces the growth of the trust fund balance and, hence, reduces the amount of distributable interest earnings.

As of October 1, 1995, all fixed-income investments held by the state's major trust funds (which include the trust and legacy fund of which the common school trust is a part), were transferred to a newly-created Trust Funds Bond Pool (TFBP). The majority of common school trust funds are invested as part of the TFBP. Some funds, however, are invested on a short-term basis in the state's Short Term Investment Pool (STIP). The state Constitution prohibits the investment of common school trust funds in common stock. Interest income is distributed 95 percent to the guarantee account and 5 percent is available for DNRC administration with the remainder deposited to the trust.

Senate Bill 495 (enacted by the 2001 legislature) authorized DNRC to purchase the mineral production rights (with a loan from the coal severance trust) from the common school trust. The department subsequently purchased \$138.9 million of net future mineral royalties from the school trust for \$46.4 million. Since these royalties will no longer be deposited to the trust, interest earnings from the trust corpus are lessened. It is estimated that the trust balance will be at least \$92.5 million less after all the \$138.9 million has been distributed. The net mineral royalties are first used to pay the principal and interest of the \$46.4 million loan with the remainder deposited to the guarantee account to fund base aid. Since the loan was paid off in FY 2008, SB 2 (May 2007 special session) directs that all net mineral royalties (until the total amount of \$138.9 million that was purchased is received) are to be deposited to the guarantee account and then transferred to the school facility improvement account. Based on mineral royalty estimates for the 2011 biennium, it is anticipated that the \$138.9 million in net mineral royalties will be achieved in the FY 2010. When this occurs, mineral royalties will again become part of the trust corpus and will generate additional earnings. For further information and analysis on Senate Bill 495 contact the Legislative Fiscal Division for a copy of the two-part report: "Senate Bill 495-Implementation, Impacts and Implications".

Statutory Reference:

Tax Rate – NA

Distribution (MCA) – Montana Constitution Article X, Section 5; 20-9-342 (school technology); 20-9-622 (guarantee account)

Legislative Fiscal Division

Revenue Estimate Profile

Common School Interest and Income

Enabling Act, Section 10

Other (MCA) – DNRC trust land administration diversion (77-1-109)

 DNRC timber sale program diversion (77-1-613)

 DNRC land bank administration diversion (77-2-362)

 DNRC resource development diversion (77-1-607)

 DNRC commercial leasing diversion (77-1-905)

Date Due - the last business day of February following the calendar year in which the money was received (20-9-342).

Applicable Tax Rate(s): N/A

Distribution: As described above, interest and income from common school lands (including a portion of timber sales and after amounts diverted for DNRC administration) are distributed 95.0 percent to the state special revenue guarantee account and are statutorily appropriated for schools. The remaining 5.0 percent is available to fund the Trust Land Management Division with the remainder deposited to the trust fund. Up until the total of \$138.9 million of purchased royalties is reached, the portion of mineral royalties not used for DNRC administration is deposited to the guarantee account and, with the enactment of SB 2 (May 2007 special session), transferred to the new school facility improvement account. The amounts deposited to the guarantee account are shown in this revenue source.

Distribution Chart:

State Special Revenue Fund

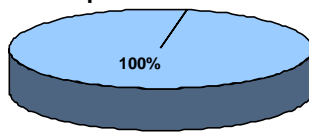

Collection Frequency: Revenue is received monthly, however, distribution to the state special revenue fund takes place three times per year.

% of Total General Fund Revenue: N/A

Revenue Estimate Methodology:

The estimate for interest and income from the common school trust is conducted with the goal of deriving the net amount of revenue that will be deposited to the guarantee account. This means that in addition to estimating the various revenues from the common school trust, estimates of the various diversions that reduce the amount of revenue deposited to the guarantee account must also be estimated. Therefore, the estimated amounts shown for this revenue source are not total revenues, but are net of diversions.

Data

Data from the state accounting system (SABHRS) provide a history of each individual interest and income revenue component from which estimates can be made. Department of Natural Resources and Conservation (DNRC) annual reports provide additional information such as mineral prices and production. Budget submissions on the state budgeting system (MBARS) provide anticipated amount of diversions. DNRC personnel are contacted for their views on potential future factors that may influence revenues such as easement sales, changes in grazing and agricultural rentals, and timber harvest volumes. Global Insight provides future estimates of West Texas Intermediate oil and national well head natural gas prices.

Analysis

The estimate is derived by first estimating the revenue components and then estimating the amounts of the diversions.

Legislative Fiscal Division

Revenue Estimate Profile

Common School Interest and Income

Revenue Components

- Agricultural Fees – Fees are based on a crop share basis. Commodity prices are expected to be higher than FY 2008 resulting in greater returns. DNRC personnel anticipate that overall revenue will be about \$1.0 million more than FY 2008 levels (see the figure below). Based on this information, revenues are increased in FY 2009 and remain constant through FY 2010 and FY 2011.
- Timber – Estimates of timber harvest revenue from common school trust lands are taken directly from DNRC estimates provided in October 2008.
- Oil & Gas Bonuses – With record highs in energy prices, competition to obtain mineral leases has increased, resulting in large bonus payments. A single large one-time bonus payment of \$10.6 million has already been received in FY 2009. All years contain a base amount of \$2.2 million that was received in FY 2008.

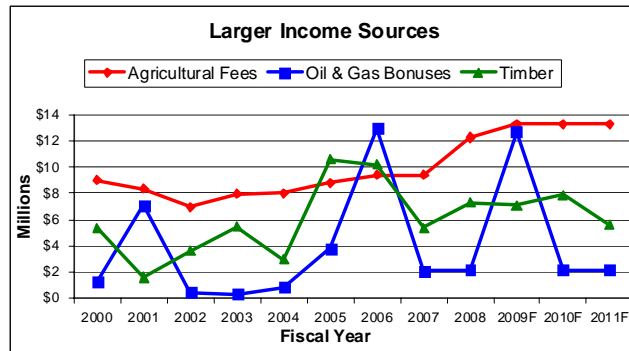

- Grazing Fees – Rates are tied to the price of cattle. Cattle prices are expected to be close to those experienced in FY 2008, perhaps slightly less. DNRC personnel anticipate the grazing fee revenue will be similar to FY 2008.
- Oil & Gas Leases – For each fiscal year estimated, an average annual growth rate over the previous eight year period was applied beginning with FY 2008 collections.
- Oil & Gas Penalties – For each fiscal year estimated, the ratio of the previous year's penalties to the previous year's oil and gas lease revenue was multiplied by that year's estimate for oil and gas lease revenue.
- Miscellaneous Rentals – The estimate involves two parts: a) in FY 2008, Avista signed an agreement to pay rent for hydroelectric generation projects of \$4.0 million each year increased by the rate of inflation in each subsequent year; and b) the remaining small income base components are estimated together by using an average annual growth rate over the previous two year period beginning with FY 2008 collections, excluding the Avista rents.
- Short-term Investment Pool (STIP) – Because revenue initially deposited in the common school trust is invested on a short-term basis (about one month) before being invested in the T & L fund, a short-term rate is used to calculate the earnings. The short-term rate is a composite of Global Insight forecasts for the 3-month commercial paper, 3-month treasury bill, and 6-month treasury bill rates and is estimated to be 1.5 percent in FY 2009, 1.7 percent in FY 2010, and 3.2 percent in FY 2011.

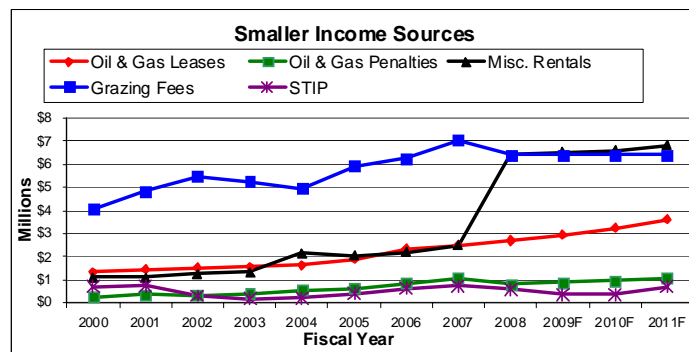

Legislative Fiscal Division

Revenue Estimate Profile

Common School Interest and Income

- Mineral Royalties – Mineral royalties are received from the mining of oil, natural gas, coal, sand and gravel, and other smaller sources. Due to the passage of SB 495 by the 2001 legislature effective FY 2002, mineral royalties are considered distributable income until a net amount (net of diversions that fund trust land administration) of \$138.9 million has been distributed. After that time, mineral royalties will again be deposited to the common school trust and will become part of the trust corpus. The additional corpus will generate additional earnings. It is expected that the effects of SB 495 will terminate in FY 2010. The figure below shows total mineral royalties since FY 2002. The estimate for mineral royalties is obtained by multiplying together estimates for production, price, and the applicable royalty rate.
 - Production – Oil and natural gas production is estimated by increasing the previous fiscal year’s production by the growth rate obtained from a two-year average of the estimates for statewide oil and natural gas production (see the Oil and Natural Gas Production Tax profile). Coal production on state lands comes primarily from a single coal company with minor amounts from another company. Calendar year information on projected production and percentage of production on state lands was obtained by surveying coal companies, including the companies producing on state lands, from which the amount of production on state lands is derived. Fiscal year production is obtained by averaging production for the current and previous calendar years. All other mineral production was held constant at the amount of gravel royalty collection in FY 2008.
 - Price – Oil prices are calculated by increasing the previous year’s Montana price by the growth between the average West Texas Intermediate price estimates obtained from Global Insight for the four quarters of the same fiscal years. The same methodology is used for natural gas with the driving factor being the Global Insight estimated national well head price. Coal price is determined by increasing the previous fiscal year’s price by a growth rate obtained from a two-year average of the calendar year estimates for Montana coal prices (see the Coal Severance Tax profile).
- Trust and Legacy Earnings – The monetary assets of the common school trust are pooled with monetary assets of other land trusts (termed “Trust and Legacy”) and invested by the Board of Investment in the trust funds bond pool. Based on the number of share each trust owns, a share of the earnings is deposited in each trust. For the common school trust, the actual FY 2008 share of 92.64 percent is used. The pool balance grows when permanent revenue is deposited from the various land trust, including the common school trust. DNRC personnel state that no substantial sales of right-of-ways (a source of permanent revenue) are anticipated in the three fiscal years. However, due to the anticipated ending of SB 495 in FY 2010, mineral royalties (permanent revenue) will once again add to the balance. The estimation of the total pool earnings is a three stage process:
 - Earnings from new deposits – New deposits in the pool are estimated to be \$1.6 million in FY 2009, \$8.5 million in FY 2010, and \$22.6 million in FY 2011. Of the total additions in FY 2010-FY2011, \$28.0 million (\$6.7 million in FY 2010 and \$21.3 million in FY 2011) is from mineral royalties being deposited to the trust due to the end of SB 495. This additional money initially earns interest at the short-term rate (1.5 percent for FY 2009, 1.7 percent for FY 2010, and 3.2 percent for FY 2011) before it is invested in a longer term investment (5.5 percent for FY 2009, 5.5 percent for FY 2010, and 5.7 percent for FY 2011). Also included in these calculations are short-term earnings from the estimated \$4.1 million average balance in the common school Land Bank Trust Fund.
 - Earnings from existing balance – The TFBP balance in FY 2008 was \$439.2 million. These funds have been invested in bonds purchased over the past several years with an average return 5.6 percent.
 - Non-portfolio earnings – Money not invested in the trust funds bond pool earns interest at the short-term rate of 1.7 percent for FY 2009, 2.0 percent for FY 2010, and 4.0 percent for FY 2011 percent on a balance of \$2.5 million, the actual balance in FY 2008.

Once the total amount of the pool earnings has been estimated by summing the above three items, the common school share of 92.64 percent is applied.

Legislative Fiscal Division

Revenue Estimate Profile

Common School Interest and Income

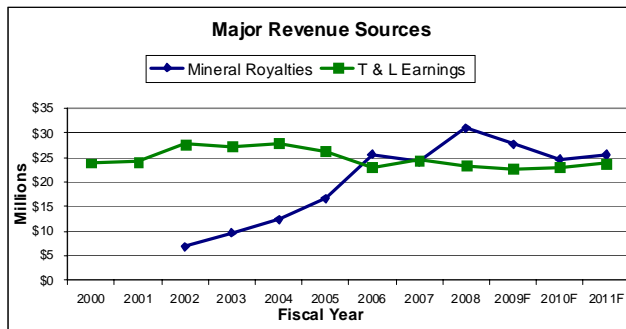

Diversions

Diversions fund operational costs in DNRC, but reduce the amount of revenue distributed to the trust beneficiaries (see the figure below). To determine future diversion amounts, DNRC's present law budget amounts are used.

- Trust Land Administration Account – Of the total expenditures requested to be made from this account, a percentage of the expenditures are funded by common school trust revenue. A portion of mineral royalties and permanent income is diverted to this account to fund department's activities in managing the common school trust lands. The portion of permanent revenue is determined by multiplying the amount of permanent revenue by the ratio of permanent revenue to the sum of mineral royalties and permanent revenue. Mineral royalty revenue funds the remainder of the expenditures.
- Timber Sales Account – A portion of timber sale revenue from the common school trust is used to fund costs associated with the timber sale program on the trust lands. Other trusts with timber revenue also pay into this account. The portion each pays is the ratio of its timber sale revenue to the total state-wide timber sale revenue multiplied by the total cost of the program. In FY 2008, the common school trust funded 74.4 percent of total expenditures.
- Resource Development Account – Three percent of all income (excluding commercial lease income) from the common school trust is diverted to an account to fund resource development on the trust lands. Interest earnings are not included in the calculations.
- Commercial Leasing Account – Ten percent of revenue received from commercial leases is diverted to an account to fund activities associated with administering the leases.

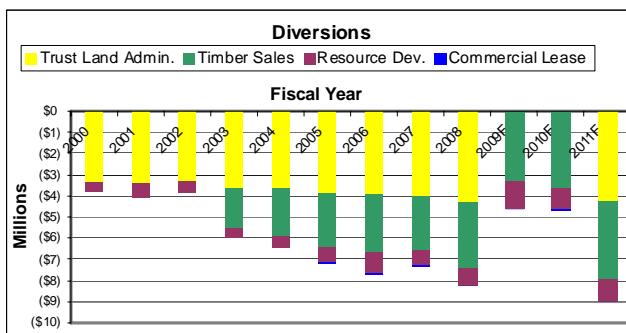

Adjustments and Distribution

Once total revenue and total diversions have been estimated, the net amounts are distributed:

- 95 percent of the net amount of interest and income (including the Avista amount), excluding timber and mineral royalties, is deposited to the guarantee account and the remaining 5 percent is returned to the trust. The money deposited to the guarantee account is used for public schools.
- The value received from timber sales over 18 million board feet is distributed to the guarantee account to fund school technology. The amount of money distributed to the account in one year is spent in the next year.
- The remaining amount of timber (if any) is distributed 95 percent to the guarantee account and 5 percent is returned to the trust. The money deposited to the guarantee account is used for public schools.
- From FY 2009 to part way through FY 2010, mineral royalties are used for fund administrative costs with the remainder distributed to the guarantee account and then transferred to the school facility improvement account. Beginning part way through FY 2010, SB 495 ends and mineral royalty revenue net of administration costs becomes part of the permanent trust fund.

Legislative Fiscal Division

Revenue Estimate Profile

Common School Interest and Income

Forecast Methodology:

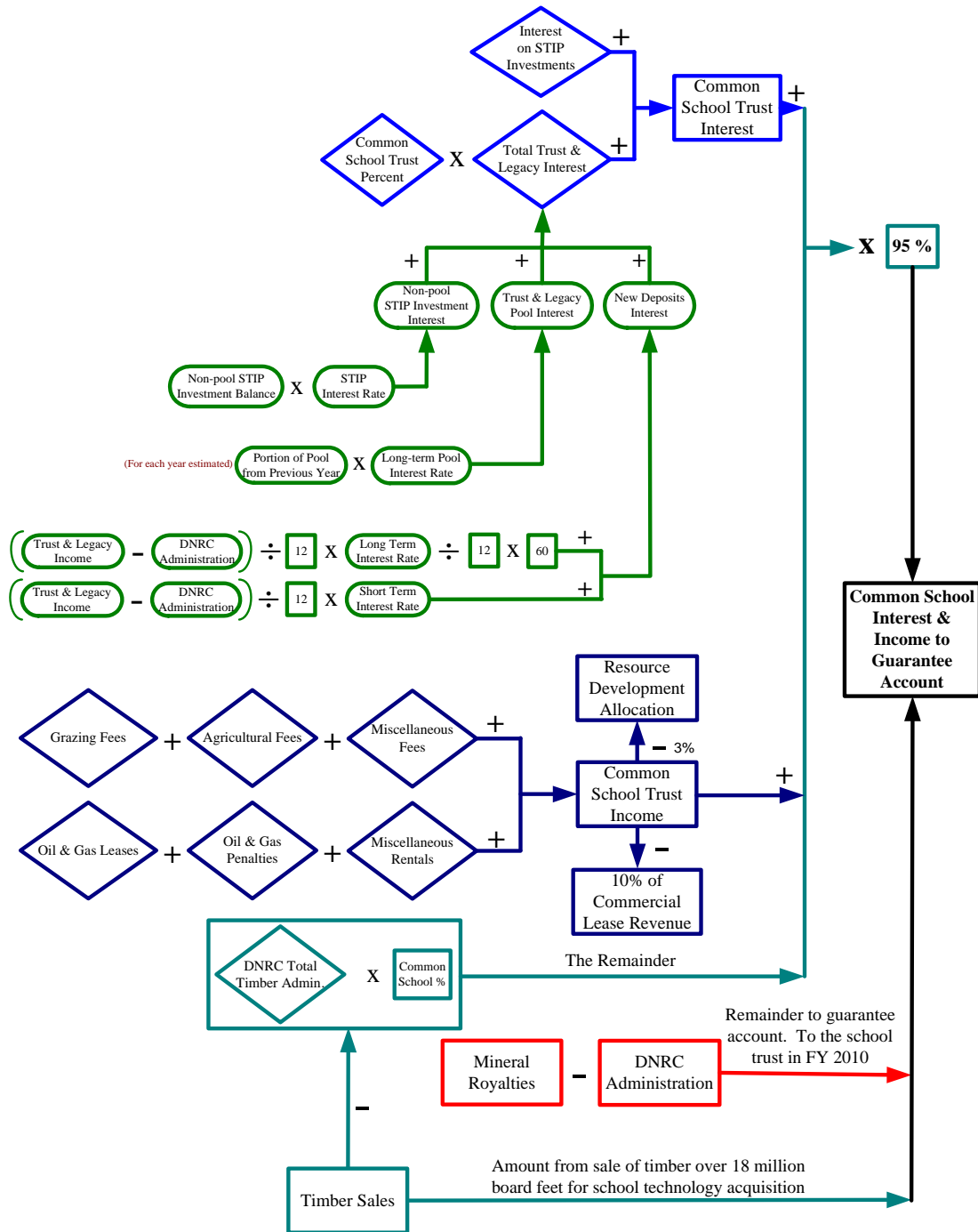

Legislative Fiscal Division

Revenue Estimate Profile

Common School Interest and Income

Revenue Estimate Assumptions:

	t	Total Rev.	GF Rev.	TFBP	STIP	Common	SB495	Trust Land
	<u>Fiscal</u>	<u>Millions</u>	<u>Millions</u>	<u>Interest</u>	<u>Interest</u>	<u>School Share</u>	<u>Loan Pay.</u>	<u>Expense</u>
				<u>Millions</u>	<u>Millions</u>	<u>T&L</u>	<u>Millions</u>	<u>Millions</u>
Actual	2000	44.296034	44.296034			0.938562		
Actual	2001	46.845895	46.845895			0.923235		
Actual	2002	50.875186	48.937673	29.627056	0.102664	0.932906		
Actual	2003	48.977342	0.000000	29.146744	0.068370	0.931091	0.000000	-3.551119
Actual	2004	55.663022	0.000000	30.087011	0.053502	0.928698	-1.820816	-3.311911
Actual	2005	68.035764	0.000000	28.106281	0.269698	0.927050	-2.650063	-3.679601
Actual	2006	82.605539	0.000000	24.428206	0.408162	0.928000	-10.848961	-3.904704
Actual	2007	70.428669	0.000000	26.206838	0.267652	0.926977	-19.473459	-3.130197
Actual	2008	83.025650	0.000000	25.159580	0.128925	0.926420	-11.573605	-3.808804
Forecast	2009	88.354000	0.000000	24.474900	0.076364	0.926420	0.000000	-4.338963
Forecast	2010	70.091000	0.000000	24.552355	0.250056	0.926420	0.000000	-4.284315
Forecast	2011	55.764000	0.000000	25.005341	0.696125	0.926420	0.000000	-4.308072

	t	Trust Income	New Deposit	Non Pool	Non Pool	SB495
	<u>Fiscal</u>	<u>New Deposit</u>	<u>Long Term</u>	<u>STIP</u>	<u>STIP Bal</u>	<u>Interest</u>
		<u>Millions</u>	<u>Rate</u>	<u>Rate</u>	<u>Millions</u>	<u>Millions</u>
Actual	2000	10.969295	7.0160%	5.4290%	11.676486	
Actual	2001	12.667780	6.8850%	4.7390%	6.984553	
Actual	2002	2.348339	6.3380%	2.5650%	7.334239	
Actual	2003	2.363355	5.7290%	1.3600%	6.242273	
Actual	2004	2.971526	5.3650%	1.2650%	7.049634	
Actual	2005	1.457756	5.1940%	2.3870%	12.106697	-3.005668
Actual	2006	1.425106	5.2340%	4.0770%	3.862666	-2.255822
Actual	2007	7.173844	5.4050%	4.7290%	14.953757	-1.505159
Actual	2008	3.101654	5.3790%	3.1940%	2.461097	-0.282977
Forecast	2009	1.410837	5.4900%	1.4970%	2.461097	0.000000
Forecast	2010	8.269190	5.4780%	1.6830%	2.461097	0.000000
Forecast	2011	22.455124	5.7480%	3.2000%	2.461097	0.000000

	t	Grazing	Agriculture	Misc.	O&G Lease	O&G Bonus	O&G Penalty	Misc.
	<u>Fiscal</u>	<u>Millions</u>	<u>Millions</u>	<u>Millions</u>	<u>Millions</u>	<u>Millions</u>	<u>Millions</u>	<u>Millions</u>
Actual	2000	4.065911	9.053155	0.000000	1.328220	1.277231	0.261334	1.127779
Actual	2001	4.850839	8.376539	0.000000	1.448285	7.118093	0.355322	1.121433
Actual	2002	5.467322	6.998644	0.000000	1.540472	0.478224	0.334699	1.243778
Actual	2003	5.243241	7.974945	0.000000	1.575356	0.300943	0.399347	1.348894
Actual	2004	4.970961	8.051131	0.000000	1.648808	0.870693	0.533758	2.156382
Actual	2005	5.918241	8.816342	0.000000	1.893296	3.826961	0.640759	2.057478
Actual	2006	6.276945	9.453271	0.000000	2.330531	13.005123	0.864068	2.193452
Actual	2007	7.057412	9.408029	0.000000	2.506340	2.101872	1.066758	2.510437
Actual	2008	6.407660	12.282064	0.000000	2.700962	2.153575	0.812454	6.417877
Forecast	2009	6.407660	13.282064	0.000000	2.952465	12.712218	0.888107	6.523761
Forecast	2010	6.407660	13.282064	0.000000	3.240010	2.153575	0.974601	6.614976
Forecast	2011	6.407660	13.282064	0.000000	3.591572	2.153575	1.080351	6.822123

Legislative Fiscal Division

Revenue Estimate Profile

Common School Interest and Income

	t	Int. Land	Int. STIP	Int. Trust	Timber	Res. Dev.	Commercial
	Fiscal	Millions	Millions	Millions	Millions	Millions	Lease Millions
Actual	2000	0.000566	0.706653	23.905761	5.379555	-0.513416	
Actual	2001	0.000290	0.715090	24.206450	1.623592	-0.698124	
Actual	2002	0.000063	0.305319	27.775111	3.624785	-0.504023	
Actual	2003	0.019744	0.188794	27.201941	3.605510	-0.499362	
Actual	2004	0.002900	0.199526	27.991422	0.666749	-0.517845	
Actual	2005	0.025797	0.408384	26.305944	3.651789	-0.686492	-0.067175
Actual	2006	0.000000	0.641609	23.048141	2.878508	-1.003369	-0.067975
Actual	2007	0.000000	0.733359	24.541243	1.929315	-0.722384	-0.057113
Actual	2008	0.000000	0.605693	23.427775	2.250670	-0.785520	-0.057002
Forecast	2009	0.000000	0.357006	22.744782	1.716365	-1.282988	-0.040000
Forecast	2010	0.000000	0.357897	22.977450	1.503134	-0.980187	-0.040000
Forecast	2011	0.000000	0.696768	23.810352	1.053701	-1.000120	-0.040000

	t	Total	Timber	School	Oil	Gas	Coal	Other
	Fiscal	Timber	Sales Pgm.	Technology	Royalties	Royalties	Royalties	Royalties
		Millions	Millions	Millions	Millions	Millions	Millions	Millions
Actual	2000	5.379555	0.000000	0.000000				
Actual	2001	1.623592	0.000000	0.000000				
Actual	2002	3.624785	0.000000	1.822162	2.390492	1.523062	2.836919	0.144369
Actual	2003	5.507588	-1.829039	0.000000	3.681611	1.995499	3.877054	0.148393
Actual	2004	2.968369	-1.940581	3.178988	4.851597	2.718035	4.676964	0.169754
Actual	2005	10.602272	-2.536323	4.414160	7.965516	4.329847	4.239865	0.194346
Actual	2006	10.227233	-2.707337	4.641388	14.759265	6.317280	4.179503	0.355698
Actual	2007	5.397993	-2.572832	0.895846	15.133322	5.082713	3.729473	0.147955
Actual	2008	7.316574	-3.117074	1.948830	19.366955	5.659708	5.865071	0.156243
Forecast	2009	7.081590	-3.317444	2.047781	15.302895	5.575019	6.645019	0.174296
Forecast	2010	7.882040	-3.656992	2.721914	11.872557	5.951891	6.735539	0.174296
Forecast	2011	5.575023	-3.721768	0.799554	11.884111	6.355867	7.152580	0.174296

	t	Oil	Gas	Coal	Oil	Gas	Coal	Excess
	Fiscal	Production	Production	Production	Price	Price	Price	Royalties
		Barrels	MCF's	Tons	\$/Barrel	\$/MCF	\$/Ton	To Trust
Actual	2000	0.923777	5.050552	3.273552	22.670000	1.880000	11.650000	
Actual	2001	0.889786	6.294741	2.252935	26.470000	3.930000	12.000000	
Actual	2002	0.911057	5.892287	2.758351	20.320000	1.910000	11.800000	
Actual	2003	1.017463	5.380950	3.689490	28.140000	3.200000	9.590000	
Actual	2004	1.122987	5.720200	4.183187	31.020000	3.950000	8.600000	
Actual	2005	1.400063	7.240046	3.914410	44.690000	5.090000	9.120000	
Actual	2006	2.024282	7.878173	4.212862	57.240000	6.640000	8.630000	
Actual	2007	2.012340	7.708192	3.006455	55.850000	5.130000	9.550000	
Actual	2008	1.808692	7.751961	4.720487	88.870000	6.120000	10.870000	
Forecast	2009	1.752763	7.897918	4.668500	67.159437	5.647077	11.386988	0.000000
Forecast	2010	1.688904	7.964916	4.259000	54.074926	5.978108	12.651870	6.746976
Forecast	2011	1.566440	7.852931	4.216000	58.359235	6.474899	13.572259	21.258782

Total Rev. = (Grazing + Agriculture + O&G Lease + O&G Bonus + O&G Penalty + Misc. + Int. Land + Int. Stip + Int. Trust + Timber + Res. Dev. + Commercial Lease) * .95 + Oil Roy. + Gas Roy + Coal Roy. + Other Roy. + School Technology + Trust Land Admin. - Excess Royalties To Trust

Legislative Fiscal Division

Revenue Estimate Profile

Common School Interest and Income

Revenue Projection:

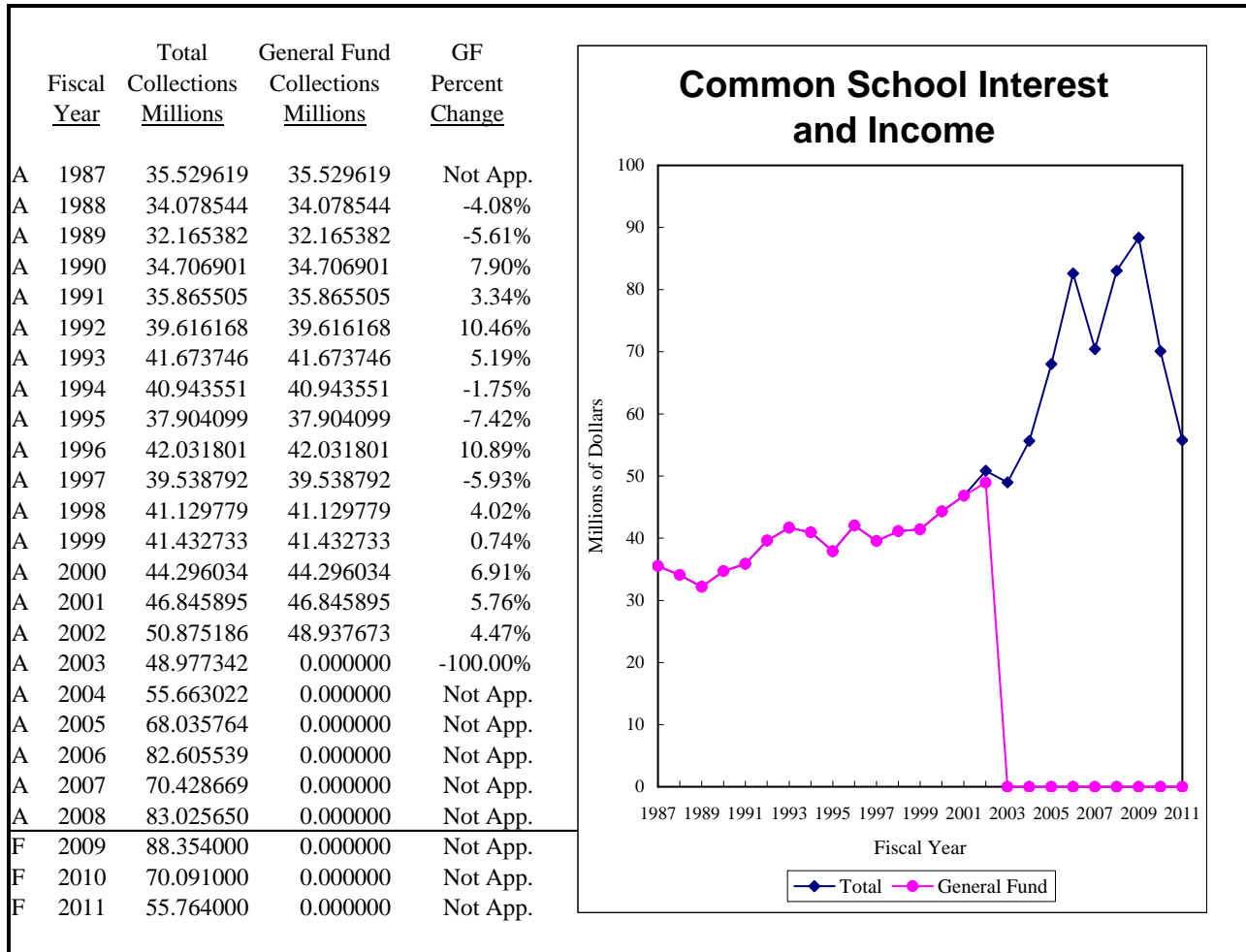

Data Source(s): Board of Investments, DNRC - Centralized Services, SABHRS, *Wall Street Journal*, Global Insight

Contacts: Department of Natural Resources and Conservation

Legislative Fiscal Division

Revenue Estimate Profile

Cultural Trust Interest

Revenue Description: Beginning in fiscal 1976, a portion of coal severance tax revenue was deposited into the Parks Acquisition and Arts Protection trust fund. The 1991 legislature split the principal of this trust into two separate trusts, the Parks Acquisition trust and the Arts Protection trust (cultural trust), with coal severance taxes allocated to each one. The 1997 legislature appropriated \$3.9 million from the cultural trust fund for the immediate purchase of Virginia and Nevada City properties. This action resulted in a loss of trust interest revenue that otherwise would be used to fund cultural and aesthetic (C&A) projects in the state during the 1999 biennium. Thus, beginning July 1, 1997, and ending June 30, 1999, 0.87 percent in coal severance tax revenue was allocated to an account in the state special revenue fund to compensate for the lost interest earnings and the previous 0.63 percent distribution of coal severance tax to the cultural trust was eliminated. Except for fiscal 2003, beginning July 1, 1999, the amount of 0.63 percent is once again statutorily allocated to the cultural trust, the interest from which is to be used for the purpose of protection of works of art in the capitol and for other cultural and aesthetic projects. The August 2002 special legislative session eliminated the allocation for fiscal 2003 only. In HB 9, the 2005 Legislature transferred \$3,412,500 from the general fund to the trust and the 2007 Legislature transferred \$1,500,000 from the general fund to the trust. Both these actions increase the earnings from the trust.

Statutory Reference:

Tax Rate - NA
Distribution (MCA) - 15-35-108(6), 22-2-305
Date Due - NA

Applicable Tax Rate(s): N/A

Distribution: All income from the trust is deposited in a state special revenue fund to be appropriated for protection of works of art in the state capitol and for other cultural and aesthetic projects.

Distribution Chart:

State Special Revenue Fund

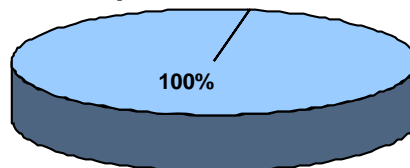

Collection Frequency: Monthly

% of Total General Fund Revenue: N/A

Revenue Estimate Methodology:

Data

The data used to estimate the interest and earnings of the cultural trust are collected from the Board of Investments (BOI), Global Insight, and the state accounting system (SABHRS). The BOI provides historic interest earnings from the trust as well as the gains and losses from the sale of investment instruments. Projections of interest rates are provided by Global Insight, and historic earnings are provided from SABHRS. No adjustments are required on the raw data in preparation for analysis.

Analysis

The cultural trust, formed in the late 1970's, was created from distributions of the coal severance tax. The cultural trust receives coal tax distributions at the rate of 0.63 percent of the total tax. In several years of budget stress, the coal tax distribution to the cultural trust was temporarily eliminated or reduced. The principal of the trust was reduced by \$3.9 million in fiscal 1997 and the funds were used for the purchase of Virginia and Nevada Cities. In fiscal 2006, the trust was reimbursed for \$3.4 million,

Legislative Fiscal Division

Revenue Estimate Profile

Cultural Trust Interest

substantially increasing the principal of the trust. The principal or corpus of the cultural trust now stands at \$10.6 million, as demonstrated by the line in the figure below. Estimates of future deposits to the cultural trust are developed in the coal severance tax projection and are expected to be \$279,000 in fiscal 2009, \$290,000 in fiscal 2010, and \$304,000 in fiscal 2011.

To forecast the cultural trust interest earnings, each of three interest/income components are estimated independently and combined. The estimated interest/income components include:

- The trust funds bond pool (TFBP)
- The short term investment pool (STIP)
- New trust deposits

The TFBP was formed in 1995 to manage the fixed investments held in the state's major trust funds. TFBP earnings are the largest source of earnings for the trust. The TFBP earnings are estimated by applying a long-term interest rate to the projected TFBP balance. The applicable long term rate is an average of four rates projected by Global Insight and includes the corporation Aaa bond rate, the corporate Baa bond rate, the rate on 10-year treasury bonds, and the rate on 30-year treasury bonds. The average rate is then factored to produce a fiscal year average rate. The fiscal year average long-term interest rate is expected to be 5.5 percent in fiscal years 2009 and 2010 and 5.7 percent in fiscal year 2011.

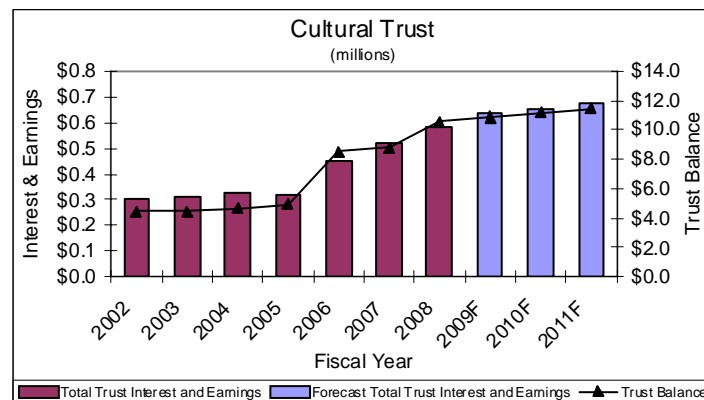

STIP interest is earned on the temporary investment of trust funds. Funds are acquired from activities such as new deposits and investment sales. Funds are held in STIP until the BOI determines that conditions are favorable for deposit in the TFBP. To estimate future STIP earnings, an average short-term interest rate is developed, based on Global Insight projections of the interest rates on three and six-month corporate loans and three and six-month treasury bills. The average rates are then factored to a fiscal year average rate. The average fiscal year short-term interest rate is expected to be 1.5 percent in fiscal year 2009, 1.7 percent in fiscal year 2010, and 3.2 percent in fiscal year 2011.

The 0.63 percent coal severance tax distribution to the cultural trust is considered new deposits. New deposits are transferred to the trust on a quarterly basis. When the BOI receives the coal tax transfer, the funds are immediately invested in STIP. Funds are expected to remain in STIP for one month before being invested in the TFBP. The interest earned on new deposits is estimated by summing STIP earnings for one month with TFBP earnings for the remainder of the year.

Legislative Fiscal Division

Revenue Estimate Profile

Cultural Trust Interest

Forecast Methodology:

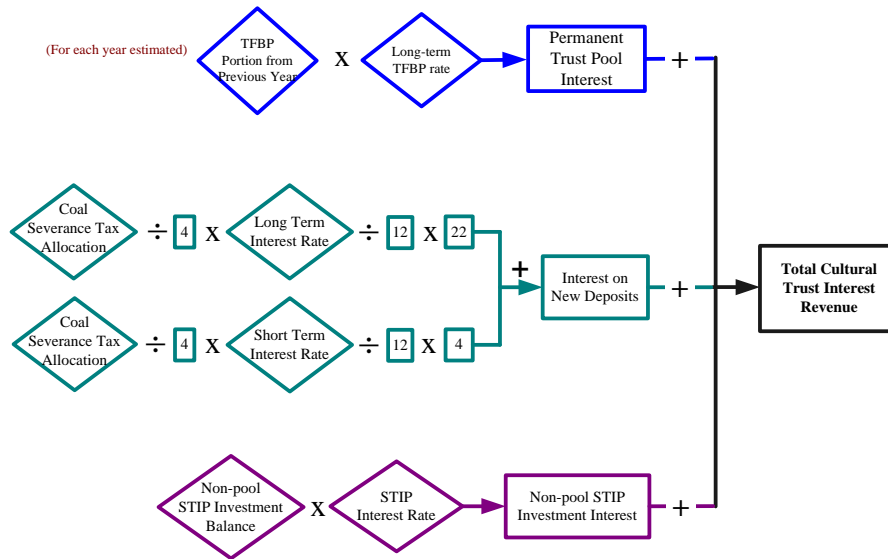

Revenue Estimate Assumptions:

	t	Total Rev.	GF Rev.	TFBP	STIP	Invested	Average
	Fiscal	Millions	Millions	Interest	Interest	Balance	Return
				Millions	Millions	Millions	Rate
Actual	2000	0.253951	0.000000				
Actual	2001	0.286146	0.000000				
Actual	2002	0.305355	0.000000	0.304397	0.000957		
Actual	2003	0.314131	0.000000	0.310495	0.001135	4.518165	0.069526
Actual	2004	0.325684	0.000000	0.324526	0.001158	4.693455	0.069391
Actual	2005	0.318333	0.000000	0.316149	0.002184	4.932287	0.064541
Actual	2006	0.447040	0.000000	0.421171	0.025868	8.478110	0.052729
Actual	2007	0.515699	0.000000	0.512569	0.003130	8.784502	0.058706
Actual	2008	0.584045	0.000000	0.572852	0.011193	10.595200	0.055124
Forecast	2009	0.634000	0.000000	0.623158	0.010651	11.159791	0.056794
Forecast	2010	0.650000	0.000000	0.638475	0.011543	11.449791	0.056771
Forecast	2011	0.671000	0.000000	0.654361	0.016454	11.753791	0.057072

	t	Net Coal Tax	New Deposit	Non Pool	Non Pool
	Fiscal	New Deposit	Long Term	STIP	STIP Bal
		Millions	Rate	Rate	Millions
Actual	2000	0.212426	7.0160%	5.4290%	0.249639
Actual	2001	0.203724	6.8850%	4.7390%	0.028633
Actual	2002	0.199168	6.3380%	2.5650%	0.102287
Actual	2003	0.000000	5.7290%	1.3600%	0.062902
Actual	2004	0.198731	5.3650%	1.2650%	0.088412
Actual	2005	0.237097	5.1940%	2.3870%	0.092433
Actual	2006	0.225676	5.2340%	4.0770%	0.063498
Actual	2007	0.256780	5.4050%	4.7290%	0.060001
Actual	2008	0.285591	5.3790%	3.1940%	0.190851
Forecast	2009	0.279000	5.4900%	1.4970%	0.190851
Forecast	2010	0.290000	5.4780%	1.6830%	0.190851
Forecast	2011	0.304000	5.7480%	3.2000%	0.190851

Total Rev. = Invested Balance * Average Return

Legislative Fiscal Division

Revenue Estimate Profile

Cultural Trust Interest

Revenue Projection:

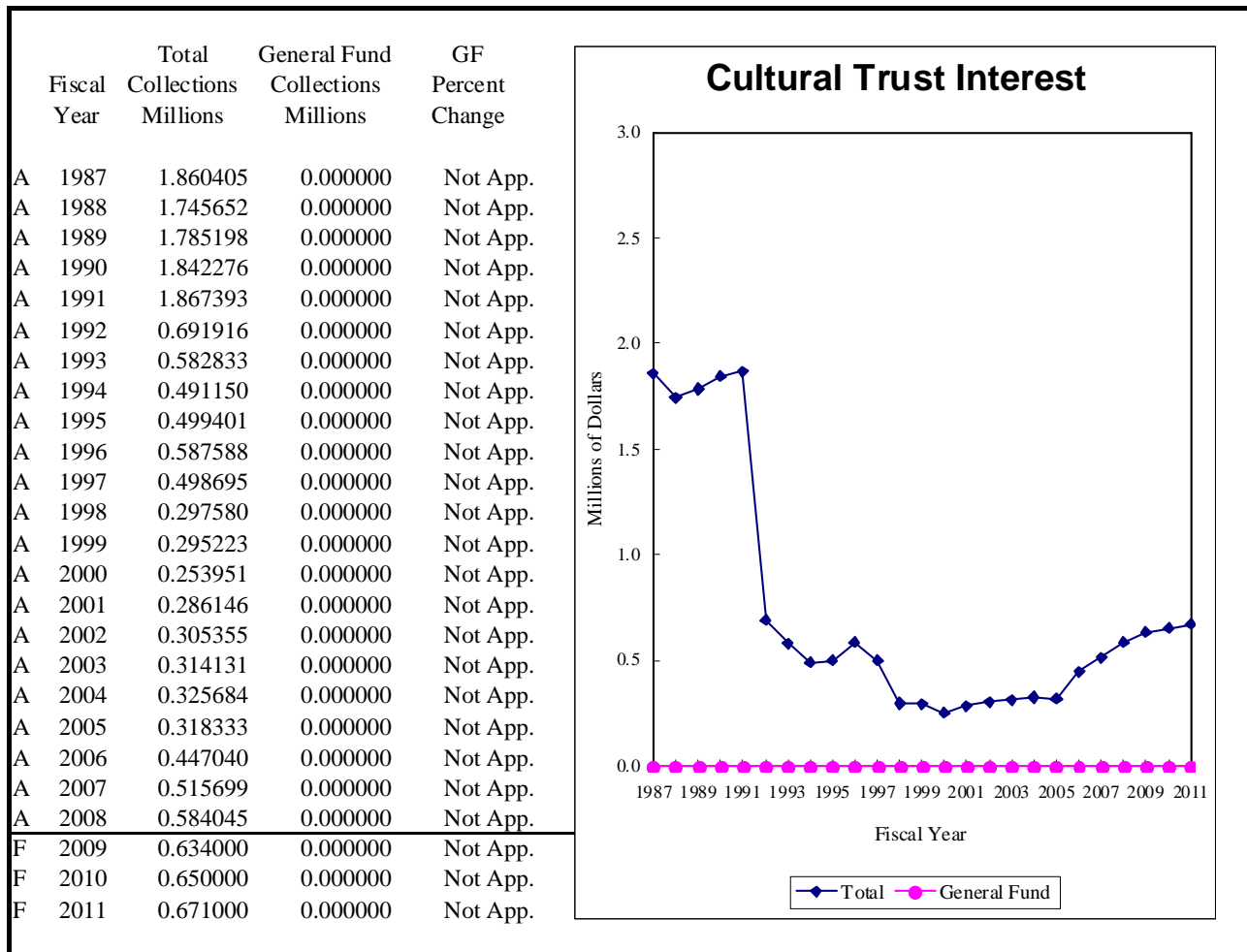

Data Source(s): Board of Investments, SABHRS, *Wall Street Journal*, Global Insight

Contacts:

Legislative Fiscal Division

Revenue Estimate Profile

Deaf and Blind Trust Interest and Income

Revenue Description: Lands granted by the federal government to the state for the benefit of public schools and various state institutions generate income. These lands produce revenue through rents or crop shares for agricultural purposes, royalties from the sale of mineral rights, and sales of timber. Income from certain portions of public school/institution lands has been designated for support of the School for the Deaf and Blind. Thus, some of these funds are deposited into a component of the trust and legacy trust fund referred to as the Deaf and Blind trust, which generates interest earnings for the state. As of October 1, 1995, all fixed-income investments held by the state's major trust funds were transferred to a newly-created Trust Funds Bond Pool (TFBP). The majority of trust and legacy trust funds are invested as part of the TFBP. Some funds, however, are invested on a short-term basis in the state's Short Term Investment Pool (STIP). The state constitution prohibits the investment of the permanent trust in common stock.

In accordance with statute, 3.0 percent of Deaf and Blind trust interest and income is diverted to the Department of Natural Resources and Conservation (DNRC) to be used for resource development purposes. Senate Bill 48, passed by the 1999 legislature, provides for the diversion of the following funds for the purpose of funding the Trust Land Management Division in the DNRC: 1) mineral royalties; 2) revenues from the sale of easements; and 3) 5.0 percent of interest and income previously credited to the common school trust. In addition, a portion of timber sale revenue is diverted to fund a portion of DNRC's timber program. The amount of the money diverted from the Deaf and Blind trust reduces the growth of the trust fund balance and, hence, reduces the amount of distributable interest earnings.

Statutory Reference:

- Tax Rate – NA
- Distribution (MCA) – 20-8-110
- Enabling Act, Sections 11 & 17
- Other (MCA) – DNRC trust land administration diversion (77-1-109)
- DNRC timber sale program diversion (77-1-613)
- DNRC land bank administration diversion (77-2-362)
- DNRC resource development diversion (77-1-607)
- DNRC commercial lease diversion (77-1-905)

Applicable Tax Rate(s): N/A

Distribution: Interest and income from the trust, net of amounts to fund DNRC administration, are allocated to the School for the Deaf and Blind.

Distribution Chart:

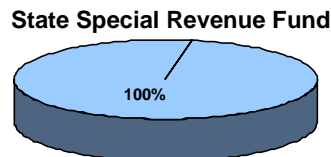

Collection Frequency: Monthly

% of Total General Fund Revenue: N/A

Revenue Estimate Methodology:

The estimate for interest and income from the Deaf and Blind trust is conducted with the goal of deriving the net amount of revenue that will be distributed to the trust beneficiary. This means that in addition to estimating the various distributable revenues from the trust, estimates of the various diversions that reduce the amount of distributable revenue must also be estimated. Therefore, the estimated amounts shown for this revenue source are not total revenues, but are net of diversions.

Legislative Fiscal Division

Revenue Estimate Profile

Deaf and Blind Trust Interest and Income

Permanent revenue (revenue that is not distributed, but remains in the trust such as from timber and mineral royalties), is estimated as part of the entire Trust and Legacy account (T & L) and earnings are apportioned to this trust according to the number of shares owned.

Data

Data from the state accounting system (SABHRS) provide a history of each individual interest and income revenue component from which estimates can be made. Department of Natural Resources and Conservation (DNRC) annual reports provide additional information such as mineral prices and production and timber estimates. Budget submissions on the state budgeting system (MBARS) provide anticipated amount of diversions.

Analysis

The estimate is derived by first estimating the distributable revenue components and then estimating the amounts of the diversions.

Revenue Components

- Trust and Legacy Earnings (see the figure below) – The monetary assets of the trust are pooled with monetary assets of other land trusts in the T & L and invested by the Board of Investment in the trust funds bond pool. Based on the number of share each trust owns, a share of the earnings is deposited in each trust. For the Deaf and Blind trust, the actual FY 2008 share percentage of 0.79 is used. The estimation of the total pool earnings is a three stage process:
 - Earnings from new deposits – New deposits in the pool are estimated to be in \$1.6 million in FY 2009, \$8.5 million in FY 2010 and \$22.6 million in FY 2011. This additional money initially earns interest at the short-term rate (1.5 percent in FY 2009, 1.7 percent in FY 2010, and 3.2 percent in FY 2011) before it is invested in a longer term investment (5.5 percent in FY 2009, 5.5 percent in FY 2010, and 5.7 percent in FY 2011).
 - Earnings from existing balance – The pool balance in FY 2008 was \$439.2 million. The majority of these funds have been invested in bonds purchased over the past several year and average a return rate of 5.6 percent.
 - Non-portfolio earnings – Money not invested in the trust funds bond pool earns interest at the short-term rate of 1.7 in FY 2009, 2.0 percent in FY 2010, and 4.0 percent in FY 2011 on a balance of \$2.5 million, the actual balance from FY 2008.

Once the total amount of the pool earnings has been estimated by summing the above three items, the Deaf and Blind trust share of 0.79 percent is applied.

- Grazing Fees – Rates are tied to the price of cattle. Cattle prices are expected to be close to those experienced in FY 2008, perhaps slightly less. DNRC personnel anticipate the grazing fee revenue will be similar to FY 2008.

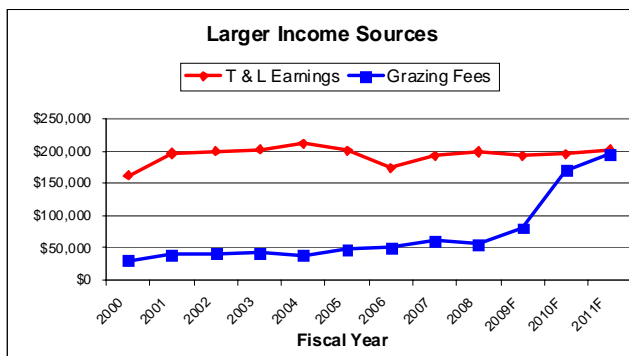

- Miscellaneous Rentals - These are small income components that are combined and estimated together. For each fiscal year estimated, the estimate is based on the growth rate between FY 2002 and FY 2008.
- Agricultural Fees – Fees are based on a crop share basis. Commodity prices are expected to be higher than FY 2008 resulting in greater returns. DNRC personnel anticipate that overall revenue will be more than FY 2008 levels (see the figure below). Based on this information, revenues are increased in FY 2009 and remain constant through FY 2010 and FY 2011.
- Oil & Gas Leases – For each fiscal year estimated, the estimate is the average of the previous three years.

Legislative Fiscal Division

Revenue Estimate Profile

Deaf and Blind Trust Interest and Income

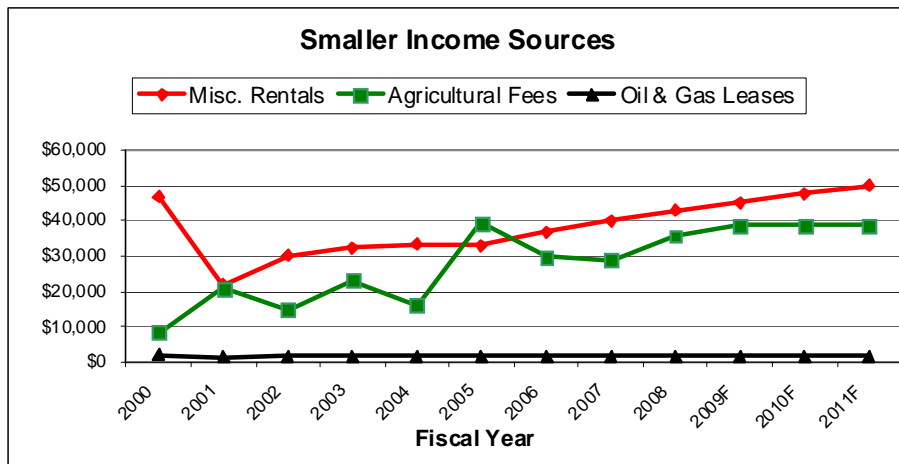

Diversions

Diversions fund operational costs in DNRC, but reduce the amount of revenue distributed to the trust beneficiaries (see the figure below). To determine future diversion amounts, DNRC's present law budget amounts are used. The only diversion that affects distributable revenue is the three percent of all income from the trust that is diverted to an account to fund resource development on the trust lands.

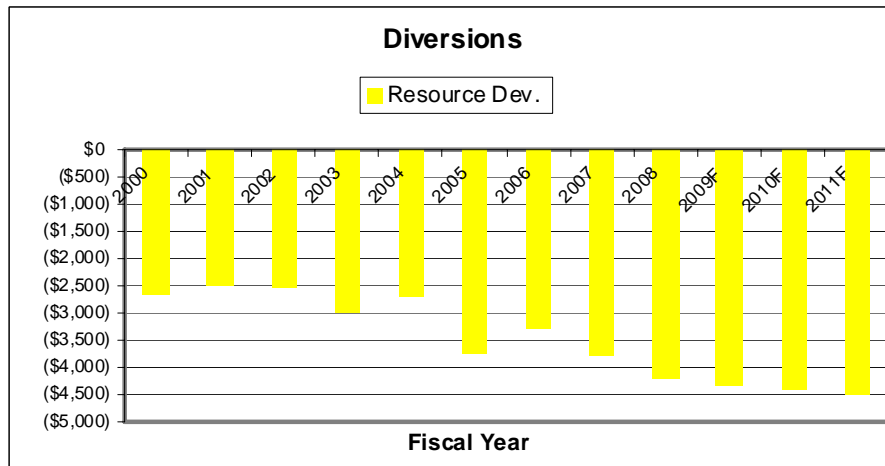

Adjustments and Distribution

Once total revenue and total diversions have been estimated, the net amounts are distributed 100 percent to the state special revenue fund.

Legislative Fiscal Division

Revenue Estimate Profile

Deaf and Blind Trust Interest and Income

Forecast Methodology:

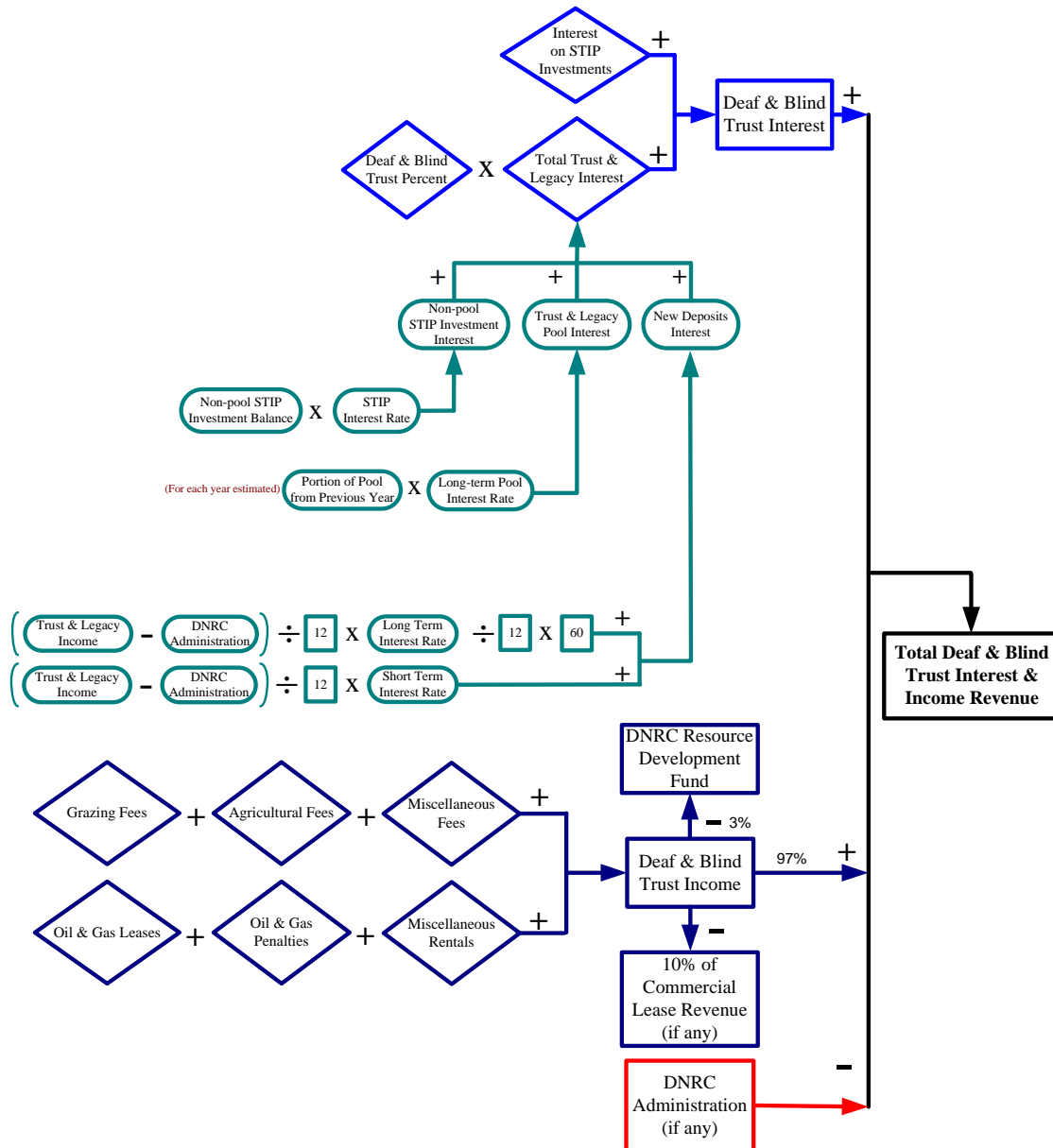

Legislative Fiscal Division

Revenue Estimate Profile

Deaf and Blind Trust Interest and Income

Revenue Estimate Assumptions:

	t	Total Rev.	GF Rev.	TFBP	STIP	Deaf &
	<u>Fiscal</u>	<u>Millions</u>	<u>Millions</u>	<u>Interest</u>	<u>Interest</u>	<u>Blind Share</u>
				<u>Millions</u>	<u>Millions</u>	<u>T&L</u>
Actual	2000	0.251003	0.000000			0.006369
Actual	2001	0.278974	0.000000			0.007485
Actual	2002	0.284290	0.000000	29.627056	0.102664	0.006697
Actual	2003	0.299569	0.000000	29.146744	0.068370	0.006947
Actual	2004	0.299050	0.000000	30.087011	0.053502	0.007029
Actual	2005	0.318818	0.000000	28.106281	0.269698	0.007072
Actual	2006	0.290605	0.000000	24.428206	0.408162	0.007029
Actual	2007	0.323431	0.000000	26.206838	0.267652	0.007275
Actual	2008	0.334289	0.000000	25.159580	0.128925	0.007867
Forecast	2009	0.334000	0.000000	24.474900	0.076364	0.007867
Forecast	2010	0.338000	0.000000	24.552355	0.250056	0.007867
Forecast	2011	0.347000	0.000000	25.005341	0.696125	0.007867

	t	Trust Income	Trust Land	New Deposit	Non Pool	Non Pool
	<u>Fiscal</u>	<u>New Deposit</u>	<u>Admin.</u>	<u>Long Term</u>	<u>STIP</u>	<u>STIP Bal</u>
		<u>Millions</u>	<u>Millions</u>	<u>Rate</u>	<u>Rate</u>	<u>Millions</u>
Actual	2000	10.969295		7.0160%	5.4290%	11.676486
Actual	2001	12.667780	0.000000	6.8850%	4.7390%	6.984553
Actual	2002	2.348339	0.000000	6.3380%	2.5650%	7.334239
Actual	2003	2.363355	0.000000	5.7290%	1.3600%	6.242273
Actual	2004	2.971526	0.000000	5.3650%	1.2650%	7.049634
Actual	2005	1.457756	0.000000	5.1940%	2.3870%	12.106697
Actual	2006	1.425106	0.000000	5.2340%	4.0770%	3.862666
Actual	2007	7.173844	0.000000	5.4050%	4.7290%	14.953757
Actual	2008	3.101654	0.000000	5.3790%	3.1940%	2.461097
Forecast	2009	1.410837	0.000000	5.4900%	1.4970%	2.461097
Forecast	2010	8.269190	0.000000	5.4780%	1.6830%	2.461097
Forecast	2011	22.455124	0.000000	5.7480%	3.2000%	2.461097

	t	Grazing	Agriculture	Misc.	O&G Lease	O&G Bonus	O&G Penalty	Misc.
	<u>Fiscal</u>	<u>Millions</u>	<u>Millions</u>	<u>Millions</u>	<u>Millions</u>	<u>Millions</u>	<u>Millions</u>	<u>Millions</u>
Actual	2000	0.030113	0.008628	0.000000	0.001980	0.001280	0.000000	0.046783
Actual	2001	0.040496	0.020937	0.000000	0.001440	0.000480	0.000000	0.021847
Actual	2002	0.040733	0.014776	0.000000	0.001740	0.000050	0.000000	0.030166
Actual	2003	0.042676	0.022940	0.000000	0.001740	0.000000	0.000000	0.032230
Actual	2004	0.038658	0.016168	0.000000	0.001740	0.000000	0.000000	0.033333
Actual	2005	0.047753	0.039470	0.000000	0.001740	0.000000	0.000000	0.032938
Actual	2006	0.050892	0.029866	0.000000	0.001740	0.000000	0.000000	0.036823
Actual	2007	0.061308	0.028854	0.000000	0.001740	0.000000	0.002650	0.040075
Actual	2008	0.056117	0.035755	0.000000	0.001740	0.000000	0.002900	0.043035
Forecast	2009	0.056117	0.038666	0.000000	0.001740	0.000000	0.002900	0.045276
Forecast	2010	0.056117	0.038666	0.000000	0.001740	0.000000	0.002900	0.047633
Forecast	2011	0.056117	0.038666	0.000000	0.001740	0.000000	0.002900	0.050113

Legislative Fiscal Division

Revenue Estimate Profile

Deaf and Blind Trust Interest and Income

	<u>t</u>	<u>Int. Land</u>	<u>Int. STIP</u>	<u>Int. Trust</u>	<u>Timber</u>	<u>Res. Dev.</u>
	<u>Fiscal</u>	<u>Millions</u>	<u>Millions</u>	<u>Millions</u>	<u>Millions</u>	<u>Millions</u>
Actual	2000	0.000000	0.000000	0.162218	0.000000	-0.002664
Actual	2001	0.000000	0.000000	0.196256	0.000000	-0.002482
Actual	2002	0.000000	0.000000	0.199373	0.000000	-0.002548
Actual	2003	0.000000	0.000000	0.202971	0.000000	-0.002988
Actual	2004	0.000000	0.000000	0.211848	0.000000	-0.002697
Actual	2005	0.000000	0.000000	0.200675	0.000000	-0.003758
Actual	2006	0.000000	0.000000	0.174578	0.000000	-0.003294
Actual	2007	0.000000	0.000000	0.192597	0.000000	-0.003793
Actual	2008	0.000000	0.000000	0.198956	0.000000	-0.004214
Forecast	2009	0.000000	0.000000	0.193145	0.000000	-0.004341
Forecast	2010	0.000000	0.000000	0.195121	0.000000	-0.004412
Forecast	2011	0.000000	0.000000	0.202193	0.000000	-0.004486

Total Rev. = Grazing + Agriculture + O&G Lease + O&G Bonus + O&G Penalty + Misc. +
 Int. Land + Int. Stip + Int. Trust + Timber + Res. Dev.

Legislative Fiscal Division

Revenue Estimate Profile

Deaf and Blind Trust Interest and Income

Revenue Projection:

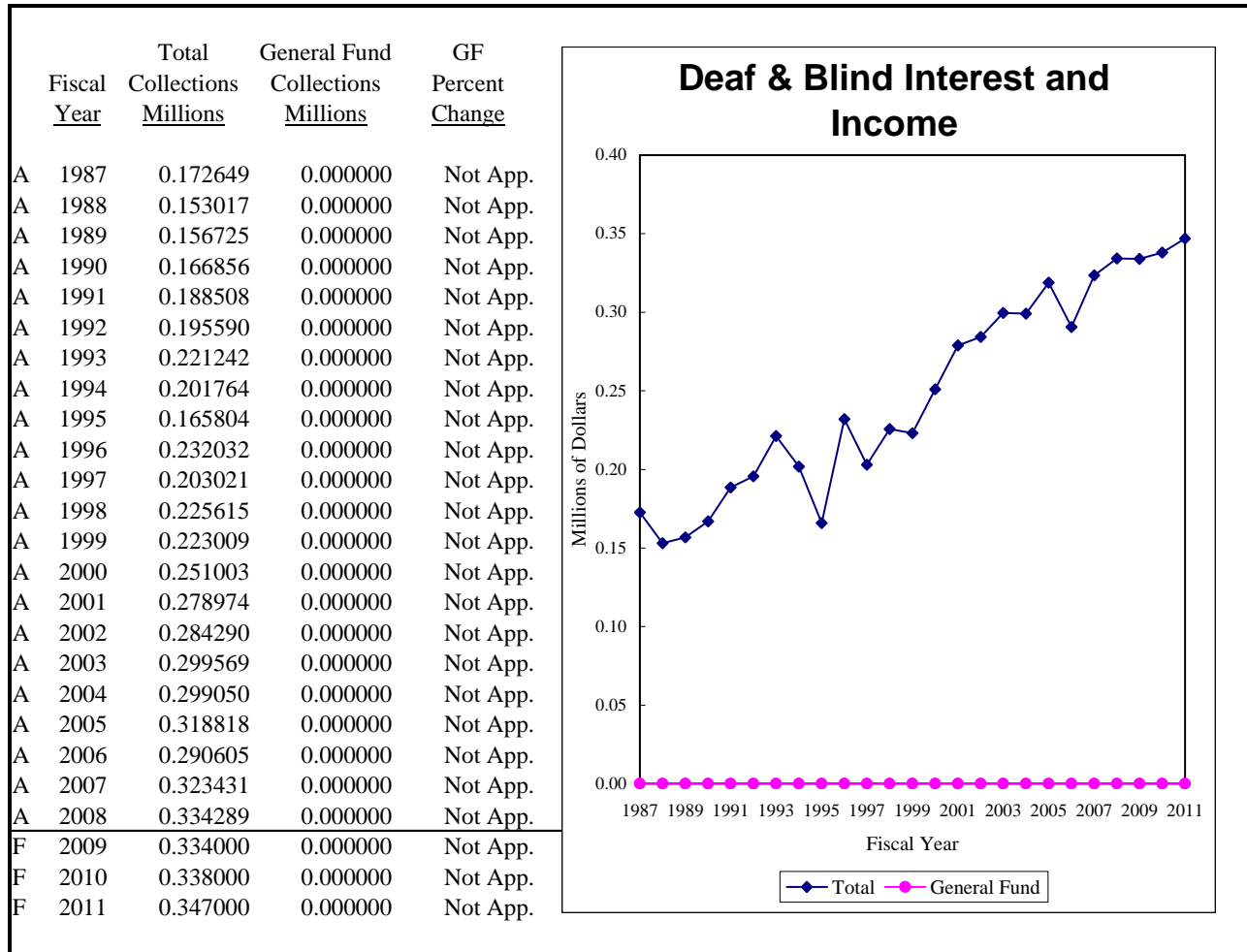

Data Source(s): Board of Investments, SABHRS, *Wall Street Journal*, Global Insight, Department of Natural Resources and Conservation

Contacts: Department of Natural Resources and Conservation

Legislative Fiscal Division

Revenue Estimate Profile

Economic Development Trust Interest

Revenue Description: Article IX, Section 5 of the Montana Constitution requires that 50.0 percent of all coal severance tax revenue be deposited in a permanent coal trust fund and that the principal of the trust "shall forever remain inviolate unless appropriated by a three-fourths vote of each house". Coal severance tax funds flowing into the trust fund are first used to secure and subsidize state bonds issued to finance water resource and renewable resource development projects and activities. With the enactment of House Bill 249 by the 2005 legislature, beginning fiscal 2006 the remaining funds are then split 50 percent (25 percent of total revenue) to the treasure state endowment trust fund, 25 percent (12.5 percent of total revenue) to the treasure state endowment regional water system trust fund, and 25 percent (12.5 percent of total revenue) to the big sky economic development trust fund. The permanent trust fund no longer receives coal severance tax revenue.

As of October 1, 1995, all fixed-income investments held by the state's major trust funds were transferred to a newly-created trust funds bond pool (TFBP). The majority of permanent coal tax trust funds are invested as part of the TFBP. Some funds, however, are invested on a short-term basis in the state's short-term investment pool (STIP). In addition, state law provides that trust funds may be used for in-state commercial loans to stimulate economic development.

Statutory Reference:

Tax Rate – NA
Distribution (MCA) – 17-5-703 (5b); use of earnings (90-1-205)
Date Due (MCA) – monthly (17-5-703(5b))

Applicable Tax Rate(s): N/A

Distribution: Interest earnings are deposited to a state special revenue fund and are statutorily appropriated to the Department of Commerce to pay administrative expenses with the remainder for:

1. 75% to local governments to be used for job creation; and
2. 25% to certified regional development corporations and economic development organizations

Legislative Fiscal Division

Revenue Estimate Profile

Economic Development Trust Interest

Distribution Chart:

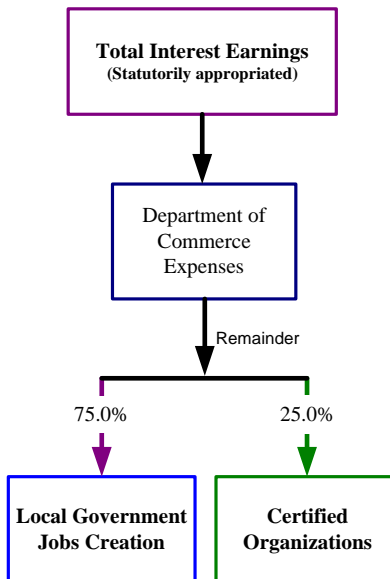

Collection Frequency: Monthly

% of Total General Fund Revenue: N/A

- Economic Factors
 - Prevailing national interest and bond rates
 - Inflationary pressures
 - Coal price
 - Coal production costs
- Social Factors - None
- Legislative Factors
 - State legislative impacts
 - Coal severance tax and distribution related changes
 - Constitutional restrictions on types of investments (i.e. no investments in equities)
 - Appropriations from the trust sub-fund
 - Federal legislative impacts

Revenue Estimate Methodology:

Data

The data used to estimate interest earnings from the big sky economic trust are obtained from the Board of Investments (BOI), Global Insight, and the state accounting system (SABHRS). The BOI provides information on historic interest rates as well as the gains and losses from the sale of securities. Projections of future interest rates are provided by Global Insight and historic interest collections are obtained from SABHRS.

Analysis

The economic trust was created from distributions of the coal severance tax. The economic trust was formed in fiscal 2006 as a sub-trust to the permanent coal trust. The Constitution requires that 50 percent of the coal severance tax collections be distributed to the coal trust, and 25 percent of that distribution (after the water bond debt service obligation is met) or 12.5 percent of total coal severance tax revenues is distributed to the Big Sky Economic Development trust. The principal or corpus of the trust now stands at \$37.9 million. Estimates of future deposits to the trust are developed in the coal severance tax projection and are expected to be \$5.3 million in fiscal 2009, \$5.7 million in fiscal 2010, and \$6.0 million in fiscal 2011.

Legislative Fiscal Division

Revenue Estimate Profile

Economic Development Trust Interest

To forecast the economic trust interest earnings, each of three interest/income components are estimated independently and combined. The estimated interest/income components include:

- Trust funds bond pool (TFBP)
- Short-term investment pool (STIP)
- New trust deposits

The TFBP was formed in 1995 to manage the fixed investments held in the state's major trust funds. Each trust owns "shares" of the pool and interest earnings are paid to each trust on a per-share basis. TFBP earnings are the largest source of earnings for the trust, as shown in the figure below. To estimate TFBP earnings, the base year (fiscal 2008) rate of return generated by the pool, as reported by the BOI, is adjusted during the forecast period for maturing securities. The applicable new long-term rate for these securities is based on an average of four long-term rates projected by Global Insight. The fiscal year average long-term interest rate is expected to be 5.5 percent in fiscal years 2009 and 2010 and 5.7 percent in fiscal year 2011.

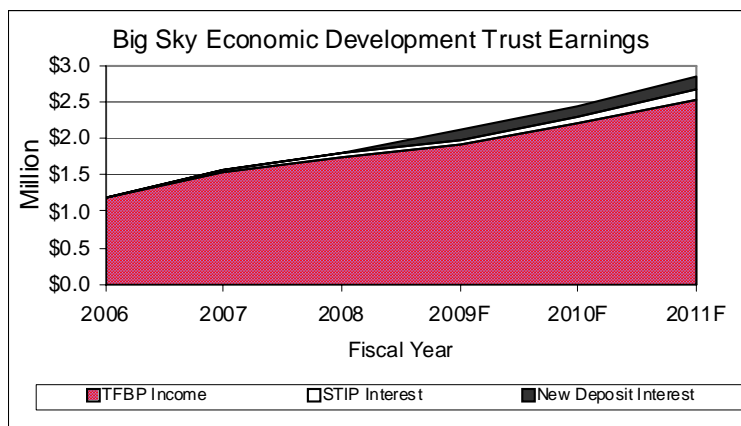

STIP interest (including other interest) is earned on cash, prior to investment in long-term investments. Funds are acquired from new deposits and/or maturing securities in the forecast period. Funds are held in STIP until the BOI determines that conditions are favorable for investment in the TFBP. To estimate future STIP earnings, an average short-term interest rate is developed, based on Global Insight projections of three short-term investments. The average of these rates is then converted to a fiscal year basis. The average fiscal year short-term interest rate is expected to be 1.5 percent in fiscal year 2009, 1.7 percent in fiscal year 2010, and 3.2 percent in fiscal year 2011.

Coal severance tax distributions to the trust are considered new deposits. New deposits are transferred to the trust on a quarterly basis. When the BOI receives the coal tax transfer, the funds are immediately invested in STIP. Funds are expected to remain in STIP for one month before being invested in the TFBP. The interest earned on new deposits is estimated by summing STIP earnings for one month with TFBP earnings for the remainder of the year.

Legislative Fiscal Division

Revenue Estimate Profile

Economic Development Trust Interest

Forecast Methodology:

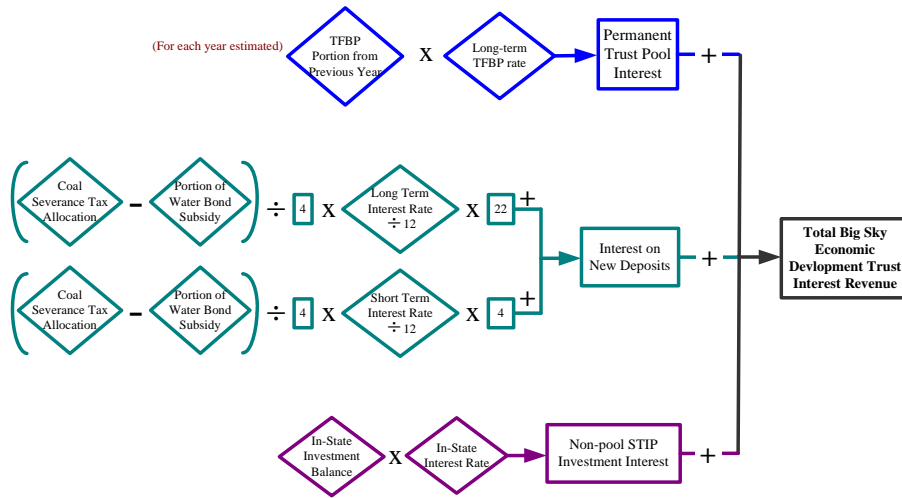

Revenue Estimate Assumptions:

	t	Total Rev.	GF Rev.	TFBP	STIP	Loan	Invested	Average
	Fiscal	Millions	Millions	Interest	Interest	Interest	Balance	Return
				Millions	Millions	Millions	Millions	Rate
Actual	2000	0.000000	0.000000					
Actual	2001	0.000000	0.000000					
Actual	2002	0.000000	0.000000	0.000000	0.000000	0.000000	0.000000	0.000000
Actual	2003	0.000000	0.000000	0.000000	0.000000	0.000000	0.000000	0.000000
Actual	2004	0.000000	0.000000	0.000000	0.000000	0.000000	0.000000	0.000000
Actual	2005	0.000000	0.000000	0.000000	0.000000	0.000000	0.000000	0.000000
Actual	2006	1.193690	0.000000	1.174442	0.019250	0.000000	23.608298	0.050562
Actual	2007	1.559210	0.000000	1.526434	0.032775	0.000000	29.122282	0.053540
Actual	2008	1.801342	0.000000	1.738420	0.062922	0.000000	37.683830	0.047801
Forecast	2009	2.117000	0.000000	1.921031	0.196112	0.000000	48.682314	0.043489
Forecast	2010	2.431000	0.000000	2.213758	0.217132	0.000000	54.423314	0.044666
Forecast	2011	2.830000	0.000000	2.528250	0.301616	0.000000	60.387314	0.046862

	t	Net Coal Tax	New Deposit	Non Pool	Non Pool
	Fiscal	New Deposit	Long Term	STIP	STIP Bal
		Millions	Rate	Rate	Millions
Actual	2000	0.000000	6.3380%	5.4290%	0.000000
Actual	2001	0.000000	6.8850%	4.7390%	0.000000
Actual	2002	0.000000	6.3380%	2.5650%	0.000000
Actual	2003	0.000000	5.7290%	1.3600%	0.000000
Actual	2004	0.000000	5.3650%	1.2650%	0.000000
Actual	2005	0.000000	5.1940%	2.3870%	0.000000
Actual	2006	4.477691	5.2340%	4.0770%	0.608562
Actual	2007	5.094842	5.4050%	4.7290%	0.272955
Actual	2008	5.666484	5.3790%	3.1940%	3.214739
Forecast	2009	5.332000	5.4900%	1.4970%	3.214739
Forecast	2010	5.741000	5.4780%	1.6830%	3.214739
Forecast	2011	5.964000	5.7480%	3.2000%	3.214739

Total Rev. = Invested Balance * Average Return

Legislative Fiscal Division

Revenue Estimate Profile

Economic Development Trust Interest

Revenue Projection:

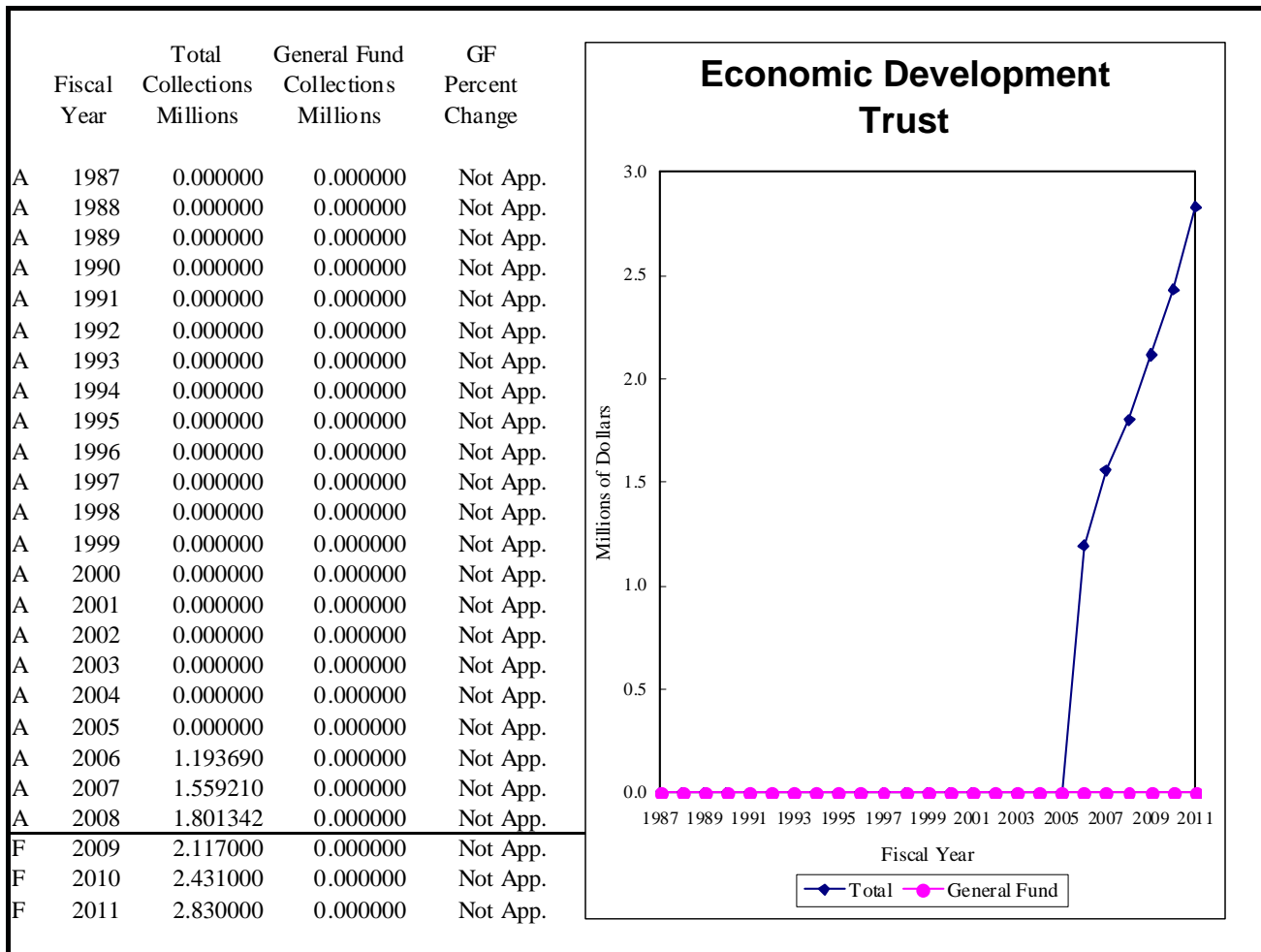

Data Source(s): Board of Investments, SABHRS, *Wall Street Journal*, Global Insight, Department of Natural Resources and Conservation

Contacts: Department of Natural Resources and Conservation

Legislative Fiscal Division

Revenue Estimate Profile

Parks Trust Interest

Revenue Description: Beginning in fiscal 1976, a portion of coal severance tax revenue was deposited into the Parks Acquisition and Arts Protection trust fund. The 1991 legislature split the principal of this trust into two separate trusts, the Parks Acquisition trust (parks trust) and the Arts Protection trust (cultural trust), with coal severance taxes allocated to each one. Except for fiscal 2003, the amount of 1.27 percent of coal tax revenues is statutorily allocated to the parks trust for the purpose of parks acquisition or management. The August 2002 special legislative session eliminated the allocation for fiscal 2003 only. Income from the parks trust must be appropriated for the acquisition, development, operation, and maintenance of state parks, state recreational areas, state monuments, and state historical sites under control of the Department of Fish, Wildlife and Parks.

Statutory Reference:

Tax Rate – NA
Distribution (MCA) – 15-35-108(4)
Date Due – NA

Applicable Tax Rate(s): N/A

Distribution: Interest earnings on the parks trust are allocated to the Department of Fish, Wildlife, and Parks and deposited to a state special revenue fund.

Distribution Chart:

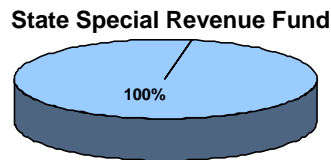

Collection Frequency: Monthly

% of Total General Fund Revenue: N/A

Revenue Estimate Methodology:

Data

The data used to estimate interest earnings from the parks trust are obtained from the Board of Investments (BOI), Global Insight, and the state accounting system (SABHRS). The BOI provides information on historic interest rates as well as the gains and losses from the sale of securities. Projections of future interest rates are provided by Global Insight and historic interest collections are obtained from SABHRS.

Analysis

The parks trust, formed in the late 1970's, was created from distributions of the coal severance tax. The parks trust receives coal tax distributions at the rate of 1.27 percent of the total tax. In one year of budget stress, the coal tax distribution to the parks trust was temporarily eliminated. The principal or corpus of the parks trust now stands at \$18.7 million, as demonstrated by the line in the figure below. Estimates of future deposits to the parks trust are developed in the coal severance tax projection and are expected to be \$562,000 in fiscal 2009, \$585,000 in fiscal 2010, and \$613,000 in fiscal 2011.

To forecast the parks trust interest earnings, each of three interest/income components are estimated independently and combined. The estimated interest/income components include:

- Trust funds bond pool (TFBP)
- Short-term investment pool (STIP)
- New trust deposits

Legislative Fiscal Division

Revenue Estimate Profile

Parks Trust Interest

The TFBP was formed in 1995 to manage the fixed investments held in the state’s major trust funds. Each trust owns “shares” of the pool and interest earnings are paid to each trust on a per-share basis. TFBP earnings are the largest source of earnings for the trust, as shown in the figure below. To estimate TFBP earnings, the base year (fiscal 2008) rate of return generated by the pool, as reported by the BOI, is adjusted during the forecast period for maturing securities. The applicable long-term rate for these securities is based on an average of four long-term rates projected by Global Insight. The fiscal year average long-term interest rate is expected to be 5.5 percent in fiscal years 2009 and 2010 and 5.7 in fiscal year 2011.

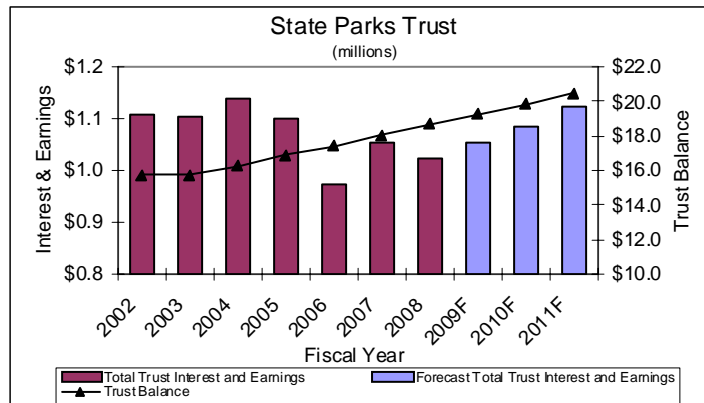

STIP interest (including other interest) is earned on cash, prior to investment in long-term investments. Funds are acquired from new deposits and/or maturing securities in the forecast period. Funds are held in STIP until the BOI determines that conditions are favorable for investment in the TFBP. To estimate future STIP earnings, an average short-term interest rate is developed, based on Global Insight projections of three short-term investments. The average of these rates is then converted to a fiscal year basis. The average fiscal year short-term interest rate is expected to be 1.5 percent in fiscal year 2009, 1.7 percent in fiscal year 2010, and 3.2 percent in fiscal year 2011.

The 1.27 percent coal severance tax distribution to the parks trust is considered new deposits. New deposits are transferred to the trust on a quarterly basis. When the BOI receives the coal tax transfer, the funds are immediately invested in STIP. Funds are expected to remain in STIP for one month before being invested in the TFBP. The interest earned on new deposits is estimated by summing STIP earnings for one month with TFBP earnings for the remainder of the year.

Legislative Fiscal Division

Revenue Estimate Profile

Parks Trust Interest

Forecast Methodology:

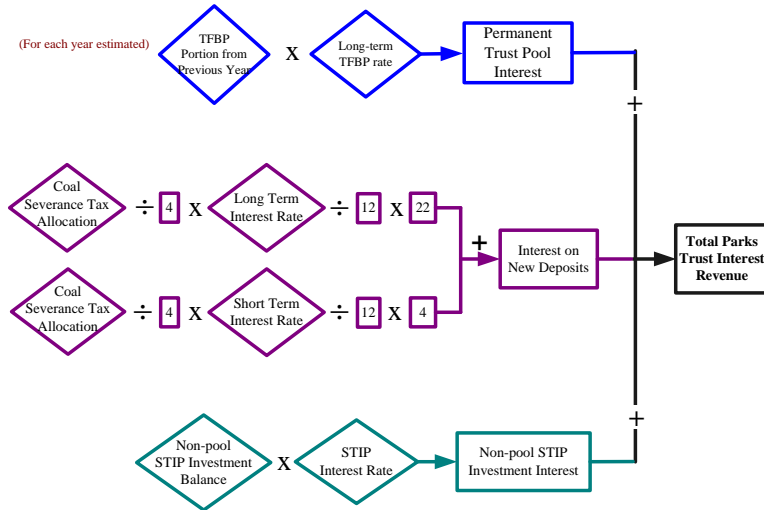

Revenue Estimate Assumptions:

t	Total Rev.	GF Rev.	TFBP	STIP	Invested	Average	
Fiscal	Millions	Millions	Interest	Interest	Balance	Return	
			Millions	Millions	Millions	Rate	
Actual	2000	1.050621	0.000000				
Actual	2001	1.083002	0.000000				
Actual	2002	1.105962	0.000000	1.100417	0.005545		
Actual	2003	1.115050	0.000000	1.101342	0.002596		
Actual	2004	1.140447	0.000000	1.138429	0.002019	16.189248	0.070445
Actual	2005	1.100104	0.000000	1.095405	0.004699	16.772286	0.065591
Actual	2006	0.971827	0.000000	0.957207	0.014619	17.305023	0.056159
Actual	2007	1.055431	0.000000	1.034061	0.021370	17.949575	0.058800
Actual	2008	1.024699	0.000000	1.007553	0.017147	18.568502	0.055185
Forecast	2009	1.053000	0.000000	1.035637	0.017129	19.706217	0.053423
Forecast	2010	1.085000	0.000000	1.066491	0.018193	20.291217	0.053456
Forecast	2011	1.122000	0.000000	1.098537	0.023101	20.904217	0.053656

t	Net Coal Tax	New Deposit	Non Pool	Non Pool	
Fiscal	New Deposit	Long Term	STIP	STIP Bal	
	Millions	Rate	Rate	Millions	
Actual	2000	0.450466	6.3380%	5.4290%	0.301775
Actual	2001	0.410682	6.8850%	4.7390%	0.177151
Actual	2002	0.401498	6.3380%	2.5650%	0.308519
Actual	2003	0.000000	5.7290%	1.3600%	0.140270
Actual	2004	0.400617	5.3650%	1.2650%	0.328045
Actual	2005	0.477958	5.1940%	2.3870%	0.236285
Actual	2006	0.454933	5.2340%	4.0770%	0.469081
Actual	2007	0.517636	5.4050%	4.7290%	0.513863
Actual	2008	0.575715	5.3790%	3.1940%	0.132916
Forecast	2009	0.562000	5.4900%	1.4970%	0.132916
Forecast	2010	0.585000	5.4780%	1.6830%	0.132916
Forecast	2011	0.613000	5.7480%	3.2000%	0.132916

Total Rev. = Invested Balance * Average Return

Legislative Fiscal Division

Revenue Estimate Profile

Parks Trust Interest

Revenue Projection:

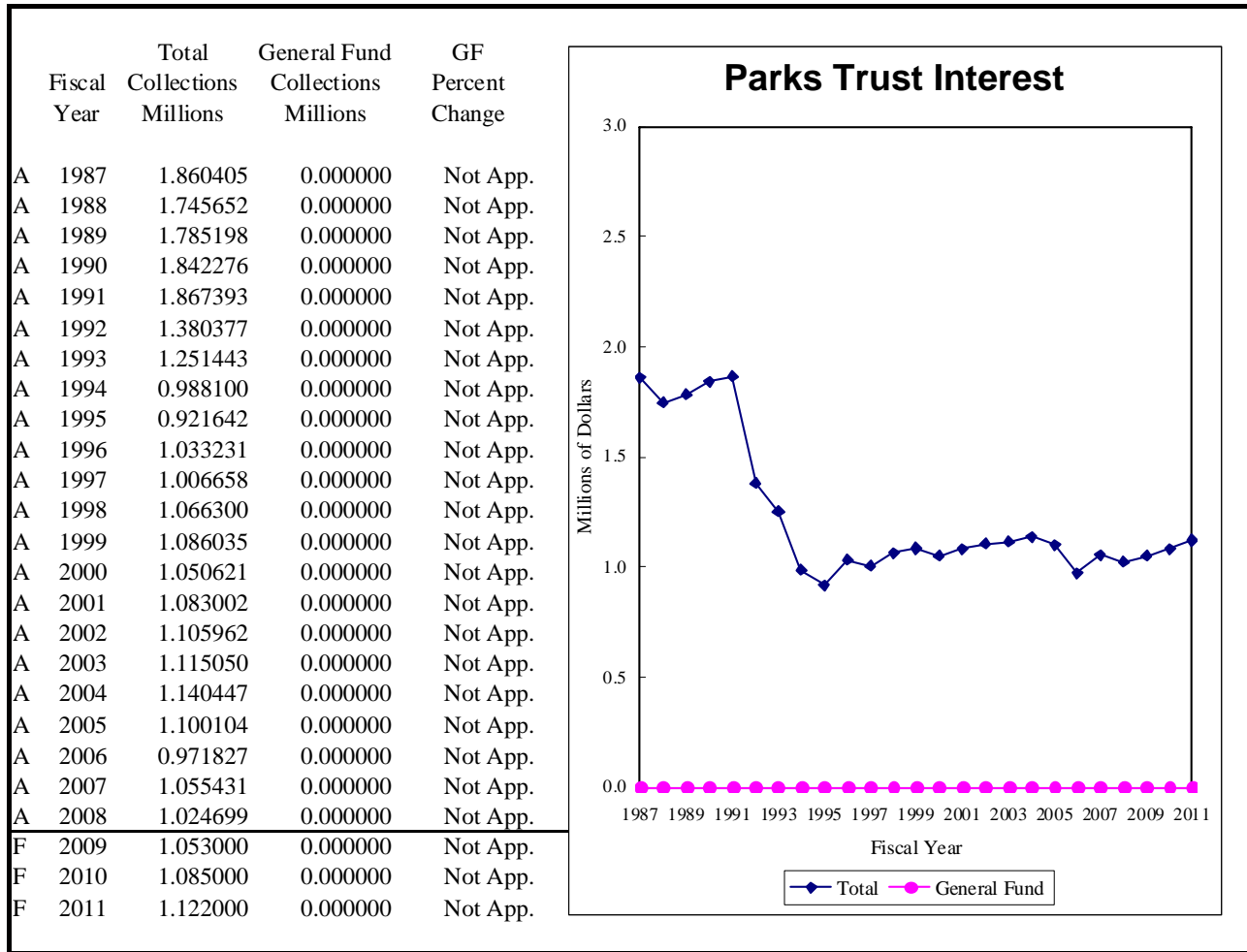

Data Source(s): Board of Investments, SABHRS, *Wall Street Journal*, Global Insight

Contacts:

Legislative Fiscal Division

Revenue Estimate Profile

Pine Hills Interest and Income

Revenue Description: Lands granted by the federal government to the state for the benefit of public schools and various state institutions generate income. These lands produce revenue through rents or crop shares for agricultural purposes, royalties from the sale of mineral rights, and sales of timber. Income from certain portions of public school/institution lands has been designated for the support of the Pine Hills youth correctional facility. Thus, some of these funds are deposited into a component of the trust and legacy trust fund referred to as the Pine Hills trust, which generates interest earnings for the state. As of October 1, 1995, all fixed-income investments held by the state's major trust funds were transferred to a newly-created Trust Funds Bond Pool (TFBP). The majority of trust and legacy trust funds are invested as part of the TFBP. Some funds, however, are invested on a short-term basis in the state's Short Term Investment Pool (STIP). The state constitution prohibits the investment of the permanent trust in common stock.

In accordance with statute, 3.0 percent of Pine Hills interest and income is diverted to the Department of Natural Resources and Conservation (DNRC) to be used for resource development purposes. Senate Bill 48, passed by the 1999 legislature, provides for the diversion of the following funds for the purpose of funding the Trust Land Management Division in the DNRC: 1) mineral royalties; 2) revenues from the sale of easements; and 3) 5.0 percent of interest and income previously credited to the common school trust. In addition, a portion of timber sale revenue is diverted to fund a portion of DNRC's timber program. The amount of the money diverted from the Pine Hills trust reduces the growth of the trust fund balance and, hence, reduces the amount of distributable interest earnings.

Statute:

Tax Rate – NA
Distribution (MCA) – 17-3-1003
Enabling Act, Sections 11 & 17
Other (MCA) – DNRC trust land administration diversion (77-1-109)
DNRC timber sale program diversion (77-1-613)
DNRC land bank administration diversion (77-2-362)
DNRC resource development diversion (77-1-607)
DNRC commercial lease diversion (77-1-905)

Applicable Tax Rate(s): N/A

Distribution: Interest and income from the trust, net of amounts to fund DNRC administration, is allocated to the Department of Corrections for support of the Pine Hills youth correctional facility.

Distribution Chart:

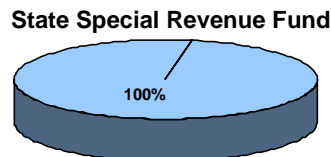

Collection Frequency: Monthly

% of Total General Fund Revenue: N/A

Revenue Estimate Methodology:

The estimate for interest and income from the Pine Hills trust is conducted with the goal of deriving the net amount of revenue that will be distributed to the trust beneficiary. This means that in addition to estimating the various distributable revenues from the capital land grant trust, estimates of the various diversions that reduce the amount of distributable revenue must also be estimated. Therefore, the estimated amounts shown for this revenue source are not total revenues, but are net of diversions.

Legislative Fiscal Division

Revenue Estimate Profile

Pine Hills Interest and Income

Permanent revenue (revenue that is not distributed, but remains in the trust such as from timber and mineral royalties), is estimated as part of the entire Trust and Legacy account (T & L) and earnings are portioned to this trust according to the number of shares owned.

Data

Data from SABHRS provide a history of each individual interest and income revenue component from which estimates can be made. Department of Natural Resources and Conservation (DNRC) annual reports provide additional information such as mineral prices and production and timber estimates. Budget submissions on the state budgeting system (MBARS) provide anticipated amount of diversions.

Analysis

The estimate is derived by first estimating the distributable revenue components and then estimating the amounts of the diversions.

Revenue Components

- Trust and Legacy Earnings (see the figure below) – The monetary assets of the trust are pooled with monetary assets of other land trusts in the T & L and invested by the Board of Investment in the trust funds bond pool. Based on the number of share each trust owns, a share of the earnings is deposited in each trust. For the Pine Hills trust, the actual FY 2008 share percentage of 0.77 is used. The estimation of the total pool earnings is a three stage process:
 - Earnings from new deposits – New deposits in the pool are estimated to be in \$1.6 million in FY 2009, \$8.5 million in FY 2010 and \$22.6 million in FY 2011. This additional money initially earns interest at the short-term rate (1.5 percent in FY 2009, 1.7 percent in FY 2010, and 3.2 percent in FY 2011) before it is invested in a longer term investment (5.5 percent in FY 2009, 5.5 percent in FY 2010, and 5.7 percent in FY 2011).
 - Earnings from existing balance – The pool balance in FY 2008 was \$439.2 million. The majority of these funds have been invested in bonds purchased over the past several year and average a return rate of 5.6 percent.
 - Non-portfolio earnings – Money not invested in the trust funds bond pool earns interest at the short-term rate of 1.7 in FY 2009, 2.0 percent in FY 2010, and 4.0 percent in FY 2011 on a balance of \$2.5 million, the actual balance from FY 2008.

Once the total amount of the pool earnings has been estimated by summing the above three items, the Pine Hills trust share of 0.77 percent is applied.

- Grazing Fees – Rates are tied to the price of cattle. Cattle prices are expected to be close to those experienced in FY 2008, perhaps slightly less. DNRC personnel anticipate the grazing fee revenue will be similar to FY 2008.

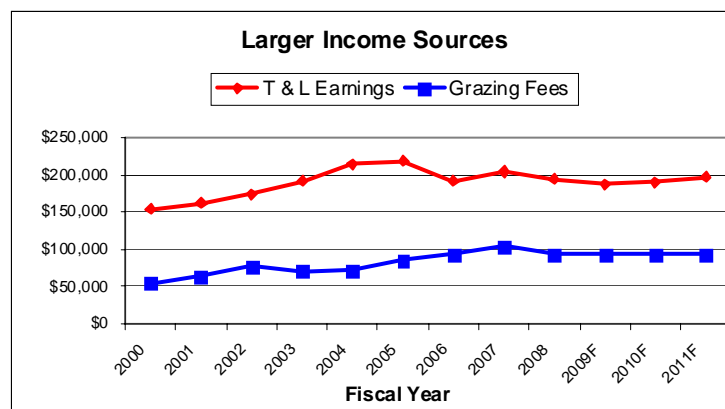

- Miscellaneous Rentals - These are small income components that are combined and estimated together. For each fiscal year estimated, the estimate is based on the growth rate between FY 2002 and FY 2008.
- Agricultural Fees – Fees are based on a crop share basis. Commodity prices are expected to be higher than FY 2008 resulting in greater returns. DNRC personnel anticipate that overall revenue will be about \$1.0 million more than FY

Legislative Fiscal Division

Revenue Estimate Profile

Pine Hills Interest and Income

2008 levels (see the figure below). Based on this information, revenues are increased in FY 2009 and remain constant through FY 2010 and FY 2011.

- Oil & Gas Leases – For each fiscal year estimated, the estimate is the average of the previous three years.
- Oil & Gas Bonuses & Penalties – No revenue was received in FY 2008. This is continued into the future.

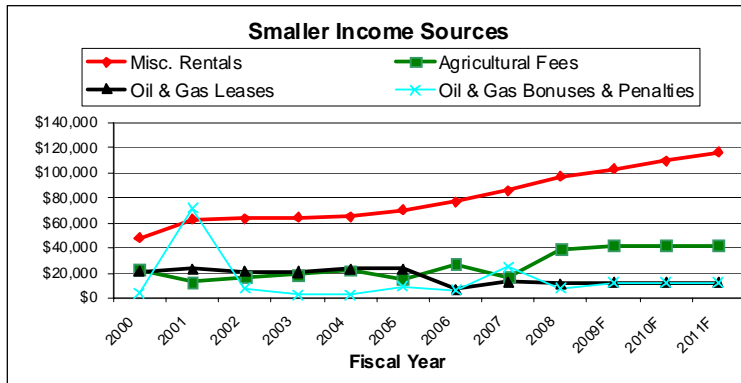

Diversions

Diversions fund operational costs in DNRC, but reduce the amount of revenue distributed to the trust beneficiaries (see the figure below). To determine future diversion amounts, DNRC’s present law budget amounts are used. The only diversion that affects distributable revenue is the three percent of all income from the trust that is diverted to an account to fund resource development on the trust lands.

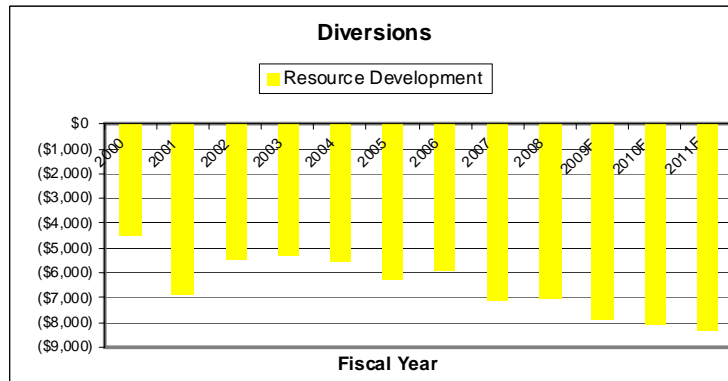

Adjustments and Distribution

Once total revenue and total diversions have been estimated, the net amounts are distributed 100 percent to the state special revenue fund.

Legislative Fiscal Division

Revenue Estimate Profile

Pine Hills Interest and Income

Forecast Methodology:

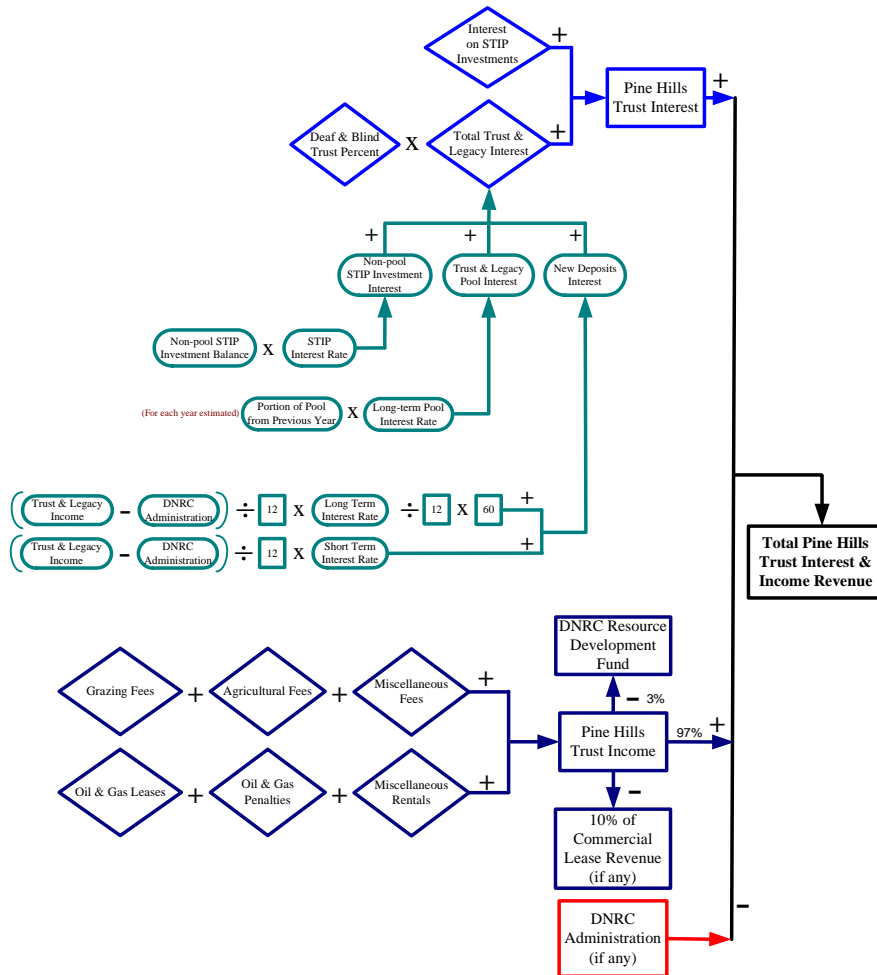

Legislative Fiscal Division

Revenue Estimate Profile

Pine Hills Interest and Income

Revenue Estimate Assumptions:

	t	Total Rev.	GF Rev.	TFBP	STIP	Pine
	<u>Fiscal</u>	<u>Millions</u>	<u>Millions</u>	<u>Interest</u>	<u>Interest</u>	<u>Hills Share</u>
				<u>Millions</u>	<u>Millions</u>	<u>T&L</u>
Actual	2000	0.304760	0.000000			0.006048
Actual	2001	0.390483	0.000000			0.006167
Actual	2002	0.355497	0.000000	29.627056	0.102664	0.005835
Actual	2003	0.364450	0.000000	29.146744	0.068370	0.006580
Actual	2004	0.394224	0.000000	30.087011	0.053502	0.007114
Actual	2005	0.415343	0.000000	28.106281	0.269698	0.007685
Actual	2006	0.396937	0.000000	24.428206	0.408162	0.007729
Actual	2007	0.442814	0.000000	26.206838	0.267652	0.007726
Actual	2008	0.434822	0.000000	25.159580	0.128925	0.007661
Forecast	2009	0.443000	0.000000	24.474900	0.076364	0.007661
Forecast	2010	0.451000	0.000000	24.552355	0.250056	0.007661
Forecast	2011	0.465000	0.000000	25.005341	0.696125	0.007661

	t	Trust Income	Trust Land	New Deposit	Non Pool	Non Pool
	<u>Fiscal</u>	<u>New Deposit</u>	<u>Admin.</u>	<u>Long Term</u>	<u>STIP</u>	<u>STIP Bal</u>
		<u>Millions</u>	<u>Millions</u>	<u>Rate</u>	<u>Rate</u>	<u>Millions</u>
Actual	2000	10.969295		7.0160%	5.4290%	11.676486
Actual	2001	12.667780	0.000000	6.8850%	4.7390%	6.984553
Actual	2002	2.348339	0.000000	6.3380%	2.5650%	7.334239
Actual	2003	2.363355	0.000000	5.7290%	1.3600%	6.242273
Actual	2004	2.971526	0.000000	5.3650%	1.2650%	7.049634
Actual	2005	1.457756	0.000000	5.1940%	2.3870%	12.106697
Actual	2006	1.425106	0.000000	5.2340%	4.0770%	3.862666
Actual	2007	7.173844	0.000000	5.4050%	4.7290%	14.953757
Actual	2008	3.101654	0.000000	5.3790%	3.1940%	2.461097
Forecast	2009	1.410837	0.000000	5.4900%	1.4970%	2.461097
Forecast	2010	8.269190	0.000000	5.4780%	1.6830%	2.461097
Forecast	2011	22.455124	0.000000	5.7480%	3.2000%	2.461097

Legislative Fiscal Division

Revenue Estimate Profile

Pine Hills Interest and Income

	<u>t</u>	<u>Grazing</u>	<u>Agriculture</u>	<u>Misc.</u>	<u>O&G Lease</u>	<u>O&G Bonus</u>	<u>O&G Penalty</u>	<u>Misc.</u>
	<u>Fiscal</u>	<u>Millions</u>	<u>Millions</u>	<u>Millions</u>	<u>Millions</u>	<u>Millions</u>	<u>Millions</u>	<u>Millions</u>
Actual	2000	0.054682	0.022855	0.047965	0.021231	0.000000	0.003895	0.000000
Actual	2001	0.063912	0.013002	0.063100	0.023526	0.066599	0.005510	0.000000
Actual	2002	0.077707	0.016967	0.063512	0.021550	0.000000	0.007482	0.000000
Actual	2003	0.070606	0.019163	0.064658	0.020743	0.000000	0.002359	0.000000
Actual	2004	0.071968	0.022278	0.065266	0.023583	0.000000	0.002283	0.000000
Actual	2005	0.085325	0.014803	0.070596	0.023390	0.000590	0.008881	0.000000
Actual	2006	0.093321	0.027332	0.076718	0.006895	0.002960	0.003690	0.000000
Actual	2007	0.104635	0.016818	0.086005	0.013333	0.017263	0.007328	0.000000
Actual	2008	0.093089	0.038769	0.097085	0.011653	0.000000	0.007528	0.000000
Forecast	2009	0.093089	0.041926	0.103153	0.012493	0.000000	0.012493	0.000000
Forecast	2010	0.093089	0.041926	0.109600	0.012493	0.000000	0.012493	0.000000
Forecast	2011	0.093089	0.041926	0.116450	0.012493	0.000000	0.012493	0.000000

	<u>t</u>	<u>Int. Land</u>	<u>Int. STIP</u>	<u>Int. Trust</u>	<u>Timber</u>	<u>Res. Dev.</u>
	<u>Fiscal</u>	<u>Millions</u>	<u>Millions</u>	<u>Millions</u>	<u>Millions</u>	<u>Millions</u>
Actual	2000	0.000000	0.000086	0.154047	0.000000	-0.004521
Actual	2001	0.000000	0.000000	0.161698	0.000000	-0.006864
Actual	2002	0.000000	0.000000	0.173729	0.000000	-0.005450
Actual	2003	0.000000	0.000000	0.192247	0.000000	-0.005326
Actual	2004	0.000000	0.000000	0.214407	0.000000	-0.005561
Actual	2005	0.000000	0.000000	0.218058	0.000000	-0.006300
Actual	2006	0.000000	0.000000	0.191952	0.000000	-0.005931
Actual	2007	0.000000	0.000000	0.204540	0.000000	-0.007108
Actual	2008	0.000000	0.000000	0.193741	0.000000	-0.007043
Forecast	2009	0.000000	0.000000	0.188087	0.000000	-0.007895
Forecast	2010	0.000000	0.000000	0.190011	0.000000	-0.008088
Forecast	2011	0.000000	0.000000	0.196899	0.000000	-0.008294

Total Rev. = Grazing + Agriculture + O&G Lease + O&G Bonus + O&G Penalty + Misc. +
Int. Land + Int. Stip + Int. Trust + Timber + Res. Dev.

Legislative Fiscal Division

Revenue Estimate Profile

Pine Hills Interest and Income

Revenue Projection:

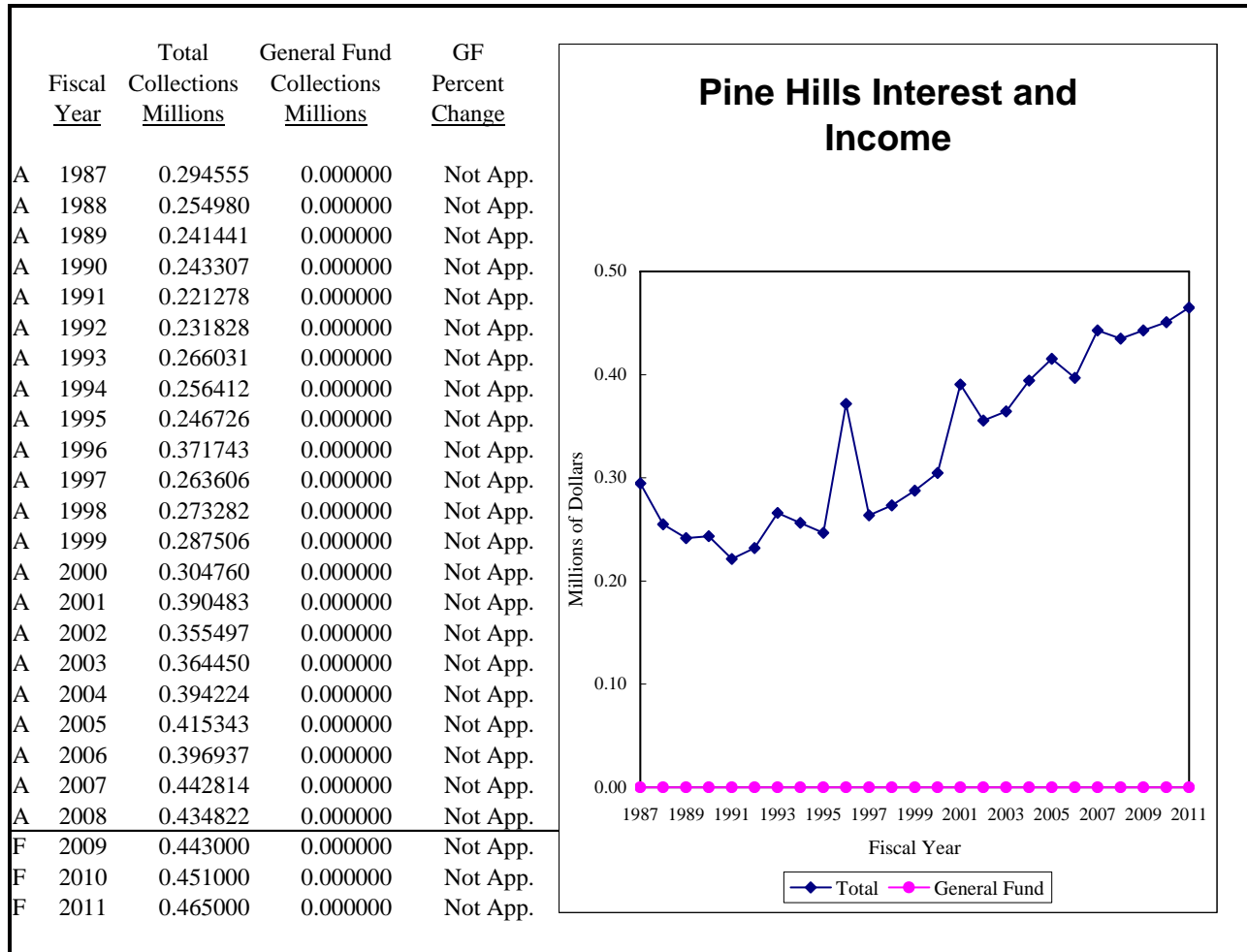

Data Source(s): Board of Investments, SABHRS, *Wall Street Journal*, Global Insight, Department of Natural Resources and Conservation

Contacts: Department of Natural Resources and Conservation

Legislative Fiscal Division

Revenue Estimate Profile

Regional Water Trust Interest

Revenue Description: The 1999 legislature (Senate Bill 220) created the Treasure State Endowment (TSE) Regional Water System Fund within the permanent coal tax trust fund. The fund receives 12.5 percent of total coal severance tax collections through June 2016. Interest earned on the fund is used to provide matching funds to plan and construct regional drinking water systems in Montana and fund state and local entity administrative expenses. Except for administrative expenses, each state dollar must be matched equally by local funds. The funds in the account are further restricted to finance regional drinking water systems from the waters of the Tiber reservoir and the Missouri River within specific geographic areas. The deposit of coal severance tax revenue to this fund terminates the end of fiscal 2016.

Statutory Reference:

Tax Rate – NA
Distribution (MCA) – 17-5-703 (4b); use of earnings (90-6-715)
Date Due (MCA) – monthly (17-5-703(4d))

Applicable Tax Rate(s): NA

Distribution: Interest earnings are deposited to a state special revenue fund and appropriated to the Department of Natural Resources and Conservation to fund eligible projects and pay administrative expenses.

Distribution Chart:

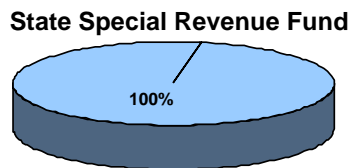

Collection Frequency: Monthly

% of Total General Fund Revenue: N/A

Revenue Estimate Methodology:

Data

The data used to estimate interest earnings from the regional water trust are obtained from the Board of Investments (BOI), Global Insight, and the state accounting system (SABHRS). The BOI provides information on historic interest rates as well as the gains and losses from the sale of securities. Projections of future interest rates are provided by Global Insight and historic interest collections are obtained from SABHRS.

Analysis

The regional water trust was created from distributions of the coal severance tax. The regional water trust was formed in 2000 as a sub-trust to the permanent coal trust. The Constitution requires that 50 percent of the coal severance tax collections be distributed to the coal trust, and 25 percent of that distribution (after the water bond debt service obligation is met) or 12.5 percent of total coal severance tax revenues is distributed to the regional water trust. The principal or corpus of the regional water trust now stands at \$44.0 million. Estimates of future deposits to the trust are developed in the coal severance tax projection and are expected to be \$5.3 million in fiscal 2009, \$5.7 million in fiscal 2010, and \$6.0 million in fiscal 2011.

Legislative Fiscal Division

Revenue Estimate Profile

Regional Water Trust Interest

To forecast the regional water trust interest earnings, each of three interest/income components are estimated independently and combined. The estimated interest/income components include:

- Trust fund bond pool (TFBP)
- Short-term investment pool (STIP)
- New trust deposits

The TFBP was formed in 1995 to manage the fixed investments held in the state's major trust funds. Each trust owns "shares" of the pool and interest earnings are paid to each trust on a per-share basis. TFBP earnings are the largest source of earnings for the trust, as shown in the figure below. To estimate TFBP earnings, the base year (fiscal 2008) rate of return generated by the pool, as reported by the BOI, is adjusted during the forecast period for maturing securities. The applicable long-term rate for these securities is based on an average of four long-term rates projected by Global Insight. The fiscal year average long-term interest rate is expected to be 5.5 percent in fiscal years 2009 and 2010 and 5.7 percent in fiscal year 2011.

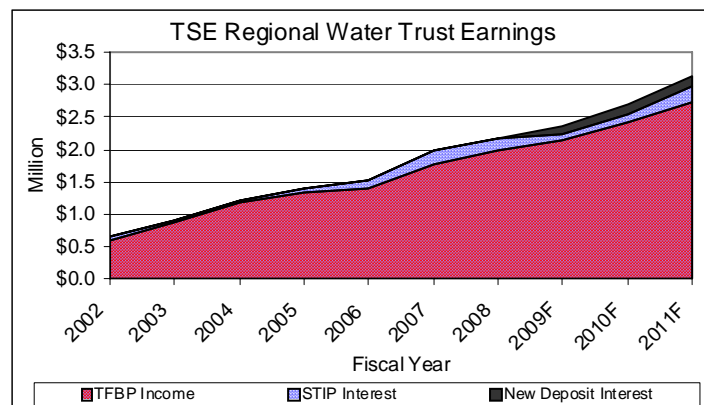

STIP interest (including other interest) is earned on cash, prior to investment in long-term investments. Funds are acquired from new deposits and/or maturing securities forecast period. Funds are held in STIP until the BOI determines that conditions are favorable for investment in the TFBP. To estimate future STIP earnings, an average short-term interest rate is developed, based on Global Insight projections of three short-term investments. The average of these rates is then converted to a fiscal year basis. The average fiscal year short-term interest rate is expected to be 1.5 percent in fiscal year 2009, 1.7 percent in fiscal year 2010, and 3.2 percent in fiscal year 2011.

Coal severance tax distributions to the regional water trust are considered new deposits. New deposits are transferred to the trust on a quarterly basis. When the BOI receives the coal tax transfer, the funds are immediately invested in STIP. Funds are expected to remain in STIP for one month before being invested in the TFBP. The interest earned on new deposits is estimated by summing STIP earnings for one month with TFBP earnings for the remainder of the year.

Legislative Fiscal Division

Revenue Estimate Profile

Regional Water Trust Interest

Forecast Methodology:

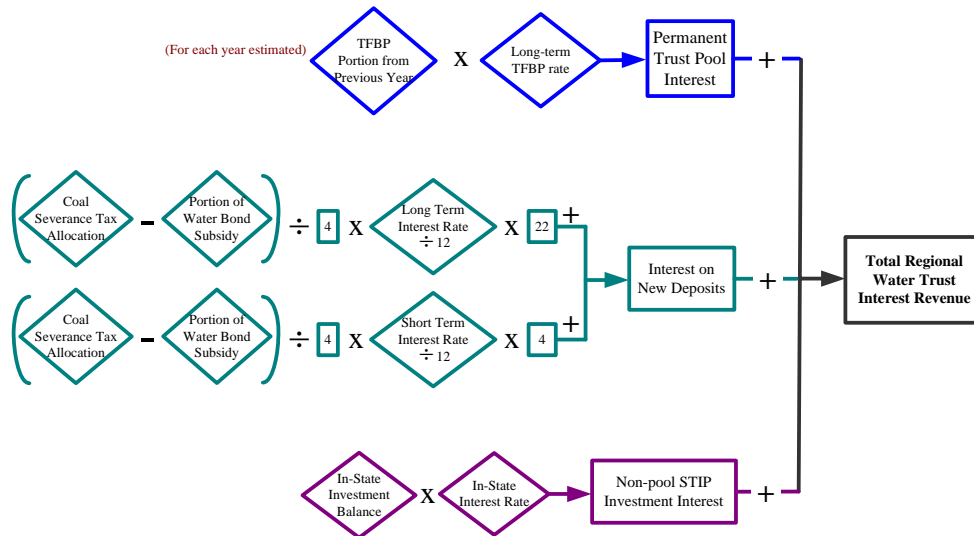

Revenue Estimate Assumptions:

t	Total Rev.	GF Rev.	TFBP	STIP	Loan	Invested	Average
Fiscal	Millions	Millions	Millions	Millions	Millions	Balance	Return
						Millions	Rate
Actual	2000	0.032058	0.000000				
Actual	2001	0.370163	0.000000				
Actual	2002	0.643133	0.000000	0.610527	0.032606	0.000000	
Actual	2003	0.894258	0.000000	0.864661	0.029598	0.000000	
Actual	2004	1.201061	0.000000	1.173660	0.027401	0.000000	20.942460
Actual	2005	1.396302	0.000000	1.340362	0.055941	0.000000	24.913396
Actual	2006	1.527443	0.000000	1.390830	0.136614	0.000000	30.573159
Actual	2007	1.978817	0.000000	1.772345	0.206472	0.000000	36.505390
Actual	2008	2.174930	0.000000	1.969567	0.205364	0.000000	43.857799
Forecast	2009	2.369000	0.000000	2.131575	0.237326	0.000000	54.856283
Forecast	2010	2.690000	0.000000	2.424302	0.265535	0.000000	60.597283
Forecast	2011	3.136000	0.000000	2.738794	0.397463	0.000000	66.561283

t	Net Coal Tax	New Deposit	Non Pool	Non Pool	
Fiscal	New Deposit	Long Term	STIP	STIP Bal	
	Millions	Rate	Rate	Millions	
Actual	2000	4.433724	6.3380%	5.4290%	3.441977
Actual	2001	4.042147	6.8850%	4.7390%	0.845223
Actual	2002	3.951756	6.3380%	2.5650%	1.578601
Actual	2003	3.677943	5.7290%	1.3600%	1.894047
Actual	2004	3.943085	5.3650%	1.2650%	2.693965
Actual	2005	4.704314	5.1940%	2.3870%	2.765447
Actual	2006	4.477691	5.2340%	4.0770%	3.825680
Actual	2007	5.094842	5.4050%	4.7290%	3.908386
Actual	2008	5.666484	5.3790%	3.1940%	5.610920
Forecast	2009	5.332000	5.4900%	1.4970%	5.610920
Forecast	2010	5.741000	5.4780%	1.6830%	5.610920
Forecast	2011	5.964000	5.7480%	3.2000%	5.610920

Total Rev. = Invested Balance * Average Return

Legislative Fiscal Division

Revenue Estimate Profile

Regional Water Trust Interest

Revenue Projection:

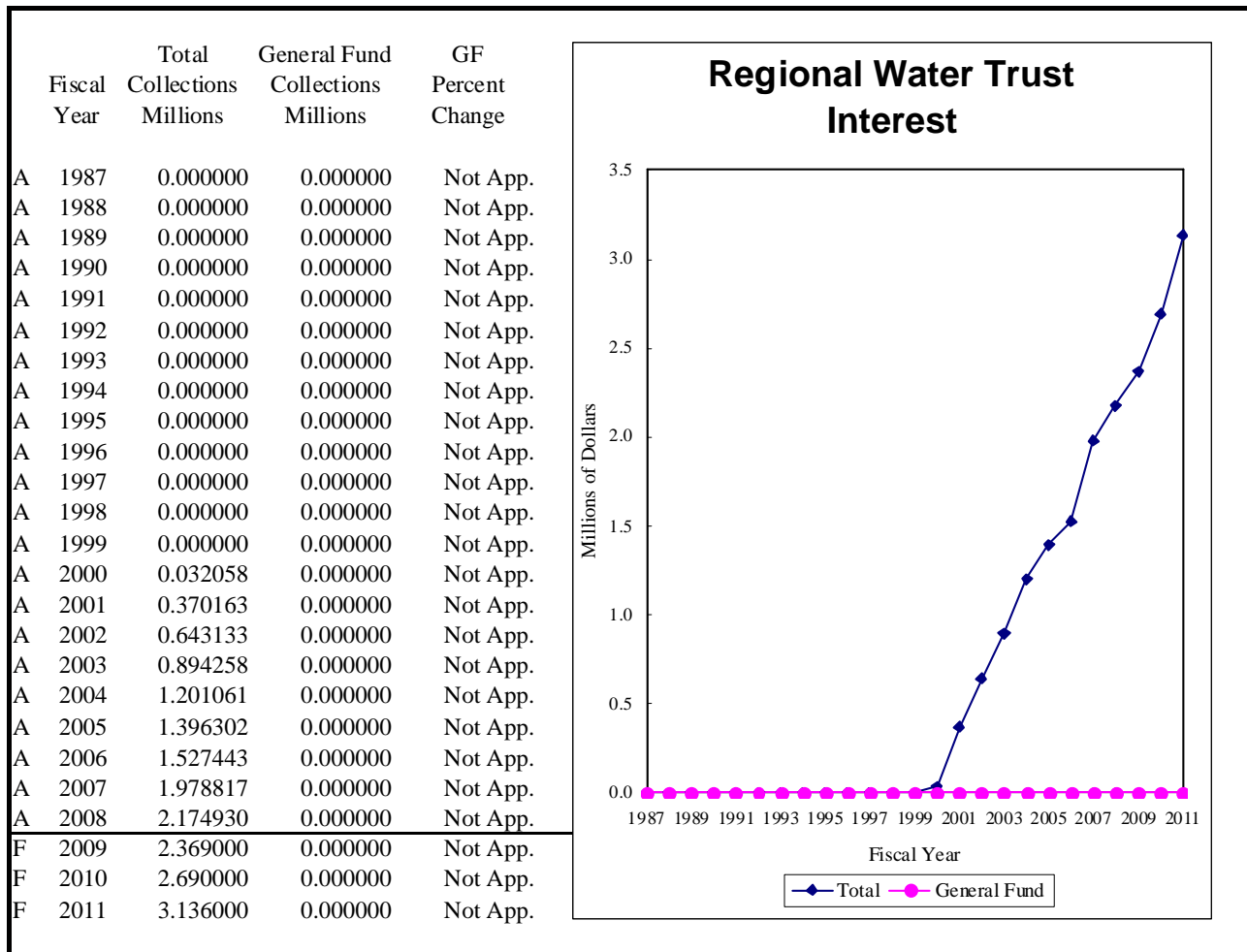

Data Source(s): Board of Investments, SABHRS, *Wall Street Journal*, Global Insight

Contacts:

Legislative Fiscal Division

Revenue Estimate Profile

Resource Indemnity Trust Interest

Revenue Description: Article IX, Section 2 of the Montana Constitution and Title 15, Chapter 38, MCA, requires that certain resource extraction taxes, as determined by the legislature, be placed in a trust. The principal of the Resource Indemnity Trust (RIT) "shall forever remain inviolate in an amount of one hundred million dollars (\$100,000,000), guaranteed by the state against loss or diversion." Once the principal of the trust reaches \$100.0 million, any additional tax deposits may be appropriated. Interest earnings on the RIT are to be spent to improve the total environment and rectify damage to the environment. It is also the legislature's intent that the use of interest earnings for operations of state government be minimized.

On July 1, 2002 the Governor by executive order certified to the Secretary of State that the RIT balance had reached \$100 million. In prior years, the RIT had received revenue from the resource indemnity and ground water assessment tax and the oil and gas tax. Because these allocations of revenue are no longer deposited to the trust, the trust balance will remain constant and interest earnings will be dependent only on the interest rates.

Statutory Reference:

Tax Rate – NA

Distribution (MCA) – Montana Constitution, Article IX, Section 2; 15-38-202(2), use of earnings (15-38-203)

Date Due – NA

Applicable Tax Rate(s): N/A

Distribution: Statute allocates RIT interest earnings in the following manner:

- 1) at the beginning of the biennium, an amount not to exceed \$50,000 to the oil and gas mitigation account to bring the balance up to \$200,000. Money in this account is statutorily appropriated to the Board of Oil and Gas Conservation for the cost of plugging wells that have been abandoned and for which no responsible party can be found;
- 2) at the beginning of the biennium, \$500,000 to the water storage state special revenue account to provide loans and grants for water storage projects;
- 3) \$3.5 million annually to the natural resources projects state special revenue account for distribution as grants;
- 4) \$300,000 annually to the ground water assessment account to improve ground water management and protection;
- 5) \$500,000 annually to the future fisheries program for bull trout and cutthroat trout recovery;
- 6) \$175,000 annually to the environmental contingency fund which is statutorily appropriated upon authorization of the Governor for unanticipated public needs arising from certain disasters and emergencies [and for natural resource restoration (valid only for the 2009 biennium)]; and
- 7) of the remaining RIT interest earnings: a) 65 percent to the natural resources operations state special revenue account for program and administrative costs; b) 26 percent to the hazardous waste/CERCLA state special revenue account for superfund activities; and c) 9.0 percent to the environmental quality protection state special revenue fund for additional clean-up activities.

The Department of Natural Resources and Conservation administers two of the RIT interest accounts which are used for grants, loans, and administrative costs: the renewable resource grant and loan program account and the reclamation and development grant account. These accounts also receive funding from other sources. All grants and loans made from these accounts require legislative approval. Grants must also be appropriated.

Legislative Fiscal Division

Revenue Estimate Profile

Resource Indemnity Trust Interest

Distribution Chart:

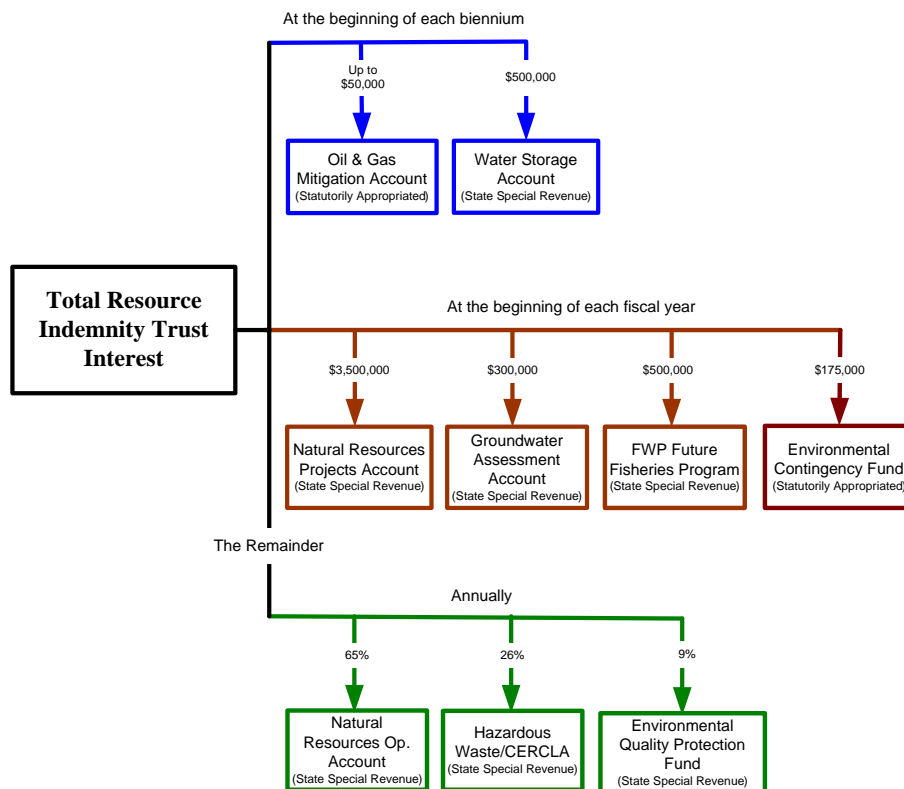

Collection Frequency: Monthly

% of Total General Fund Revenue: N/A

Revenue Estimate Methodology:

Data

The data used to estimate interest earnings from the resource indemnity (RIT) trust are obtained from the Board of Investments (BOI), Global Insight, and the state accounting system (SABHRS). The BOI provides information on historic interest rates as well as the gains and losses from the sale of securities. Projections of future interest rates are provided by Global Insight and historic interest collections are obtained from SABHRS.

Analysis

The RIT trust, formed in the mid 1970's, was created from distributions of the resource indemnity and ground water assessment tax (RIGWA) and the oil and gas tax. The resource indemnity trust reached its constitutionally required principal of \$100 million in fiscal 2002. As a result, the trust no longer receives new income from tax distributions. The principal or corpus of the resource indemnity trust now stands at \$100.0 million, as shown by the line in the figure below. No new deposits are anticipated for the trust.

To forecast the resource indemnity trust interest earnings, each of three interest/income components are estimated independently and combined. The estimated interest/income components include:

- Trust funds bond pool (TFBP)
- Short-term investment pool (STIP)
- New trust deposits (if anticipated)

Legislative Fiscal Division

Revenue Estimate Profile

Resource Indemnity Trust Interest

The TFBP was formed in 1995 to manage the fixed investments held in the state’s major trust funds. Each trust owns “shares” of the pool and interest earnings are paid to each trust on a per-share basis. TFBP earnings are the largest source of earnings for the trust, as shown in the figure below. To estimate TFBP earnings, the base year (fiscal 2008) rate of return generated by the pool, as reported by the BOI, is adjusted during the forecast period for maturing securities. The applicable long-term rate for these securities is based on a two-year average of four long-term rates projected by Global Insight. The fiscal year long-term rate is estimated to be 5.5 percent, 5.5 percent, and 5.7 percent for fiscal years 2009 through 2011, respectively. The applicable rates are multiplied by the trust balance to determine earnings.

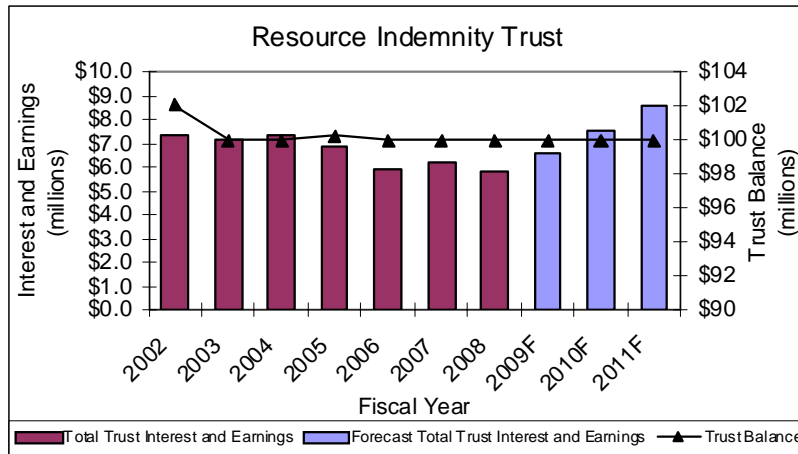

STIP interest (including other interest) is earned on cash, prior to investment in long-term investments. Funds are acquired from new deposits and/or maturing securities in the forecast period. Funds are held in STIP until the BOI determines that conditions are favorable for investment in the TFBP. To estimate future STIP earnings, an average short-term interest rate is developed, based on Global Insight projections of three short-term investments. The average of these rates is then converted to a fiscal year basis. Because no new deposits are anticipated for the trust, STIP earnings are projected for only non-pool balances estimated at the FY 2008 amount.

Legislative Fiscal Division

Revenue Estimate Profile

Resource Indemnity Trust Interest

Forecast Methodology:

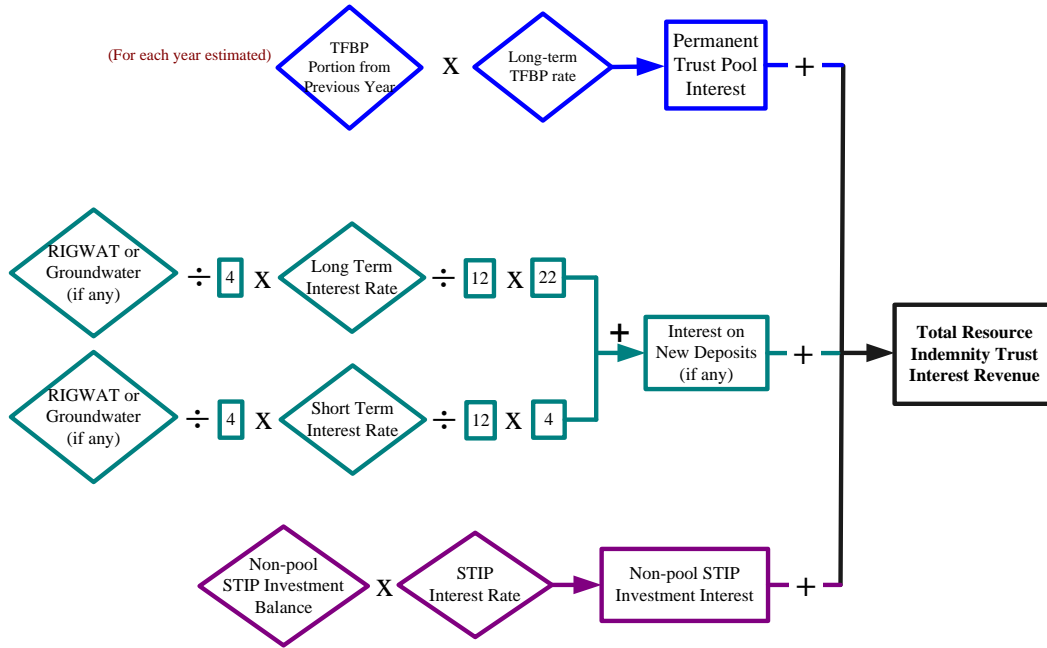

Legislative Fiscal Division

Revenue Estimate Profile

Resource Indemnity Trust Interest

Revenue Estimate Assumptions:

	<u>t</u>	<u>Total Rev.</u>	<u>GF Rev.</u>	<u>TFBP</u>	<u>STIP</u>	<u>Invested</u>	<u>Average</u>
	<u>Fiscal</u>	<u>Millions</u>	<u>Millions</u>	<u>Interest</u>	<u>Interest</u>	<u>Balance</u>	<u>Return</u>
				<u>Millions</u>	<u>Millions</u>	<u>Millions</u>	<u>Rate</u>
Actual	2000	9.184060	0.000000				
Actual	2001	7.305993	0.000000				
Actual	2002	7.320563	0.000000	7.286083	0.034480		
Actual	2003	7.174342	0.000000	7.161271	0.013072		
Actual	2004	7.380242	0.000000	7.375168	0.005073	100.644275	0.073330
Actual	2005	6.247097	0.000000	6.889636	0.012289	100.909672	0.068397
Actual	2006	5.915563	0.000000	5.896878	0.018684	100.506457	0.058858
Actual	2007	6.220240	0.000000	6.197611	0.022629	100.722508	0.061756
Actual	2008	5.800854	0.000000	5.785649	0.015204	100.503825	0.057718
Forecast	2009	5.582000	0.000000	5.573199	0.008666	100.503825	0.055539
Forecast	2010	5.584000	0.000000	5.573199	0.010178	100.503825	0.055554
Forecast	2011	5.594000	0.000000	5.573199	0.020154	100.503825	0.055653

	<u>t</u>	<u>Net Tax</u>	<u>New Deposit</u>	<u>Non Pool</u>	<u>Non Pool</u>
	<u>Fiscal</u>	<u>New Deposit</u>	<u>Long Term</u>	<u>STIP</u>	<u>STIP Bal</u>
		<u>Millions</u>	<u>Rate</u>	<u>Rate</u>	<u>Millions</u>
Actual	2000	3.391472	6.3380%	5.4290%	3.712675
Actual	2001	2.205880	6.8850%	4.7390%	1.557391
Actual	2002	1.588631	6.3380%	2.5650%	2.175871
Actual	2003	0.000000	5.7290%	1.3600%	0.740511
Actual	2004	-0.000188	5.3650%	1.2650%	0.644299
Actual	2005	0.252454	5.1940%	2.3870%	0.909696
Actual	2006	0.000000	5.2340%	4.0770%	0.506481
Actual	2007	0.000000	5.4050%	4.7290%	0.722532
Actual	2008	0.000000	5.3790%	3.1940%	0.503849
Forecast	2009	0.000000	5.4900%	1.4970%	0.503849
Forecast	2010	0.000000	5.4780%	1.6830%	0.503849
Forecast	2011	0.000000	5.7480%	3.2000%	0.503849

	<u>t</u>	<u>Hazardous</u>	<u>Environmental</u>	<u>Renewable</u>	<u>Reclamation</u>	<u>Environmental</u>
	<u>Fiscal</u>	<u>Waste</u>	<u>Quality</u>	<u>Resource</u>	<u>Development</u>	<u>Contingency</u>
		<u>Millions</u>	<u>Millions</u>	<u>Millions</u>	<u>Millions</u>	<u>Millions</u>
Actual	2000	0.941319	0.319852	3.721445	3.176444	0.175000
Actual	2001	0.796322	0.274126	3.259425	2.676120	0.000000
Actual	2002	0.534446	0.185001	3.356669	2.219447	0.175000
Actual	2003	0.678555	0.231326	3.026507	2.587954	0.000000
Actual	2004	0.564353	0.192393	2.894137	2.354359	0.175000
Actual	2005	0.474561	0.161782	2.790060	2.170694	0.000000
Actual	2006	0.169146	0.058551	2.435169	1.727697	0.175000
Actual	2007	0.436862	0.151222	2.744072	2.088084	0.000000
Actual	2008	0.201722	0.069827	0.000000	0.000000	0.175000
Forecast	2009	0.287820	0.099630	0.000000	0.000000	0.175000
Forecast	2010	0.145340	0.050310	0.000000	0.000000	0.175000
Forecast	2011	0.290940	0.100710	0.000000	0.000000	0.175000

Legislative Fiscal Division

Revenue Estimate Profile

Resource Indemnity Trust Interest

	t	Water Storage	Oil & Gas Receipts	FWP Receipts	Groundwater Receipts	NR Operation Receipts	NR Projects Receipts
	Fiscal	Millions	Millions	Millions	Millions	Millions	Millions
Actual	2000	0.500000	0.050000	0.000000	0.300000	0.000000	0.000000
Actual	2001	0.000000	0.000000	0.000000	0.300000	0.000000	0.000000
Actual	2002	0.500000	0.050000	0.000000	0.300000	0.000000	0.000000
Actual	2003	0.000000	0.000000	0.350000	0.300000	0.000000	0.000000
Actual	2004	0.500000	0.050000	0.350000	0.300000	0.000000	0.000000
Actual	2005	0.000000	0.000000	0.350000	0.300000	0.000000	0.000000
Actual	2006	0.500000	0.050000	0.500000	0.300000	0.000000	0.000000
Actual	2007	0.000000	0.000000	0.500000	0.300000	0.000000	0.000000
Actual	2008	0.500000	0.050000	0.500000	0.300000	0.504305	3.500000
Forecast	2009	0.000000	0.000000	0.500000	0.300000	0.719550	3.500000
Forecast	2010	0.500000	0.050000	0.500000	0.300000	0.363350	3.500000
Forecast	2011	0.000000	0.000000	0.500000	0.300000	0.727350	3.500000

Total Rev. = Invested Balance * Average Return

Revenue Projection:

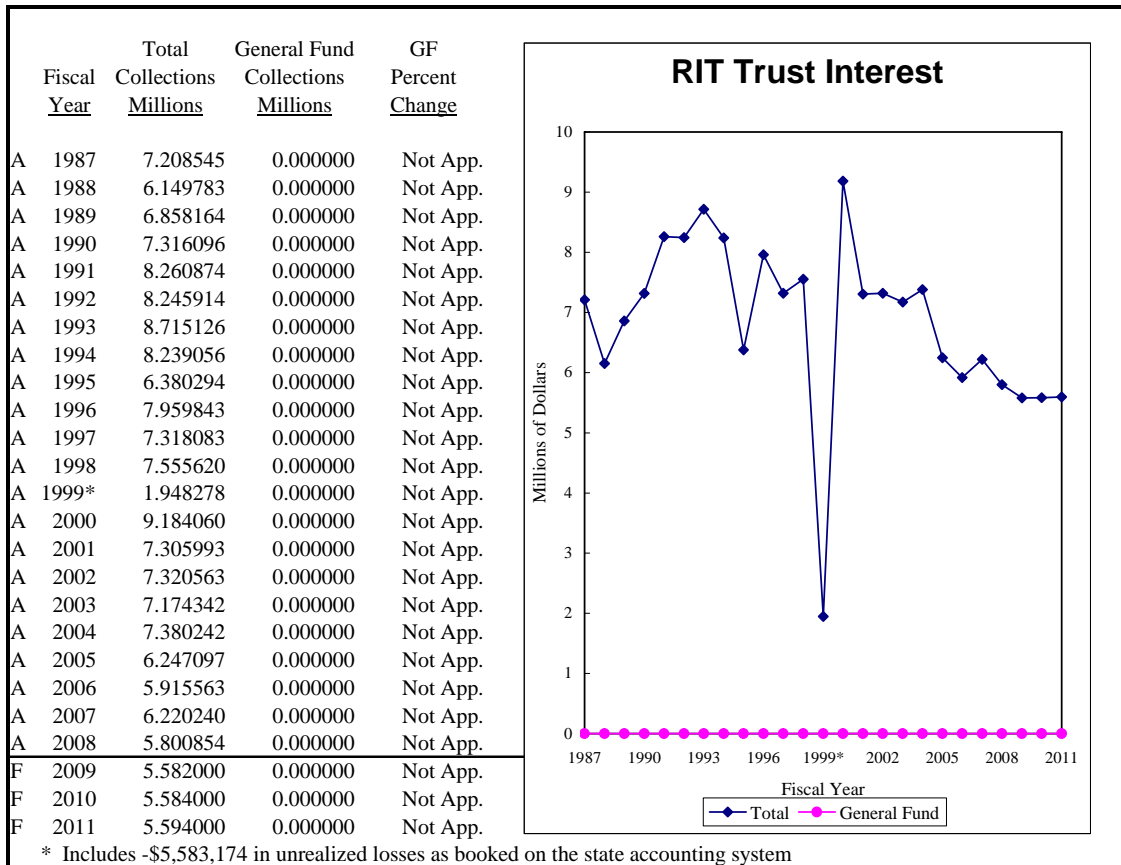

Data Source(s): Board of Investments, SABHRS, *Wall Street Journal*, Global Insight

Contacts:

Legislative Fiscal Division

Revenue Estimate Profile

Tobacco Trust Interest

Revenue Description: Due to passage of Montana Constitutional Amendment 35 by the electorate in November 2000, the legislature is required to dedicate not less than 40 percent of tobacco settlement money to a permanent trust fund. Initially, the legislature did not determine the exact percentage to be deposited to the trust fund, the revenue estimate assumes 40 percent. Since the passage of Initiative 146 by the electorate in November 2002, 32 percent of the tobacco settlement money is to fund tobacco prevention and 17 percent is to fund the Children's Health Insurance Program. As amended in SB 485 by the 2003 legislature, money from these allocations can also be used to fund human services programs and to match federal Medicaid funds through fiscal 2005. The remaining 11 percent of the money is deposited to the general fund. Interest earnings from the trust can only be used for tobacco disease prevention programs and programs providing benefits, services, or coverage that are related to the health care needs of Montanans. HB 743 enacted by the 2007 Legislature added chronic disease programs to the definition of tobacco disease prevention programs. The earnings cannot be used to replace state or federal money used to fund tobacco disease prevention programs and state programs that existed on December 31, 1999, providing benefits, services, or coverage of the health care needs of Montanans.

Statutory Reference:

Tax Rate – NA

Distribution (MCA) – Montana Constitution Article XII, Section 4; 17-6-601; 17-6-603

Date Due – Interest deposits are mostly made monthly, but none in July and two in June

Applicable Tax Rate(s): NA

Distribution: Interest earnings from the trust fund are distributed:

1. 90 percent to a state special revenue account for appropriation by the legislature for disease prevention programs (include chronic disease programs) and state programs providing benefits, services, or coverage that are related to the health care needs of the people of Montana; and
2. 10 percent to the tobacco settlement trust fund.

Distribution Chart:

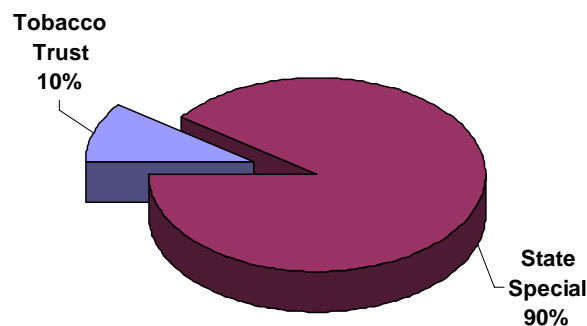

Collection Frequency: Trust interest earnings are deposited monthly to the state special revenue account and the trust.

% of Total General Fund Revenue: N/A

Revenue Estimate Methodology:

Data

The data used to estimate interest earnings from the tobacco settlement trust are obtained from the Board of Investments (BOI),

Legislative Fiscal Division

Revenue Estimate Profile

Tobacco Trust Interest

Global Insight, and the state accounting system (SABHRS). The BOI provides information on historic interest rates as well as the gains and losses from the sale of securities. Projections of future interest rates are provided by Global Insight and historic interest collections are obtained from SABHRS.

Analysis

The tobacco settlement trust, formed in 2000, was created from distributions of the tobacco settlement funds. In 2000, as required by constitutional amendment, the state began depositing 40 percent of the tobacco settlement funds into a trust. As required in statute, ten percent of the trust earnings must be deposited in the trust. The principal or corpus of the tobacco trust now stands at \$93.3 million, as shown by the line in the figure below. New deposits are expected to be \$14.9 million in fiscal 2009, \$15.1 million in fiscal 2010, and \$15.4 million in fiscal 2011.

To forecast the tobacco settlement trust interest earnings, each of three interest/income components are estimated independently and combined. The estimated interest/income components include:

- Trust funds bond pool (TFBP)
- Short-term investment pool (STIP)
- New trust deposits

The TFBP was formed in 1995 to manage the fixed investments held in the state's major trust funds. Each trust owns "shares" of the pool and interest earnings are paid to each trust on a per-share basis. TFBP earnings are the largest source of earnings for the trust, as shown in the figure below. To estimate TFBP earnings, the base year (fiscal 2008) rate of return generated by the pool, as reported by the BOI, is adjusted during the forecast period for maturing securities. The applicable new long-term rate for these securities is based on an average of four long-term rates projected by Global Insight. The fiscal year average long-term interest rate is expected to be 5.5 percent in fiscal years 2009 and 2010 and 5.7 percent in fiscal year 2011.

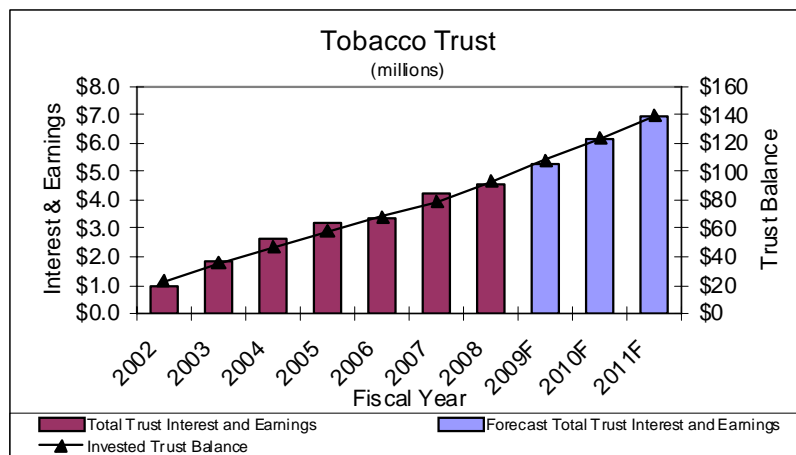

STIP interest (including other interest) is earned on cash, prior to investment in long-term investments. Funds are acquired from new deposits and/or maturing securities in the forecast period. Funds are held in STIP until the BOI determines that conditions are favorable for investment in the TFBP. To estimate future STIP earnings, an average short-term interest rate is developed, based on Global Insight projections of three short-term investments. The average of these rates is then converted to a fiscal year basis. The average fiscal year short-term interest rate is expected to be 1.5 percent in fiscal year 2009, 1.7 percent in fiscal year 2010, and 3.2 percent in fiscal year 2011.

The 40 percent distribution of tobacco settlement funds and 10 percent of retained interest earnings are considered new deposits in the tobacco settlement trust. New deposits are transferred to the trust on a quarterly basis. When the BOI receives the tobacco settlement funds, they are immediately invested in STIP. Funds are expected to remain in STIP for one month before being invested in the TFBP. The interest earned on new deposits is estimated by summing STIP earnings for one month with TFBP earnings for the remainder of the year.

Legislative Fiscal Division

Revenue Estimate Profile

Tobacco Trust Interest

Forecast Methodology:

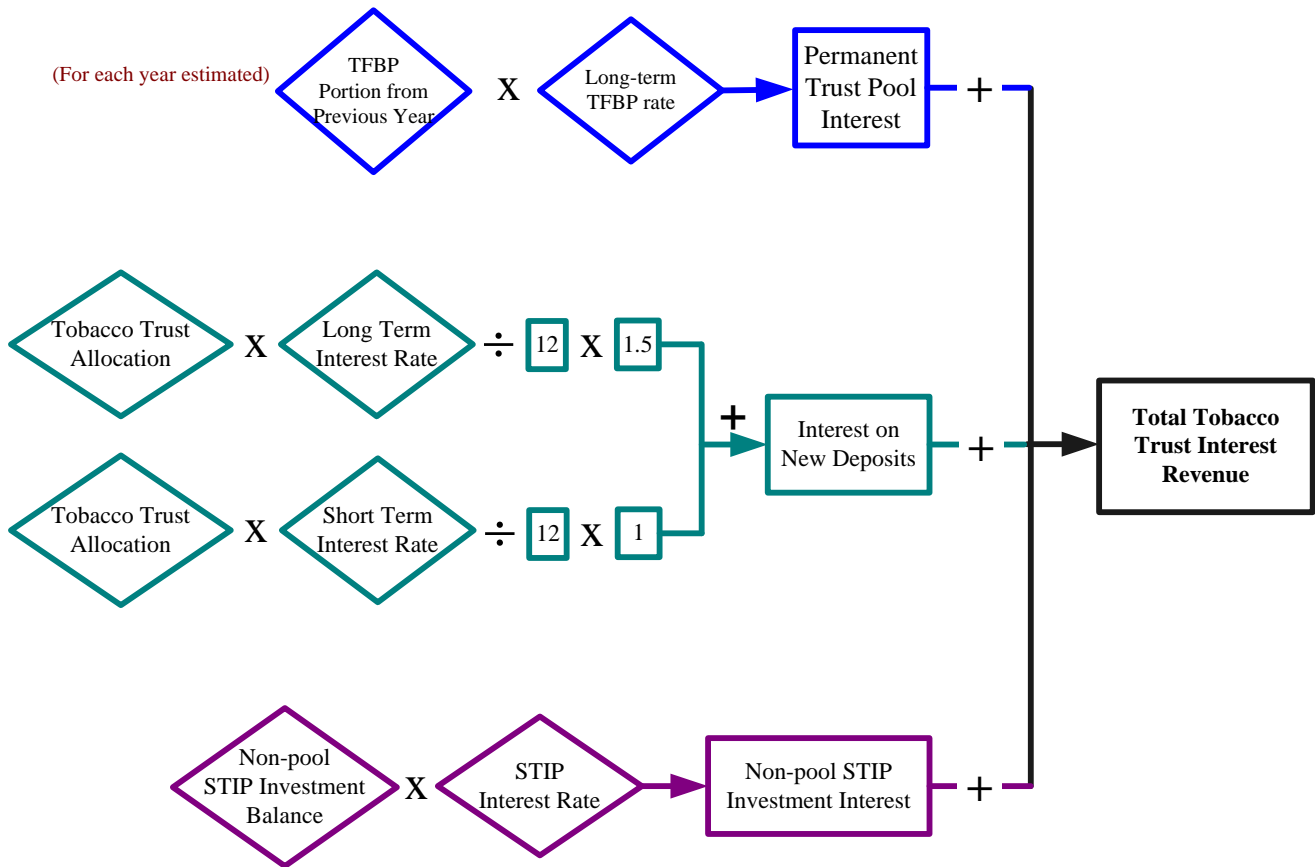

Legislative Fiscal Division

Revenue Estimate Profile

Tobacco Trust Interest

Revenue Estimate Assumptions:

	t	Total Rev.	GF Rev.	TFBP	STIP	90 Percent	10 Percent
	Fiscal	Millions	Millions	Interest	Interest	Interest	Interest
				Millions	Millions	Millions	Millions
Actual	2000	0.000000	0.000000				
Actual	2001	0.239625	0.000000				
Actual	2002	0.967687	0.000000	0.955252	0.012435		
Actual	2003	1.830214	0.000000	1.816256	0.013958	1.647000	0.183000
Actual	2004	2.669829	0.000000	2.661875	0.007953	2.403000	0.267000
Actual	2005	3.202336	0.000000	3.165725	0.036611	2.882000	0.320000
Actual	2006	3.387527	0.000000	3.320678	0.066848	3.049000	0.339000
Actual	2007	4.208268	0.000000	4.156125	0.052144	3.787000	0.421000
Actual	2008	4.545661	0.000000	4.524575	0.021084	4.091000	0.455000
Forecast	2009	5.299000	0.000000	5.271560	0.027769	4.769000	0.530000
Forecast	2010	6.121000	0.000000	6.089000	0.032050	5.509000	0.612000
Forecast	2011	6.987000	0.000000	6.924812	0.062636	6.288000	0.699000

	t	Tobacco	New Deposit	Non Pool	Non Pool	Invested	Average
	Fiscal	New Deposit	Long Term	STIP	STIP Bal	Balance	Return
		Millions	Rate	Rate	Millions	Millions	Rate
Actual	2000	0.000000	6.3380%	5.4290%	0.000000		
Actual	2001	10.650750	6.8850%	4.7390%	0.249457		
Actual	2002	12.432000	6.3380%	2.5650%	0.584877		
Actual	2003	12.563000	5.7290%	1.3600%	0.251155		
Actual	2004	10.852000	5.3650%	1.2650%	0.132682	46.756485	0.057101
Actual	2005	11.095000	5.1940%	2.3870%	2.853978	57.902493	0.055306
Actual	2006	10.261000	5.2340%	4.0770%	0.916926	68.175043	0.049689
Actual	2007	10.663000	5.4050%	4.7290%	0.493197	79.001067	0.053269
Actual	2008	14.267000	5.3790%	3.1940%	0.536632	93.294404	0.048724
Forecast	2009	14.861000	5.4900%	1.4970%	0.536632	122.422404	0.043287
Forecast	2010	15.123000	5.4780%	1.6830%	0.536632	137.545404	0.044502
Forecast	2011	15.439000	5.7480%	3.2000%	0.536632	152.984404	0.045674

Total Rev. = Invested Balance * Average Return

Legislative Fiscal Division

Revenue Estimate Profile Tobacco Trust Interest

Revenue Projection:

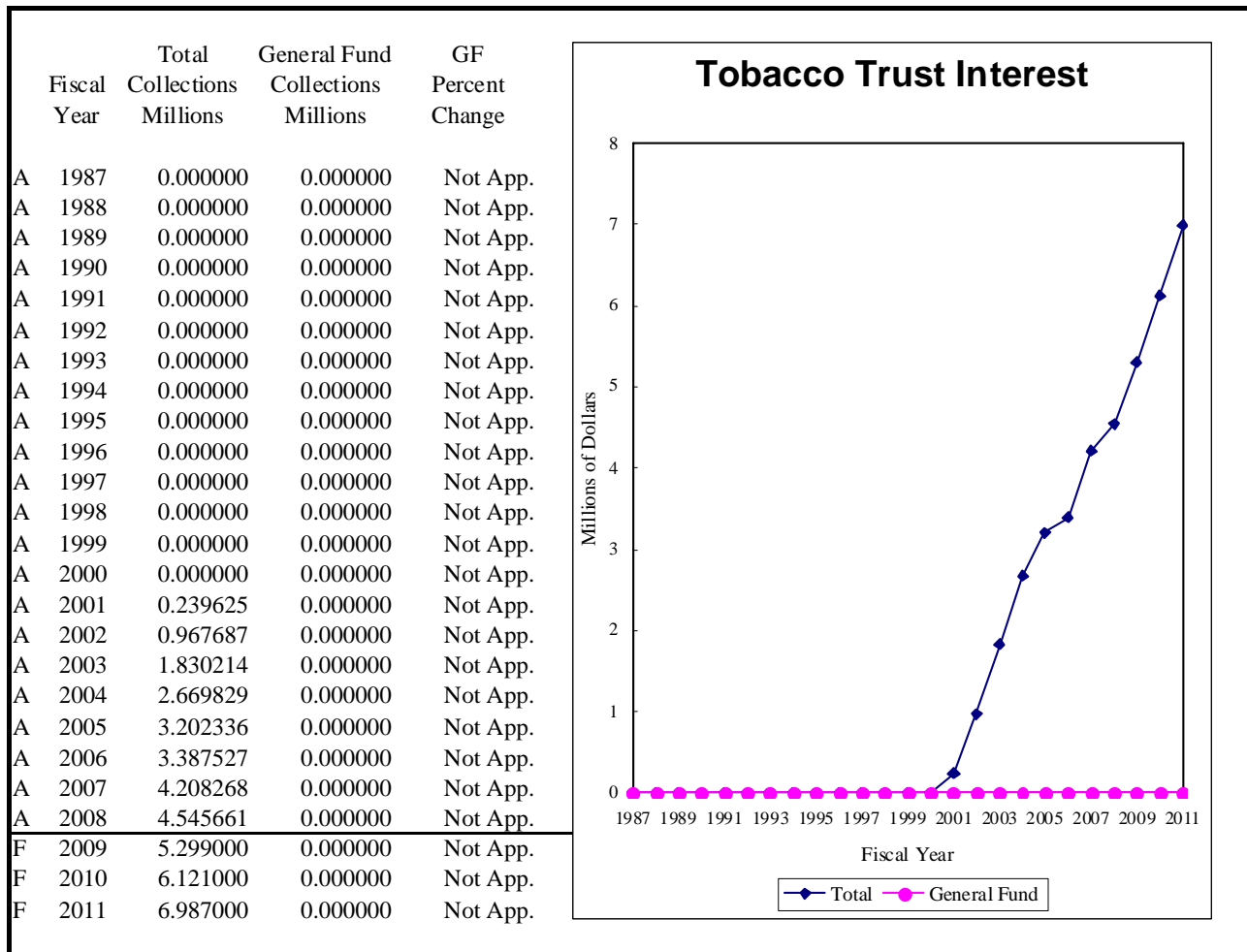

Data Source(s): Board of Investments, SABHRS, *Wall Street Journal*, Global Insight

Contacts: Department of Justice

Legislative Fiscal Division

Revenue Estimate Profile

Treasure State Endowment Trust Interest

Revenue Description: In the June 1992 election, voters approved a referendum to create the Treasure State Endowment Fund (TSEF) within the permanent coal tax trust fund. The TSEF received a \$10.0 million grant from the permanent trust principal in fiscal 1994 and received 37.5 percent of total coal severance tax collections from July 1999 through June 2003. Beginning fiscal 2004, the trust receives 25 percent of total collections. Interest earned on the TSEF is used to finance local infrastructure projects, as prioritized by the departments of Commerce and Natural Resources and Conservation and authorized by the legislature via the Treasure State Endowment Program (TSEP).

Statutory Reference:

Tax Rate – NA
Distribution (MCA) – 17-5-703 (4c); use of earnings (90-6-701(2))
Date Due (MCA) – Monthly (17-5-703 (4c))

Applicable Tax Rate(s): N/A

Distribution: Interest earnings are allocated to the Department of Commerce to fund TSEP.

Distribution Chart:

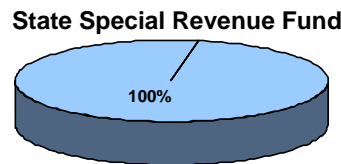

Collection Frequency: Monthly

% of Total General Fund Revenue: N/A

Revenue Estimate Methodology:

Data

The data used to estimate interest earnings from the treasure state endowment (TSE) trust is obtained from the Board of Investments (BOI), Global Insight, and the state accounting system (SABHRS). The BOI provides information on historic interest rates as well as the gains and losses from the sale of securities. Projections of future interest rates are provided by Global Insight and historic interest collections are obtained from SABHRS.

Analysis

The TSE trust was created from distributions of the coal severance tax. The TSE trust was formed early in the 1990's as a sub-trust to the permanent coal trust. The Constitution requires that 50 percent of the coal severance tax collections be distributed to the coal trust, and 50 percent of that distribution (after the water bond debt service obligation is met) or 25 percent of total coal severance tax revenues is distributed to the TSE trust. The principal or corpus of the TSE trust now stands at \$173.2 million. The estimates of future deposits to the TSE trust are developed in the coal severance tax projection and are expected to be \$10.7 million in fiscal 2009, \$11.5 million in fiscal 2010, and \$11.9 million in fiscal 2011.

To forecast the TSE trust interest earnings, each of four interest/income components are estimated independently and combined. The estimated interest/income components include:

- Trust funds bond pool (TFBP)
- In-state investments
- Short-term investment pool (STIP)
- New trust deposits

Legislative Fiscal Division

Revenue Estimate Profile

Treasure State Endowment Trust Interest

The TFBP was formed in 1995 to manage the fixed investments held in the state’s major trust funds. Each trust owns “shares” of the pool and interest earnings are paid to each trust on a per-share basis. TFBP earnings are the largest source of earnings for the trust, as shown in the figure below. To estimate TFBP earnings, the base year (fiscal 2008) rate of return generated by the pool, as reported by the BOI, is adjusted during the forecast period for maturing securities. The applicable new long-term rate for these securities is based on an average of four long-term rates projected by Global Insight. The fiscal year average long-term interest rate is expected to be 5.5 percent in fiscal years 2009 and 2010 and 5.7 percent in fiscal year 2011.

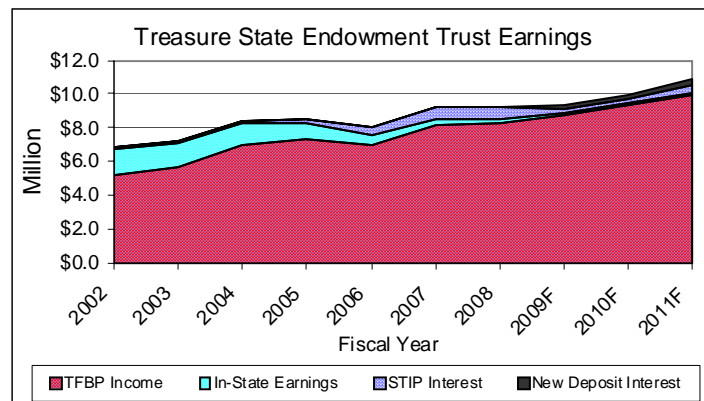

As seen in the figure above, earnings from in-state investments have historically been the second largest source of income to the TSE trust. The BOI is required by statute to invest twenty-five percent of coal tax trust in the Montana economy. Investments must be made to maximize the long-term benefit to the Montana economy. In-state investments primarily consist of loans to Montana business entities and earnings are equal to the interest charged on the loans. In the 2011 biennium, the loan rate is substantially lower than past years, 4.9 percent.

STIP interest (including other interest) is earned on cash, prior to investment in long-term investments. Funds are acquired from new deposits and/or maturing securities in the forecast period. Funds are held in STIP until the BOI determines that conditions are favorable for investment in the TFBP. To estimate future STIP earnings, an average short-term interest rate is developed, based on Global Insight projections of three short-term investments. The average of these rates is then converted to a fiscal year basis. The average fiscal year short-term interest rate is expected to be 1.5 percent in fiscal year 2009, 1.7 percent in fiscal year 2010, and 3.2 percent in fiscal year 2011.

Coal severance tax distributions to the TSE trust are considered new deposits. New deposits are transferred to the trust on a quarterly basis. When the BOI receives the coal tax transfer, the funds are immediately invested in STIP. Funds are expected to remain in STIP for one month before being invested in the TFBP. The interest earned on new deposits is estimated by summing STIP earnings for one month with TFBP earnings for the remainder of the year.

Legislative Fiscal Division

Revenue Estimate Profile

Treasure State Endowment Trust Interest

Forecast Methodology:

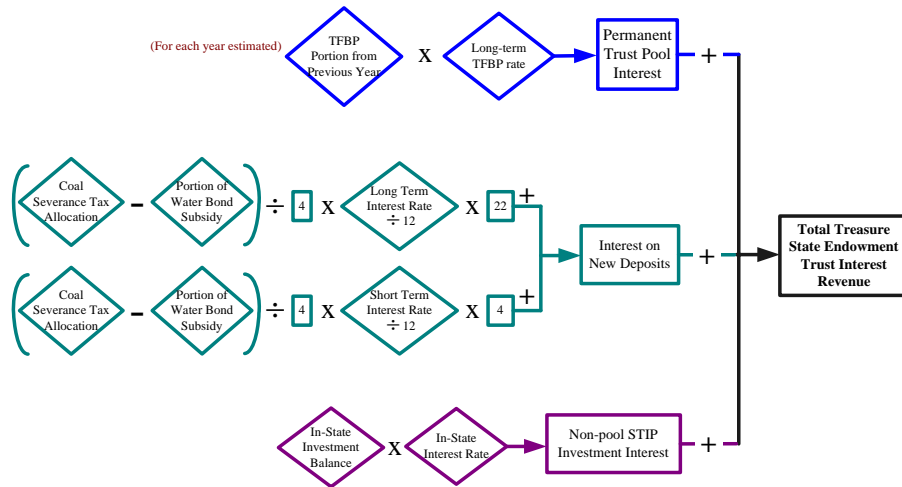

Revenue Estimate Assumptions:

	t	Total Rev.	GF Rev.	TFBP	STIP	Loan	Invested	Average
	Fiscal	Millions	Millions	Interest	Interest	Interest	Balance	Return
				Millions	Millions	Millions	Millions	Rate
Actual	2000	5.123374	0.000000					
Actual	2001	5.801525	0.000000					
Actual	2002	6.804839	0.000000	5.139577	0.134725	1.530537		
Actual	2003	7.175069	0.000000	5.718544	0.091977	1.364547		
Actual	2004	8.349481	0.000000	6.929583	0.085931	1.333115	127.175885	0.065653
Actual	2005	8.481564	0.000000	7.272317	0.236790	0.970369	137.335617	0.061758
Actual	2006	8.038515	0.000000	7.001103	0.514071	0.523204	147.150621	0.054628
Actual	2007	9.224883	0.000000	8.101840	0.719283	0.403746	161.366192	0.057167
Actual	2008	9.194019	0.000000	8.296236	0.638806	0.258977	172.310051	0.053357
Forecast	2009	9.339000	0.000000	8.702680	0.523192	0.113171	194.308019	0.048063
Forecast	2010	9.989000	0.000000	9.288189	0.588045	0.113171	205.790019	0.048542
Forecast	2011	10.938000	0.000000	9.917173	0.907776	0.113171	217.719019	0.050240

	t	Net Coal Tax	New Deposit	Non Pool	Non Pool	Non Pool	Non Pool
	Fiscal	New Deposit	Long Term	STIP	Loan	STIP Bal	Loan Bal
		Millions	Rate	Rate	Rate	Millions	Millions
Actual	2000	13.301172	7.0160%	5.4290%	0.0000%	12.385400	0.000000
Actual	2001	12.126440	6.8850%	4.7390%	0.0000%	4.384216	19.223452
Actual	2002	11.855268	6.3380%	2.5650%	8.2549%	7.426826	17.858672
Actual	2003	11.033830	5.7290%	1.3600%	7.4418%	11.674509	18.813738
Actual	2004	7.886171	5.3650%	1.2650%	8.2678%	10.526991	13.434570
Actual	2005	9.408628	5.1940%	2.3870%	8.7756%	12.141430	8.680571
Actual	2006	8.955381	5.2340%	4.0770%	7.1089%	11.708362	6.039199
Actual	2007	10.189685	5.4050%	4.7290%	7.4842%	14.763620	4.750104
Actual	2008	11.332968	5.3790%	3.1940%	7.5444%	14.042401	2.115350
Forecast	2009	10.665000	5.4900%	1.4970%	5.3500%	14.042401	2.115350
Forecast	2010	11.482000	5.4780%	1.6830%	5.3500%	14.042401	2.115350
Forecast	2011	11.929000	5.7480%	3.2000%	5.3500%	14.042401	2.115350

Total Rev. = Invested Balance * Average Return

Legislative Fiscal Division

Revenue Estimate Profile

Treasure State Endowment Trust Interest

Revenue Projection:

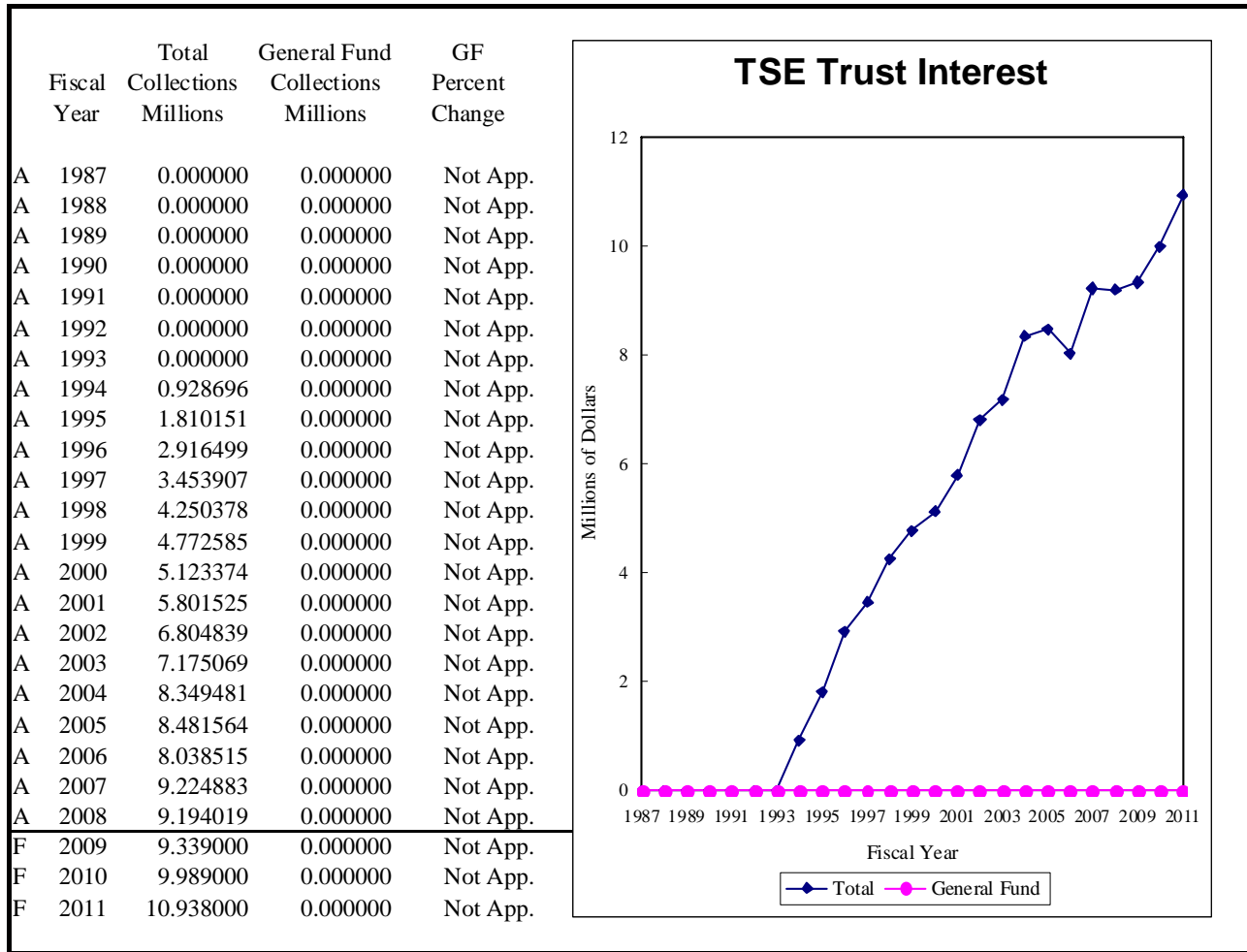

Data Source(s): Board of Investments, SABHRS, *Wall Street Journal*, Global Insight

Contacts: Department of Commerce and Department of Natural Resources and Conservation

Legislative Fiscal Division

Revenue Estimate Profile

Treasury Cash Account Interest

Revenue Description: The Department of Commerce, Board of Investments is responsible for investing all state funds. Title 17, Chapter 6, MCA, provides guidelines under which the funds must be invested. Unless specifically stated by statute, all interest earned on these investments is deposited in the general fund. Treasury cash is invested in a mixture of short and medium-term investments. Consequently, the interest assumptions adopted by the legislature incorporate a blend of short and intermediate-term rates. When needed to address cash flow problems, the state typically issues tax and revenue anticipation notes (TRANS). The legislature would then adopt TRANS issuance assumptions, since this affects the average invested balance. No TRANS issues are anticipated in the 2009 or 2011 biennia.

Statutory Reference:

Tax Rate – NA

Distribution (MCA) – 17-6-202(2)

Date Due – interest deposits are mostly made monthly, with two in June and none in July

Applicable Tax Rate(s): N/A

Distribution: All investment earnings on the treasury cash account (TCA) are deposited into the general fund.

Distribution Chart:

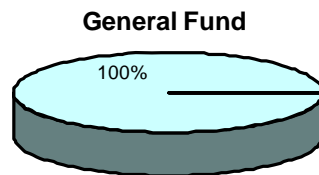

Collection Frequency: On-going

% of Total General Fund Revenue:

FY 2004 – 0.46%

FY 2007 – 1.85%

FY 2005 – 0.66%

FY 2008 – 1.57%

FY 2006 – 1.09%

Revenue Estimate Methodology:

Excess cash in the state treasury is deposited to the treasury cash account (TCA) and invested in short and medium-term investments. Earnings are dependent on the investable cash balance and interest rates. Investment earnings are deposited to the general fund.

Data

The Board of Investments provides monthly reports on the treasury cash account balance. The state accounting system (SABHRS) provides information on monthly investment earnings.

Analysis

- The average balance of the TCA is estimated by increasing the previous year's balance by half the difference between the anticipated general fund balances for the past and current years. When cash flow is insufficient, tax revenue anticipation notes (TRANS) are issued to meet short-term cash flow needs. The term of the loan and amount borrowed are used to determine the amount to be added to the average balance calculations. No TRANS are anticipated for FY 2009 -2011.

Legislative Fiscal Division

Revenue Estimate Profile

Treasury Cash Account Interest

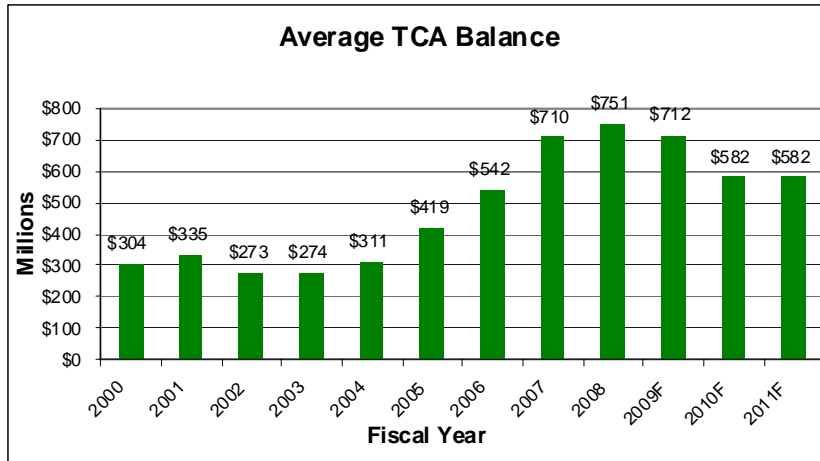

- Short-term interest rates are estimated by first deriving a composite rate of Global Insight forecasts for the 3-month commercial paper, 3-month treasury bill, and 6-month treasury bill rates. A ratio is then developed of the sum of average TCA rate for FY 2006-FY 2008 to sum of the composite rate for the same years. The ratio is then multiplied by the composite rate for the applicable year.

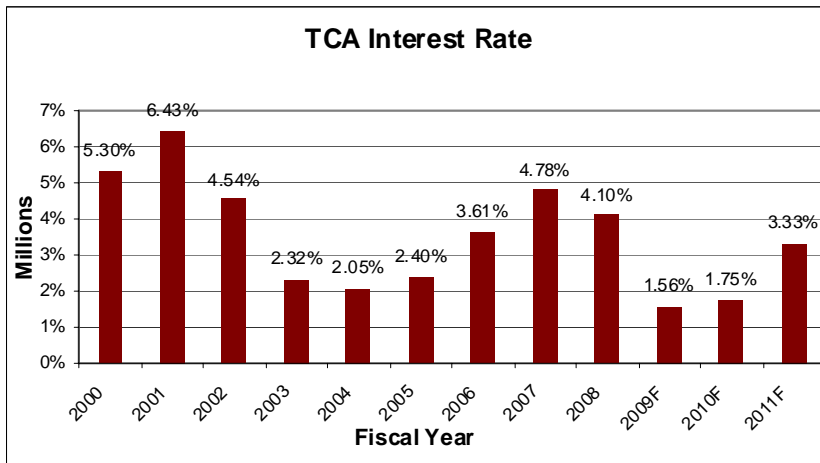

Adjustments and Distribution

Once total revenue for each fiscal year is determined, the applicable distribution percentage, 100 percent to the general fund, is applied.

Legislative Fiscal Division

Revenue Estimate Profile

Treasury Cash Account Interest

Forecast Methodology:

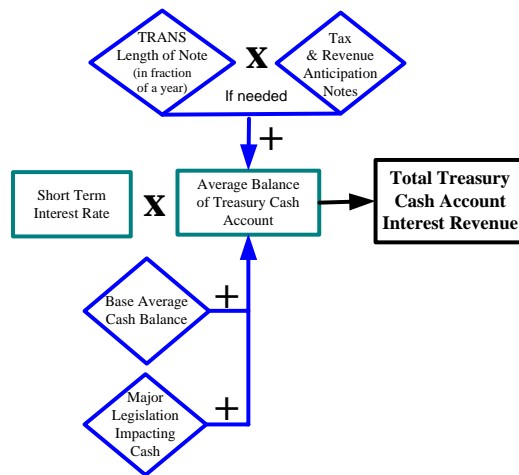

Revenue Estimate Assumptions:

	t	Total Rev.	GF Rev.	Avg. Bal.	Interest	Issue	TRANS
	Fiscal	Millions	Millions	Millions	Rate	Rate	Cost
Actual	2000	16.088271	16.088271	303.627590	0.052987	0.000000	0.000000
Actual	2001	21.531903	21.531903	334.705188	0.064331	0.000000	0.000000
Actual	2002	12.414382	12.414382	273.343304	0.045417	0.000000	0.000000
Actual	2003	6.366439	6.366439	273.928913	0.023241	0.026498	1.639327
Actual	2004	6.392992	6.392992	311.477974	0.020525	0.002027	0.099188
Actual	2005	10.046531	10.046531	419.348957	0.023957	0.000000	0.000000
Actual	2006	18.631288	18.631288	542.420040	0.036108	0.000000	0.000000
Actual	2007	33.951447	33.951447	710.102066	0.047812	0.000000	0.000000
Actual	2008	30.782748	30.782748	750.830709	0.040998	0.000000	0.000000
Forecast	2009	11.107000	11.107000	711.991709	0.015600	0.010072	0.000000
Forecast	2010	10.185000	10.185000	581.991709	0.017500	0.011299	0.000000
Forecast	2011	19.381000	19.381000	581.991709	0.033300	0.021500	0.000000

	t	Base Bal.	TRANS	TRANS
	Fiscal	Millions	Millions	Length
Actual	2000	303.628000	0.000000	0.000000
Actual	2001	334.705000	0.000000	0.000000
Actual	2002	273.343000	0.000000	0.000000
Actual	2003	212.062000	92.800000	0.666667
Actual	2004	262.545000	73.400000	0.666667
Actual	2005	419.349000	0.000000	0.000000
Actual	2006	542.420000	0.000000	0.000000
Actual	2007	710.102000	0.000000	0.000000
Actual	2008	750.831000	0.000000	0.000000
Forecast	2009	711.992000	0.000000	0.000000
Forecast	2010	581.992000	0.000000	0.000000
Forecast	2011	581.992000	0.000000	0.000000

Total Rev. = Average Balance * Interest Rate
 GF Rev = Total Rev.

Legislative Fiscal Division

Revenue Estimate Profile

Treasury Cash Account Interest

Revenue Projection:

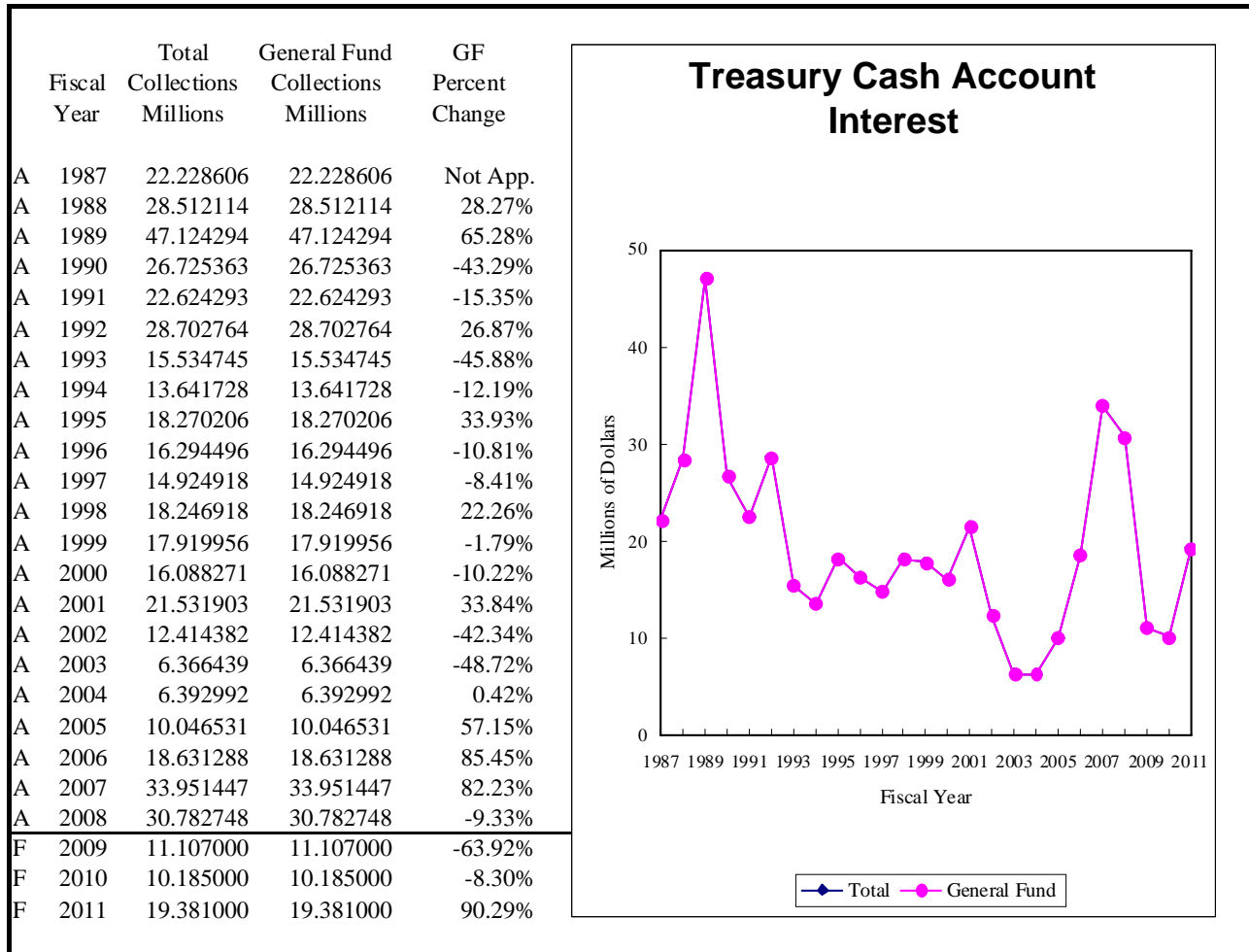

Data Source(s): SABHRS, Department of Administration, *Wall Street Journal*, Global Insight

Contacts: Department of Administration