

# Interest Earnings

**Capital Land Grant  
Coal Trust Interest  
Common School Interest & Income  
Cultural & Aesthetics Trust Interest  
Deaf & Blind Trust Interest  
Economic Development Trust Interest  
Parks Trust Interest  
Pine Hills Trust Interest  
Regional Water Trust Interest  
Resource Indemnity Trust Interest  
Tobacco Settlement Trust Interest  
Treasure State Endowment Trust Interest  
Treasury Cash Account Interest**

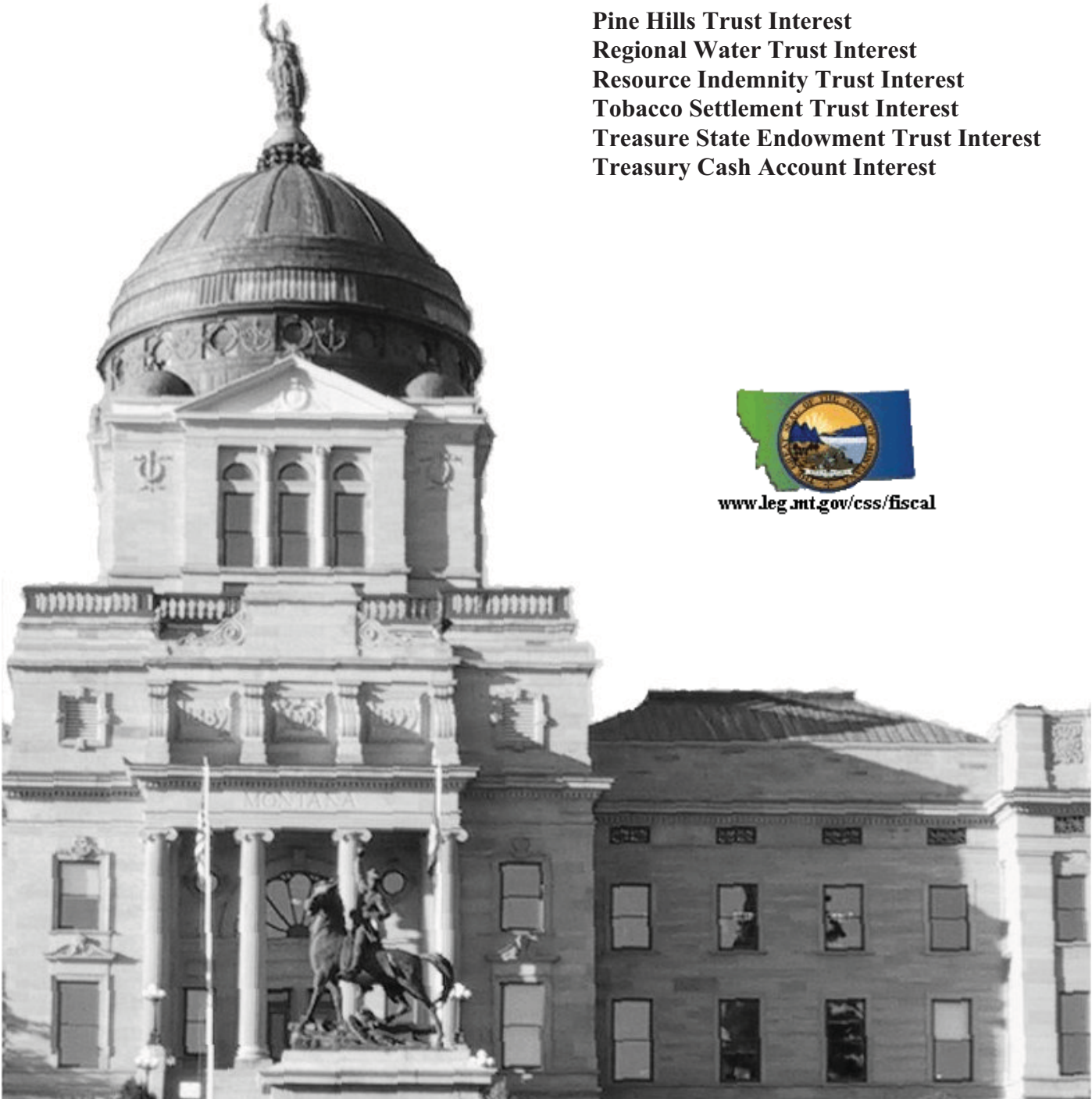

---

# Legislative Fiscal Division

## Revenue Estimate Profile

### Capital Land Grant Interest and Income

---

**Revenue Description:** Lands granted by the federal government to the state generate income from a variety of sources. Section 12 of the *Enabling Act* requires that income generated on certain sections of federally granted land be used for public buildings at the state capital for construction, repair, renovation, and other permanent improvements of state buildings. Capital land grant funds can also be used for the acquisition of land for such buildings, as well as the payment of principal and interest on bonds issued for any of these purposes.

Non-permanent sources of revenue generated from capital land grant lands include: grazing fees, agricultural fees, miscellaneous fees and rentals, and oil and natural gas leases and penalties. Senate Bill 65, enacted by the 2009 Legislature, allows an amount up to 25% of distributable revenue to be diverted to the trust land administration account to fund DNRC administrative costs. Permanent sources of revenue generated from capital land grant lands include timber sales and oil and natural gas royalties. All sources of revenue are subject for diversion to DNRC for administration.

#### Statutory Reference:

- Tax Rate – NA
- Tax Distribution (MCA) – 18-2-107
- Enabling Act, Sections 10, 12 & 17
- Other (MCA) – DNRC trust land administration diversion (77-1-108 & 109)  
DNRC land bank administration diversion (77-2-362)

**Applicable Tax Rate(s):** N/A

**Distribution:** After diversions for DNRC administration, all remaining capital land grant income is deposited into a capital projects fund to be used for projects on the state capital complex in accordance with the provisions of Section 12 of the *Enabling Act*.

#### Distribution Chart:

**Capital Projects Fund**

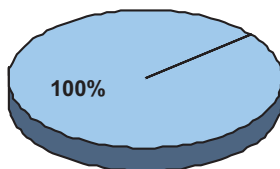

**Collection Frequency:** Monthly

**% of Total General Fund Revenue:** N/A

#### Revenue Estimate Methodology:

The estimate for interest and income from the capital land grant trust determines the net amount of revenue that will be distributed to the trust beneficiary. This means that in addition to estimating the various revenues from the capital land grant trust, estimates of the diversion for DNRC administration costs that reduce the amount of revenue deposited to the capital program fund must also be estimated. Therefore, the estimated amounts shown for this revenue source are not total revenues, but are net of diversions. Since all of the trust income is distributed, the trust has no monetary corpus.

#### Data

Data from SABHRS provide a history of each individual interest and income revenue component from which estimates can be made. Department of Natural Resources and Conservation (DNRC) annual reports provide additional information such as mineral prices and production. Budget submissions on the state budgeting system (MBARS) provide anticipated amount of

# Legislative Fiscal Division

## Revenue Estimate Profile

### Capital Land Grant Interest and Income

diversions.

#### Analysis

The estimate is derived by first estimating the revenue components and then estimating the diversion amount.

#### Revenue Components

1. Timber – Estimates of timber harvest from capital land grant trust lands are taken directly from DNRC estimates.
2. Grazing Fees – Rates are tied to the price of cattle. Cattle prices are expected to be close to those experienced in FY 2010, perhaps slightly less. DNRC personnel anticipate the grazing fee revenue will be similar to FY 2010.

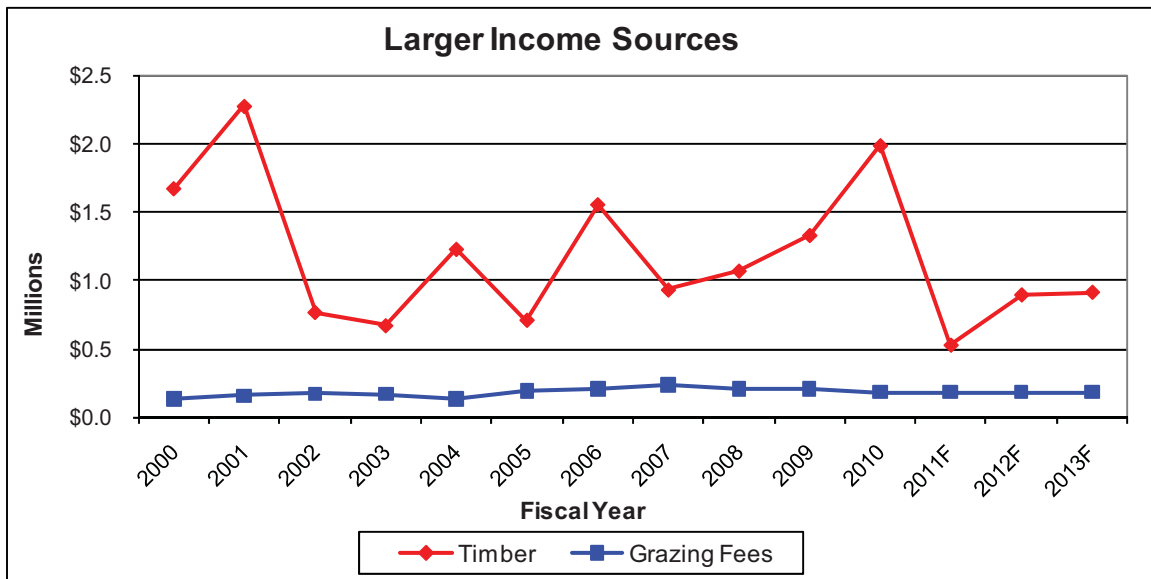

3. Miscellaneous Rentals - These are small income components that are combined and estimated together. For each fiscal year estimated, the estimate is based on the average annual growth rate of the previous four years with the highest and lowest amounts removed.
4. Agricultural Fees - Fees are based on a crop share basis. Commodity prices are expected to be about the same as FY 2010 resulting in similar returns.
5. Oil & Gas Bonuses - Estimates continue the amount received in FY 2010.
6. Oil & Gas Leases – For each fiscal year estimated, the estimate is the average of the previous nine years with the highest and lowest years discarded.
7. Mineral Royalties – Mineral royalties are received from oil and natural gas. Royalties are estimated by increasing the previous fiscal year’s production by the growth rate obtained from average annual growth from for the previous 15 years with the highest and lowest years discarded.
8. Oil & Gas Penalties – For each fiscal year estimated, the estimate is the average of the previous two years.

# Legislative Fiscal Division

## Revenue Estimate Profile

### Capital Land Grant Interest and Income

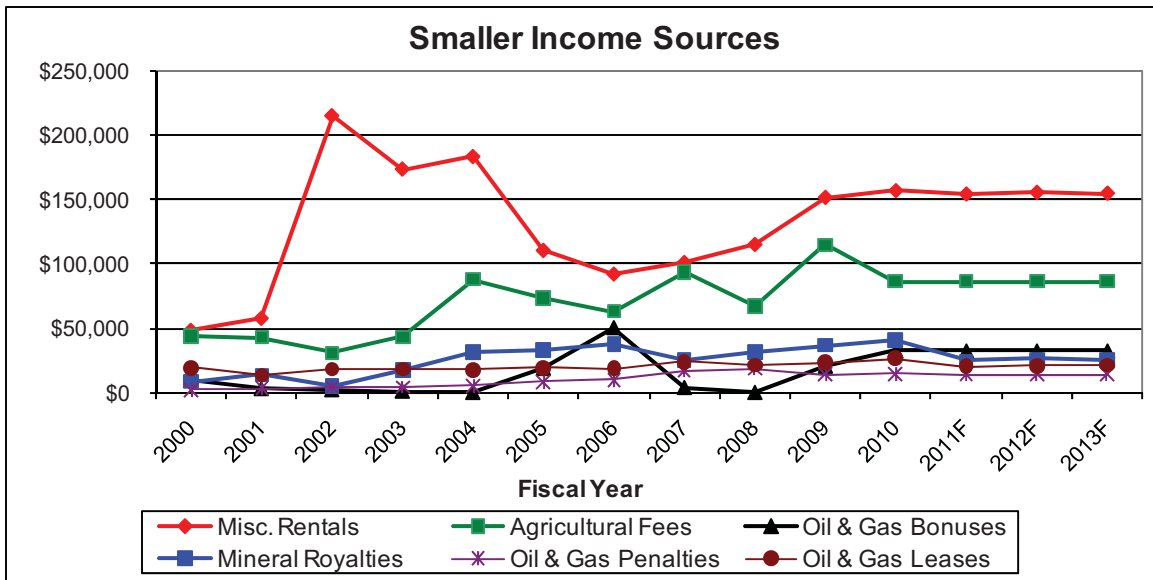

Diversion

The diversion amount fund operational costs in DNRC, but reduce the amount of revenue distributed to the trust beneficiaries (see the figure below). To determine future diversion amounts, DNRC's present law budget amounts are used.

1. Trust Land Administration Account – Of the total expenditures requested to be made from this account, a portion is funded by capital land grant trust revenue. That portion is determined by multiplying current year revenue estimates by the ratio of FY 2010 costs that this trust paid to the total administration costs. In FY 2010, the capital land grant trust funded 8.4% of total expenditures.

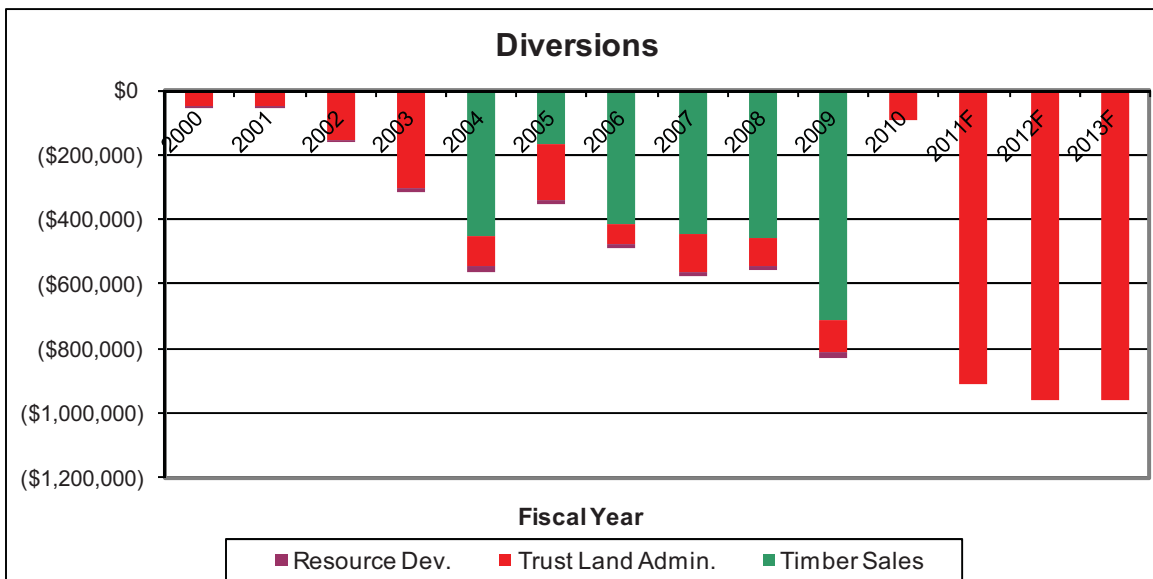

Adjustments and Distribution

Once total revenue and total diversions have been estimated, the net amounts are distributed to the capital project fund.

# Legislative Fiscal Division

## Revenue Estimate Profile

### Capital Land Grant Interest and Income

**Forecast Methodology:**

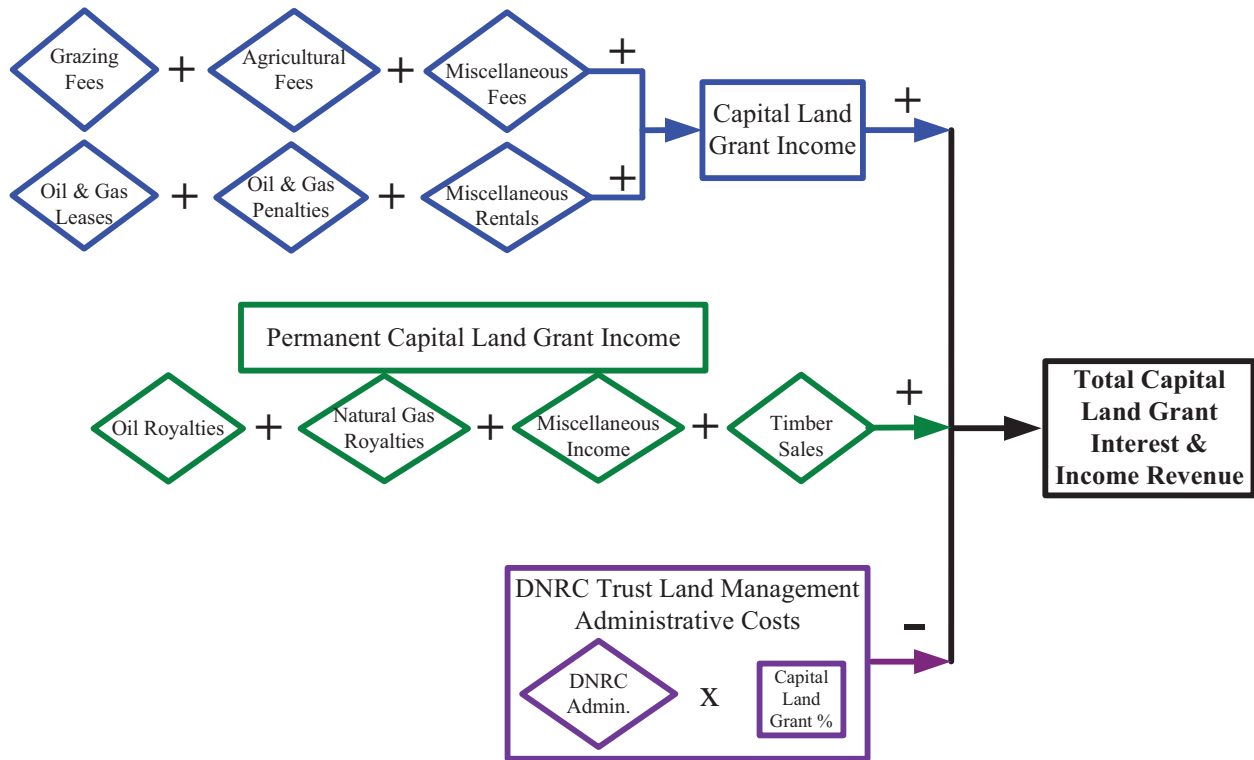

**Legislative Fiscal Division**  
**Revenue Estimate Profile**  
**Capital Land Grant Interest and Income**

**Revenue Estimate Assumptions:**

	t	Total Rev.	GF Rev.	TFBP	STIP	Capital
	<u>Fiscal</u>	<u>Millions</u>	<u>Millions</u>	<u>Interest</u>	<u>Interest</u>	<u>Land Share</u>
				<u>Millions</u>	<u>Millions</u>	<u>T&amp;L</u>
Actual	2000	1.920809	0.000000			0.000000
Actual	2001	2.527118	0.000000			0.000000
Actual	2002	1.065036	0.000000	29.627056	0.102664	0.000000
Actual	2003	0.808807	0.000000	29.146744	0.068370	0.000000
Actual	2004	1.976678	0.000000	30.087011	0.053502	0.000000
Actual	2005	0.853171	0.000000	28.106281	0.269698	0.000000
Actual	2006	1.589963	0.000000	24.428206	0.408162	0.000000
Actual	2007	0.870700	0.000000	26.206838	0.267652	0.000000
Actual	2008	0.982735	0.000000	25.159580	0.128925	0.000000
Actual	2009	1.077717	0.000000	22.711371	0.066450	0.000000
Actual	2010	1.635490	0.000000	22.916114	0.018370	0.000000
Forecast	2011	0.144000	0.000000	21.081910	0.427096	0.000000
Forecast	2012	0.470000	0.000000	22.008854	0.494929	0.000000
Forecast	2013	0.486000	0.000000	22.862477	0.859802	0.000000

	t	Trust Income	Trust Land	New Deposit	Non Pool	Non Pool
	<u>Fiscal</u>	<u>New Deposit</u>	<u>Admin.</u>	<u>Long Term</u>	<u>STIP</u>	<u>STIP Bal</u>
		<u>Millions</u>	<u>Millions</u>	<u>Rate</u>	<u>Rate</u>	<u>Millions</u>
Actual	2000	10.969295		7.0160%	5.4290%	11.676486
Actual	2001	12.667780	-0.048140	6.8850%	4.7390%	6.984553
Actual	2002	2.348339	-0.151480	6.3380%	2.5650%	7.334239
Actual	2003	2.363355	-0.305417	5.7290%	1.3600%	6.242273
Actual	2004	2.971526	-0.098964	5.3650%	1.2650%	7.049634
Actual	2005	1.457756	-0.172683	5.1940%	2.3870%	12.106697
Actual	2006	1.425106	-0.062659	5.2340%	4.0770%	3.862666
Actual	2007	7.173844	-0.114745	5.4050%	4.7290%	14.953757
Actual	2008	3.101654	-0.085035	5.3180%	3.1650%	2.461097
Actual	2009	4.125990	-0.103893	5.1210%	0.9770%	4.161322
Actual	2010	10.709883	0.000000	4.7440%	0.2120%	11.339709
Forecast	2011	21.996772	0.000000	4.2140%	0.2500%	11.339709
Forecast	2012	20.524718	0.000000	4.1590%	0.9150%	11.339709
Forecast	2013	22.106856	0.000000	5.0340%	2.5430%	11.339709

**Legislative Fiscal Division**  
**Revenue Estimate Profile**  
**Capital Land Grant Interest and Income**

	<u>t</u> <u>Fiscal</u>	<u>Grazing</u> <u>Millions</u>	<u>Agriculture</u> <u>Millions</u>	<u>Misc.</u> <u>Millions</u>	<u>O&amp;G Lease</u> <u>Millions</u>	<u>O&amp;G Bonus</u> <u>Millions</u>	<u>O&amp;G Penalty</u> <u>Millions</u>	<u>Misc.</u> <u>Millions</u>
Actual	2000	0.132580	0.044452	0.000000	0.019153	0.009104	0.002343	0.048046
Actual	2001	0.159924	0.043153	0.000000	0.013722	0.002980	0.003287	0.057476
Actual	2002	0.173945	0.030825	0.000000	0.018286	0.002180	0.004428	0.215148
Actual	2003	0.170050	0.043195	0.000000	0.018497	0.001020	0.004170	0.173664
Actual	2004	0.132298	0.088177	0.000000	0.017818	0.000000	0.005399	0.183365
Actual	2005	0.197466	0.073605	0.000000	0.019107	0.018820	0.008633	0.110300
Actual	2006	0.210403	0.063134	0.000000	0.019001	0.050616	0.010166	0.091908
Actual	2007	0.238825	0.093304	0.000000	0.024241	0.003840	0.016487	0.100922
Actual	2008	0.206167	0.067380	0.000000	0.021340	0.000040	0.018223	0.114930
Actual	2009	0.208119	0.114908	0.000000	0.023393	0.020553	0.014142	0.151604
Actual	2010	0.184857	0.086636	0.000000	0.026553	0.032360	0.014442	0.156829
Forecast	2011	0.184857	0.086636	0.000000	0.020552	0.032360	0.014292	0.154217
Forecast	2012	0.184857	0.086636	0.000000	0.020876	0.032360	0.014367	0.155523
Forecast	2013	0.184857	0.086636	0.000000	0.021216	0.032360	0.014330	0.154870

	<u>t</u> <u>Fiscal</u>	<u>Int. Land</u> <u>Millions</u>	<u>Int. STIP</u> <u>Millions</u>	<u>Int. Trust</u> <u>Millions</u>	<u>Res. Dev.</u> <u>Millions</u>	<u>Lease Total</u> <u>Millions</u>	<u>Timber Cost</u> <u>Millions</u>	<u>TLMD Adm.</u> <u>Millions</u>
Actual	2000	0.000000	0.000000	0.000000	-0.007670	0.248008		
Actual	2001	0.000000	0.000000	0.000000	-0.008268	0.272274		
Actual	2002	0.000000	0.000000	0.000000	-0.008838	0.435974		
Actual	2003	0.000000	0.000000	0.000000	-0.009311	0.401285	0.000000	
Actual	2004	0.000000	0.000000	0.000000	-0.012622	0.414435	-0.448435	
Actual	2005	0.000000	0.000000	0.000000	-0.009255	0.418676	-0.168515	
Actual	2006	0.000000	0.000000	0.000000	-0.012793	0.432435	-0.412498	
Actual	2007	0.000000	0.000000	0.000000	-0.013814	0.463805	-0.445082	
Actual	2008	0.000000	0.000000	0.000000	-0.012794	0.415286	-0.456737	
Actual	2009	0.000000	0.000000	0.000000	-0.014616	0.518103	-0.708610	
Actual	2010	0.000000	0.000000	0.000000	0.000000	0.501677	0.000000	-0.915300
Forecast	2011	0.000000	0.000000	0.000000	0.000000	0.492914	0.000000	-0.911888
Forecast	2012	0.000000	0.000000	0.000000	0.000000	0.494619	0.000000	-0.957699
Forecast	2013	0.000000	0.000000	0.000000	0.000000	0.494269	0.000000	-0.960665

**Legislative Fiscal Division**  
**Revenue Estimate Profile**  
**Capital Land Grant Interest and Income**

	<u>t</u> <u>Fiscal</u>	<u>Oil Roy.</u> <u>Millions</u>	<u>Gas Roy.</u> <u>Millions</u>	<u>Timber</u> <u>Millions</u>	<u>Misc.</u> <u>Millions</u>	<u>Perm. Total</u> <u>Millions</u>
Actual	2000	0.004394	0.004489	1.675671	0.028247	1.712801
Actual	2001	0.005659	0.008068	2.278363	0.010894	2.302984
Actual	2002	0.003264	0.002190	0.769197	0.005891	0.780542
Actual	2003	0.004461	0.013330	0.671819	0.023329	0.712939
Actual	2004	0.003492	0.027817	1.231369	0.846964	1.661207
Actual	2005	0.005271	0.027867	0.712329	0.030226	0.607178
Actual	2006	0.005020	0.033062	1.558251	0.036352	1.220187
Actual	2007	0.006658	0.018361	0.933816	0.007887	0.521640
Actual	2008	0.008281	0.023358	1.072080	0.005502	0.652484
Actual	2009	0.006707	0.030089	1.332642	0.006570	0.667398
Actual	2010	0.016586	0.024197	1.990487	0.016586	2.047856
Forecast	2011	0.004972	0.019576	0.529585	0.009136	0.563269
Forecast	2012	0.005289	0.020929	0.897912	0.009449	0.933579
Forecast	2013	0.005473	0.019826	0.917140	0.010435	0.952874

Total Rev. = Grazing + Agriculture + O&G Lease + O&G Bonus + O&G Penalty + Misc. +  
 Int. Land + Int. Stip + Int. Trust + Timber + Res. Dev. + Oil Roy. + Gas Roy. + Timber + Misc. +  
 Timber Cost + Trust Land Admin.



# Legislative Fiscal Division

## Revenue Estimate Profile

### Capital Land Grant Interest and Income

**Revenue Projection:**

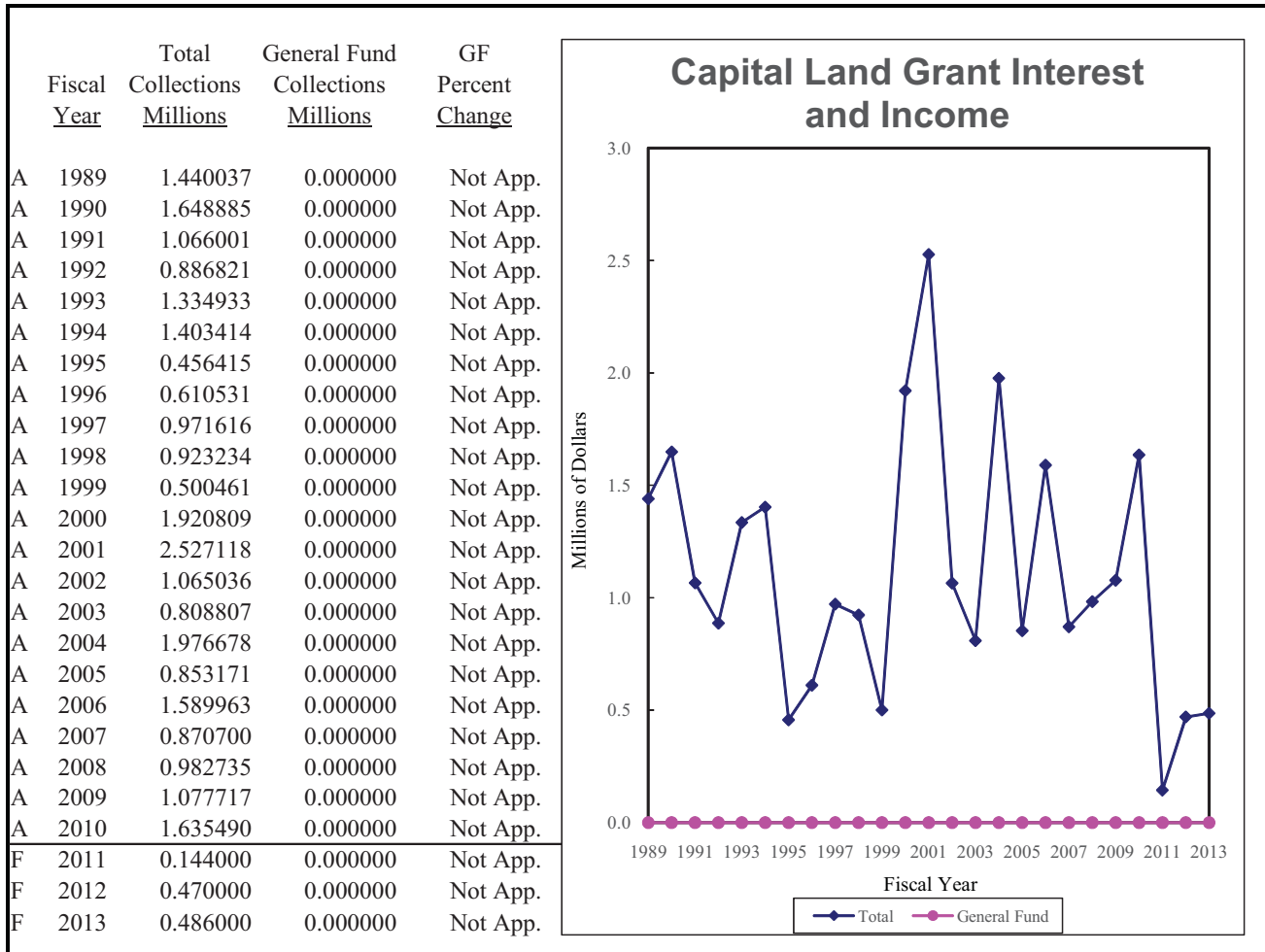

**Data Source(s):** SABHRS, *Wall Street Journal*, Department of Natural Resources and Conservation

**Contacts:** Department of Administration, Department of Natural Resources and Conservation

---

# Legislative Fiscal Division

## Revenue Estimate Profile

### Coal Trust Interest

---

**Revenue Description:** Article IX, Section 5 of the Montana Constitution requires that 50% of all coal severance tax revenue be deposited in a permanent coal trust fund and that the principal of the trust "shall forever remain inviolate unless appropriated by a three-fourths vote of each house". Coal severance tax funds flowing into the trust fund are first used to secure and subsidize state bonds issued to finance water resource and renewable resource development projects and activities. With the enactment of House Bill 249 by the 2005 Legislature, beginning FY 2006 the remaining funds are then split 50% (25% of total revenue) to the treasure state endowment trust fund, 25% (12.5% of total revenue) to the treasure state endowment regional water system trust fund, and 25% (12.5% of total revenue) to the big sky economic development trust fund. The permanent trust fund no longer receives coal severance tax revenue. By statute, interest earned on the permanent trust that is not earmarked to other programs is deposited to the general fund. When calculating interest earnings, the impact of loans made from the trust, such as the in-state investment program, is taken into account.

As of October 1, 1995, all fixed-income investments held by the state's major trust funds were transferred to a newly-created trust fund bond pool (TFBP). The majority of permanent coal tax trust funds are invested as part of the TFBP. Some funds, however, are invested on a short-term basis in the state's short-term investment pool (STIP). In addition, state law provides that trust funds may be used for in-state commercial loans to stimulate economic development. The state Constitution prohibits the investment of the permanent trust in common stock.

#### Statutory Reference:

Tax Rate - NA

Distribution (MCA) - Montana Constitution, Article IX, Section 5; 17-5-704; 15-35-108

Date Due - NA

**Applicable Tax Rate(s):** N/A

**Distribution:** Interest earned on the permanent coal tax trust fund is deposited into the general fund. Statute further annually statutorily appropriates interest income from \$140 million of the coal severance tax permanent fund as follows:

#### FY 2006 - 2010

\$3,650,000 – to the research and commercialization state special revenue account

\$1,250,000 – for the growth through agriculture program

\$425,000 – to the Department of Commerce for certified regional development corporations

\$300,000 – to the Department of Commerce for export trade enhancement

\$200,000 – to the Department of Commerce for the Montana manufacturing extension center at MSU-Bozeman

\$125,000 – to the Department of Commerce for a small business development center

\$65,000 – to the Cooperative Development Center

\$50,000 – to the Department of Commerce for a small business innovative research program

\$6,065,000

#### FY 2011 - 2013

\$1,275,000 – to the research and commercialization state special revenue account

\$625,000 – for the growth through agriculture program

\$425,000 – to the Department of Commerce for certified regional development corporations

\$300,000 – to the Department of Commerce for export trade enhancement

\$200,000 – to the Department of Commerce for the Montana manufacturing extension center at MSU-Bozeman

\$125,000 – to the Department of Commerce for a small business development center

\$65,000 – to the Cooperative Development Center

\$50,000 – to the Department of Commerce for a small business innovative research program

\$3,065,000

# Legislative Fiscal Division

## Revenue Estimate Profile

### Coal Trust Interest

#### Distribution Chart:

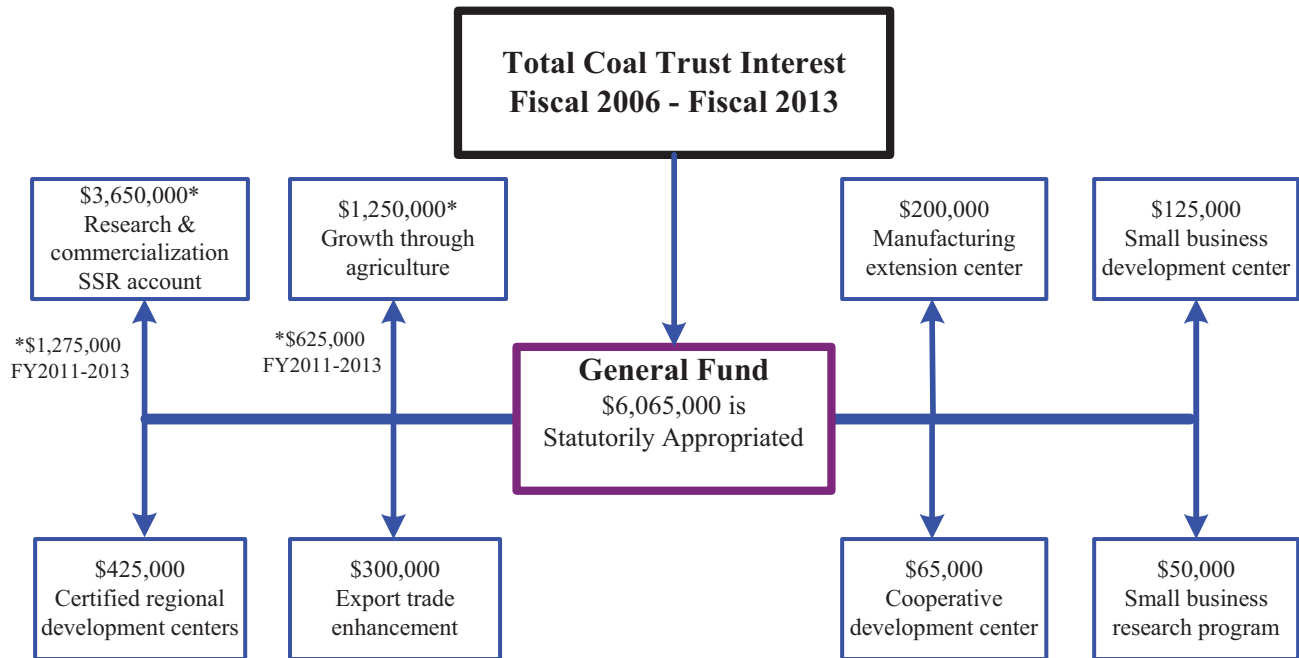

**Collection Frequency:** Monthly

#### **% of Total General Fund Revenue:**

FY 2004 – 2.53%	FY 2007 – 1.76%	FY 2010 – 1.65%
FY 2005 – 2.40%	FY 2008 – 1.47%	
FY 2006 – 1.82%	FY 2009 – 1.49%	

#### **Revenue Estimate Methodology:**

##### Data

The data used to estimate interest earnings from the coal trust are obtained from the Board of Investments (BOI), IHS, and the state accounting system (SABHRS). The BOI provides information on historic interest rates as well as the gains and losses from the sale of securities. Projections of future interest rates are provided by IHS and historic interest collections are obtained from SABHRS.

##### Analysis

The coal trust was created from distributions of the coal severance tax. While the Constitution requires that 50% of the coal severance tax collections be distributed into the coal trust, in early the 1990's the first sub-trust was created and two more were subsequently formed. Currently, the required coal tax revenue flows into the three sub-trusts and none of the tax revenue is deposited into the permanent coal trust. The principal or corpus of the coal trust (the portion that generates general fund interest) now stands at \$531.7 million.

To forecast the coal trust interest earnings, four interest/income components are estimated independently and summed. The interest/income components include:

- Trust funds bond pool (TFBP)
- In-state investments
- Short-term investment pool (STIP)
- Payback interest

# Legislative Fiscal Division

## Revenue Estimate Profile

### Coal Trust Interest

The TFBP was formed in 1995 to manage the fixed investments held in the state's major trust funds. Each trust owns "shares" of the pool and interest earnings are paid to each trust on a per-share basis. TFBP earnings are the largest source of earnings for the trust, as shown in the figure below. To estimate TFBP earnings, the base year (FY 2010) rate of return generated by the pool, as reported by the BOI, is adjusted during the forecast period for maturing securities. The applicable new long-term rate for these securities is based on an average of four long-term rates projected by IHS. The fiscal year long-term rate is expected to be 4.2% in FY 2011, 4.2% in FY 2012, and 5.0% for FY 2013.

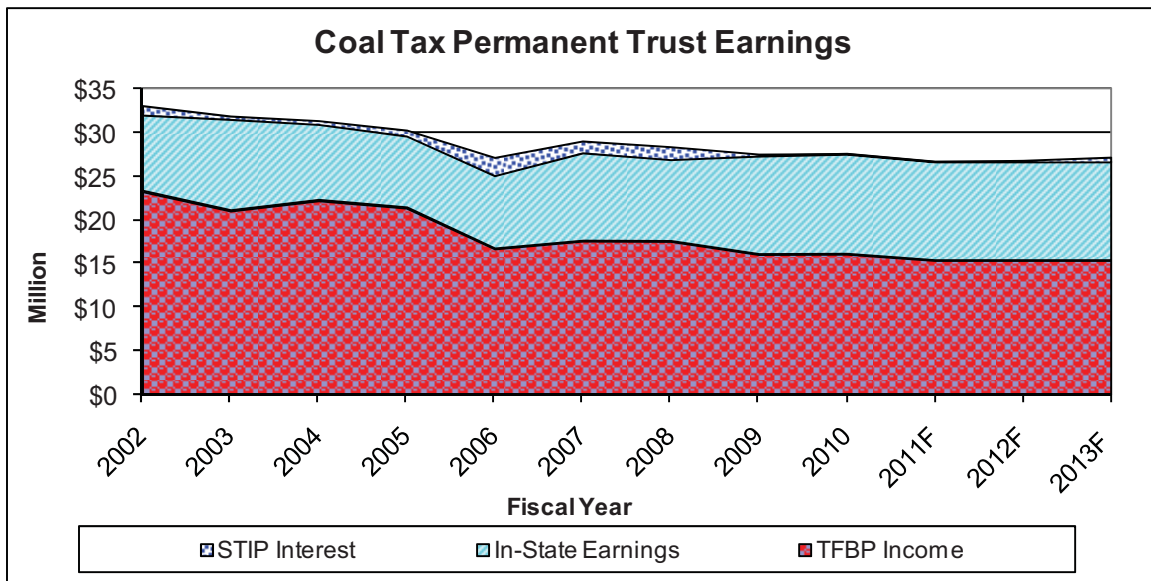

As seen in the figure above, earnings from in-state investments are the second largest source of income to the coal tax trust. The BOI is required by statute to invest 25% of the coal tax trust in the Montana economy. Investments must be made to maximize the long-term benefit to the Montana economy. In-state investments primarily consist of loans to Montana business entities and earnings are equal to the interest charged on the loans. The in-state balance is held constant throughout the biennium because no new flow of revenue is expected.

STIP interest (including other interest) is earned on cash, prior to investment in long-term investments. Funds are acquired from new deposits and/or maturing securities in the forecast period. Funds are held in STIP until the BOI determines that conditions are favorable for investment in the TFBP. To estimate future STIP earnings, an average short-term interest rate is developed based on IHS projections of three short-term investments. The average of these rates is then converted to a fiscal year basis. The average fiscal year short-term rate is expected to be 0.3% in FY 2011, 0.9% in FY 2012, and 2.5% in FY 2013.

Payback interest earnings result from a loan of \$46.4 million to the common school trust fund, approved in SB 495 during the 2003 session. Interest on the loan is required to equal the rate of return generated by the TFBP. Additional income is derived from payment of the loan principal. Principal repayments may be temporarily placed into STIP and earn interest until invested in the TFBP. Loan interest paid into the trust declines as the outstanding principal is repaid. Earnings on loan principal payments are projected by applying the TFBP long-term interest rate to the principal payments.

After the estimates are calculated, the projected earnings from the four sources are combined to reach total coal trust interest revenue, and the revenues are distributed as described above.

# Legislative Fiscal Division

## Revenue Estimate Profile

### Coal Trust Interest

#### Forecast Methodology:

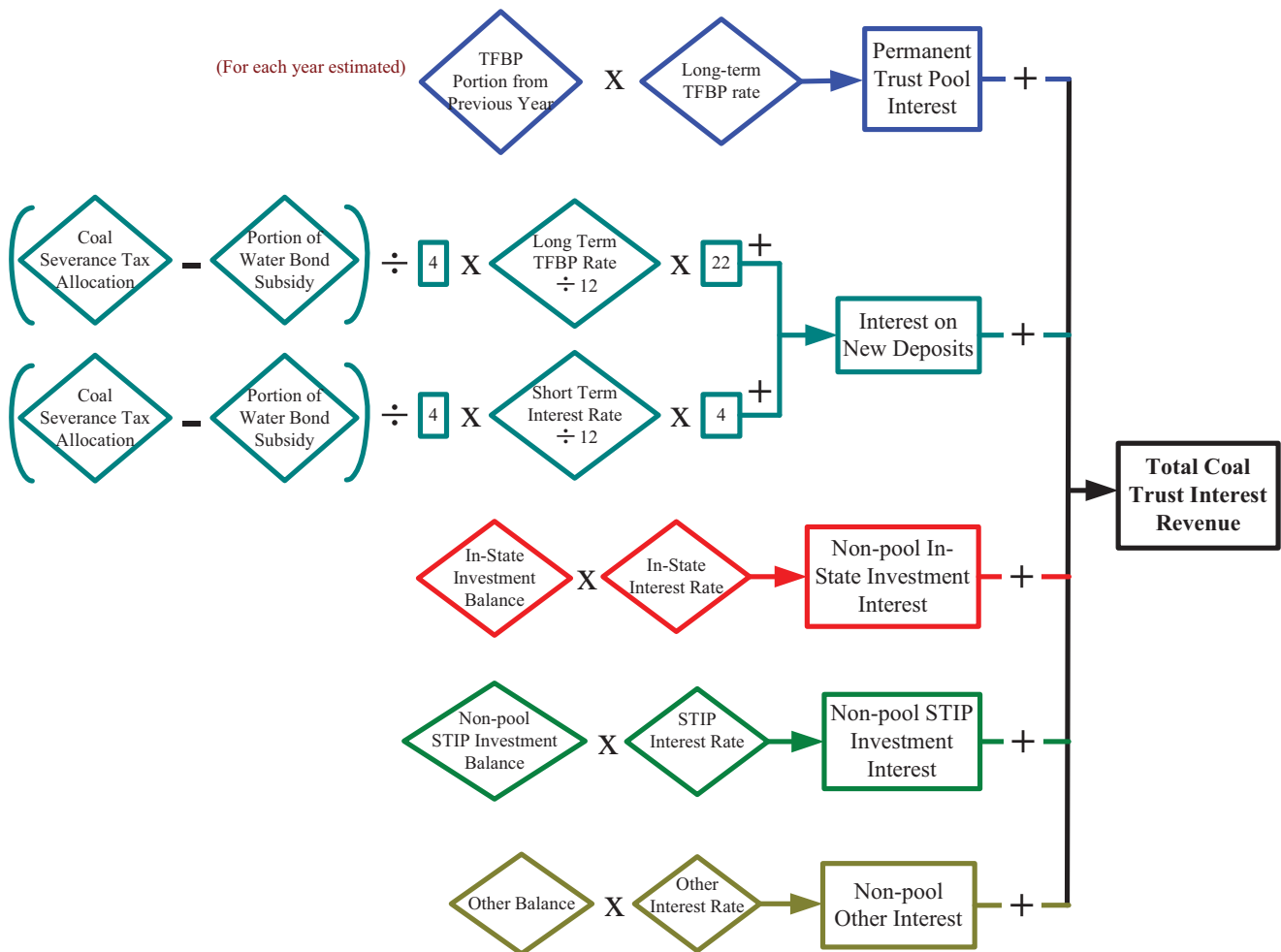

# Legislative Fiscal Division

## Revenue Estimate Profile

### Coal Trust Interest

#### Revenue Estimate Assumptions:

	t	Total Rev.	GF Rev.	TFBP	In_State	Other	STIP	Payback
	Fiscal	Millions	Millions	Interest	Interest	Interest	Interest	Interest
				Millions	Millions	Millions	Millions	Millions
Actual	2000	39.195203	39.195203					
Actual	2001	37.659527	37.659527					
Actual	2002	37.605247	37.605247	23.317933	8.764717	0.401582	1.096936	3.369611
Actual	2003	36.297863	36.297863	21.079491	10.501432	0.027838	0.388276	3.306650
Actual	2004	34.907273	34.907273	22.273639	8.721596	0.055237	0.451386	3.405415
Actual	2005	36.751940	36.751940	21.418762	8.231060	2.309776	0.691339	3.005668
Actual	2006	31.106170	31.106170	16.717821	8.337924	0.345783	2.116771	2.255822
Actual	2007	32.334879	32.334879	17.616328	10.084960	1.219784	1.377621	1.505159
Actual	2008	28.854611	28.854611	17.570357	9.346191	0.154346	1.500741	0.282977
Actual	2009	26.958378	26.958378	16.070820	11.263816	0.571585	0.228854	0.000000
Actual	2010	26.914102	26.914102	16.101896	11.454465	0.119258	0.059810	0.000000
Forecast	2011	26.512000	26.512000	15.378418	11.271090	0.106824	0.056784	0.000000
Forecast	2012	27.065000	27.065000	15.378418	11.271090	0.106818	0.193420	0.000000
Forecast	2013	27.418000	27.418000	15.378418	11.271090	0.106817	0.546544	0.000000

	t	Net Coal Tax	Bond	New Deposit	Non Pool	Non Pool	Non Pool	Gains
	Fiscal	New Deposit	Subsidy	Long Term	STIP	In State	Loan	Millions
		Millions	Millions	Rate	Rate	Rate	Rate	
Actual	2000	0.000000	0.193782	6.3380%	5.4290%	0.0000%	0.0000%	
Actual	2001	0.000000	0.480790	6.8850%	4.7390%	0.0000%	0.0000%	
Actual	2002	0.000000	0.264847	6.3380%	2.5650%	5.5888%	7.2673%	0.654469
Actual	2003	0.000000	0.780492	5.7290%	1.3600%	6.2141%	7.0000%	0.994175
Actual	2004	3.943085	1.473545	5.3650%	1.2650%	5.3526%	7.3445%	0.000000
Actual	2005	4.704314	1.294028	5.1940%	2.3870%	5.3648%	7.3445%	0.856503
Actual	2006	0.000000	0.417249	5.2340%	4.0770%	5.3524%	7.3445%	1.332049
Actual	2007	0.000000	0.000000	5.4050%	4.7290%	5.6001%	6.1505%	0.531027
Actual	2008	0.000000	0.000000	5.3180%	3.1650%	4.8981%	5.7249%	0.000000
Actual	2009	0.000000	0.802513	5.1210%	0.9770%	5.8729%	5.0505%	(0.380670)
Actual	2010	0.000000	0.084771	4.7440%	0.2120%	5.7819%	5.0966%	0.000000
Forecast	2011	0.000000	2.704075	4.2140%	0.2500%	5.7819%	4.7412%	0.000000
Forecast	2012	0.000000	1.042991	4.1590%	0.9150%	5.7819%	4.7412%	0.000000
Forecast	2013	0.000000	1.087353	5.0340%	2.5430%	5.7819%	4.7412%	0.000000

# Legislative Fiscal Division

## Revenue Estimate Profile

### Coal Trust Interest

	t	Non Pool STIP Bal	Non Pool In-State Bal	Non Pool Loan Bal	SB495 Loan Payment	Invested Balance	Average Return Rate	SB69 Impacts Millions
	<u>Fiscal</u>	<u>Millions</u>	<u>Millions</u>	<u>Millions</u>	<u>Millions</u>	<u>Millions</u>		<u>Millions</u>
Actual	2000	15.334577	127.567412	0.000000				
Actual	2001	22.784722	145.401756	0.000000				
Actual	2002	26.721811	168.249355	46.366904				
Actual	2003	37.107451	169.737929	46.366904				
Actual	2004	41.478106	156.145542	46.366904				
Actual	2005	48.813893	150.708090	44.546088	1.820816	552.184053	0.066125	
Actual	2006	50.509520	160.849807	41.896025	2.650063	541.169612	0.057480	
Actual	2007	33.158539	199.324095	31.047064	10.848961	548.455440	0.058956	
Actual	2008	15.910804	182.301654	11.573605	19.473459	538.681324	0.053565	
Actual	2009	20.175525	201.283659	0.000000	11.573605	528.973775	0.052468	(0.292050)
Actual	2010	17.744949	194.937480	0.000000	0.000000	537.039506	0.051645	(0.584100)
Forecast	2011	17.744949	194.937480	0.000000	0.000000	537.039506	0.049367	(0.301000)
Forecast	2012	17.744949	194.937480	0.000000	0.000000	537.039506	0.050396	0.115000
Forecast	2013	17.744949	194.937480	0.000000	0.000000	537.039506	0.051054	0.115000

Total Rev. = Invested Balance × Average Return

GF Rev. = Total Rev.

# Legislative Fiscal Division

## Revenue Estimate Profile

### Coal Trust Interest

#### Revenue Projection:

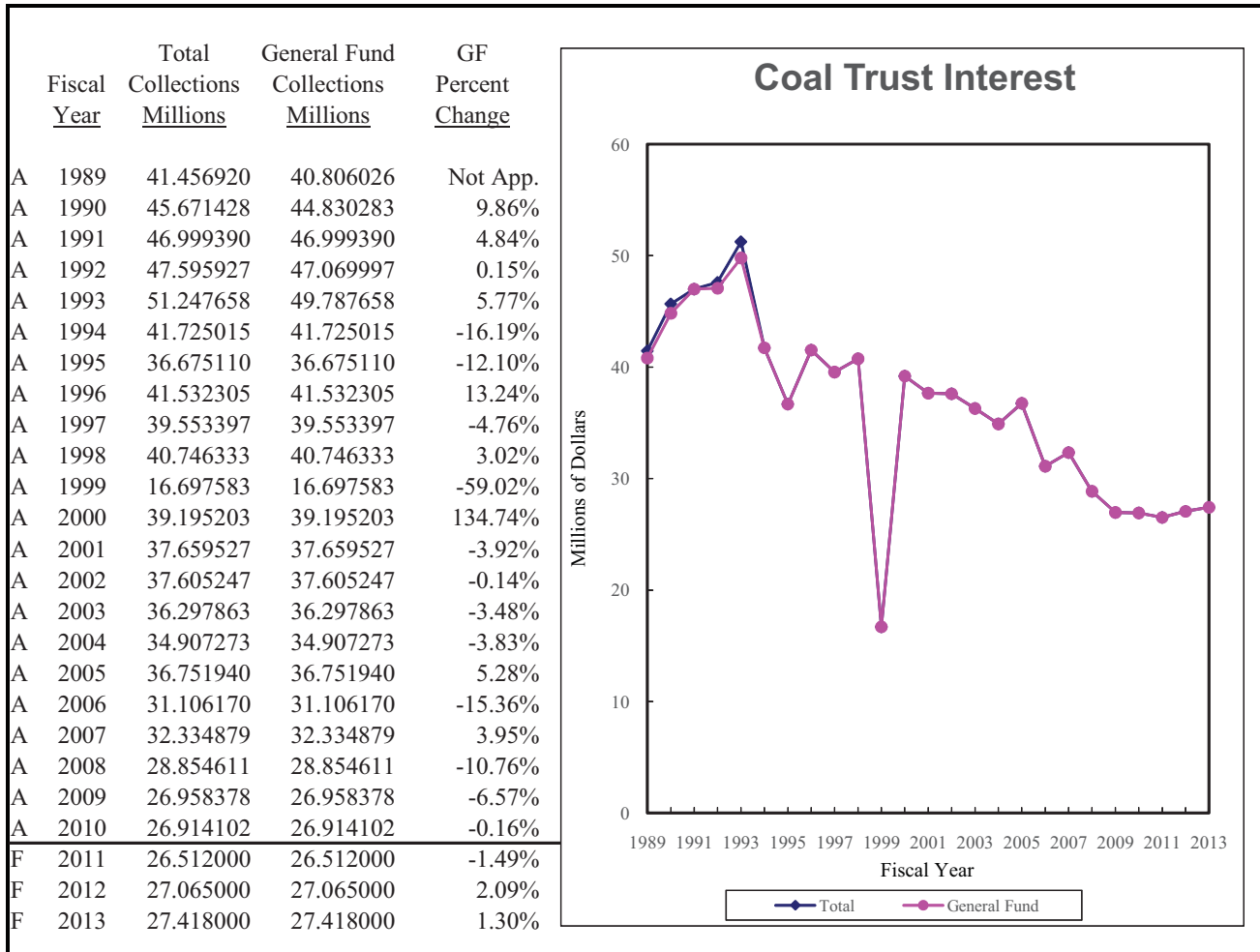

**Data Source(s):** Board of Investments, SABHRS, *Wall Street Journal*, IHS

**Contacts:** Board of Investments



---

# Legislative Fiscal Division

## Revenue Estimate Profile

### Common School Interest and Income

---

**Revenue Description:** Lands granted by the federal government to the state for the benefit of public schools generate income. The common school trust is actually part of the trust and legacy trust fund that includes nine other trusts. Prior to FY 1996, interest and income from the common school trust was deposited in the state equalization account. Beginning in FY 1996, this interest and income was deposited in the general fund, as mandated by SB 83, passed by the 1995 Legislature. Beginning FY 2003, House Bill 7 from the August 2002 special legislative session changed the deposit to the state special revenue guarantee account and statutorily appropriated the money for schools. The estimates show the amount of revenue deposited to the guarantee account and are net of amounts diverted for DNRC administration costs and those deposited directly to the school facility and technology account. With the enactment of Senate Bill 65 by the 2009 Legislature, diverted revenue can be derived from: 1) distributable revenue; 2) sale of easements; 3) timber, except from public school and Montana university system lands; 4) mineral royalties; and 5) fees from sales of state lands except lands granted by the Morrill Act. The amount of the permanent revenue (mineral royalties and easements) diverted from the common school trust reduces the growth of the trust fund balance and, hence, reduces the amount of future distributable interest earnings.

With the enactment of HB 152 by the 2009 Legislature, revenue from the value of timber over 18 million board feet and revenue from power site rents are no longer deposited to the guarantee account, but are deposited to the school facility and technology account. Mineral royalty revenue required to pay interest and principal on the SB 495 loan is not included since the loan was repaid in FY 2008. All net (excluding amounts for administration) mineral royalty revenue is deposited to the guarantee account for transfer to the school facility and technology account. These items are explained below.

Common school lands produce two kinds of revenue: 1) distributable income such as interest earnings, agricultural rents or crop shares, and timber sale revenue; and 2) permanent income that is returned to the trust such as income from the sale of minerals (see the effects of Senate Bill 495 from the 2003 legislative session below), land, and easements. Excluding the amount of revenue diverted for DNRC administration (Senate Bill 65 enacted by the 2009 Legislature) and to the school facility and technology account (House Bill 152 enacted by the 2009 Legislature), 95% of certain distributable revenue is available to fund public schools. Timber revenue is allocated: 1) 5% to the permanent school trust; 2) revenue received from production over 18 million board feet is deposited to the school facility and technology account; and 3) any remainder to the guarantee account for the support of public schools.

As of October 1, 1995, all fixed-income investments held by the state's major trust funds (which include the trust and legacy fund of which the common school trust is a part), were transferred to a newly-created Trust Funds Bond Pool (TFBP). The majority of common school trust funds are invested as part of the TFBP. Some funds, however, are invested on a short-term basis in the state's Short Term Investment Pool (STIP). The state Constitution prohibits the investment of common school trust funds in common stock. Interest income is distributed 95% to the guarantee account and 5% to the trust.

Senate Bill 495 (enacted by the 2001 Legislature) authorized DNRC to purchase the mineral production rights (with a loan from the coal severance trust) from the common school trust. The department subsequently purchased \$138.9 million of net future mineral royalties from the school trust for \$46.4 million. Since these royalties will no longer be deposited to the trust, interest earnings from the trust corpus are lessened. It is estimated that the trust balance will be at least \$92.5 million less after all the \$138.9 million has been distributed. The net mineral royalties are first used to pay the principal and interest of the \$46.4 million loan with the remainder deposited to the guarantee account to fund base aid. Since the loan was paid off in FY 2008, SB 2 (May 2007 special session) directs that all net mineral royalties (until the total amount of \$138.9 million that was purchased is received) are to be deposited to the guarantee account and then transferred to the school facility improvement account (changed to the facility and technology account in HB 152 enacted by the 2009 Legislature). The amount of \$138.9 million in net mineral royalties was achieved at the end of FY 2010. After FY 2010, all mineral royalties (except those diverted for administration costs under SB 65 enacted by the 2009 Legislature) will be deposited to the permanent school trust fund. For further information and analysis on Senate Bill 495 contact the Legislative Fiscal Division for a copy of the two-part report: "Senate Bill 495-Implementation, Impacts and Implications".

---

# Legislative Fiscal Division

## Revenue Estimate Profile

### Common School Interest and Income

---

#### Statutory Reference:

Tax Rate – NA

Distribution (MCA) – Montana Constitution Article X, Section 5; 20-9-342 (school technology); 20-9-622 (guarantee account)

Enabling Act, Section 10

Other (MCA) – DNRC trust land administration diversion (77-1-108 & 77-1-109)

DNRC land bank administration diversion (77-2-362)

Date Due - the last business day of February following the calendar year in which the money was received (20-9-342).

**Applicable Tax Rate(s):** N/A

**Distribution:** As described above, 95% of interest and income from common school permanent trust fund (excluding a portion of timber sale revenue and after amounts diverted for DNRC administration) is distributed to the state special revenue guarantee account and is statutorily appropriated for schools. The remaining 5% is deposited to the permanent trust fund. The amount of timber sale revenue over 18 million board feet is deposited to the school facility and technology account. Up until the total of \$138.9 million of purchased royalties was reached, the portion of mineral royalties not used for DNRC administration was deposited to the guarantee account and, with the enactment of SB 2 (May 2007 special session), transferred to the school facility and technology account (renamed in HB 152 enacted by the 2009 Legislature). Since the \$138.9 million was reached late in FY 2010, mineral royalties will again be deposited to the common school permanent trust fund and will generate additional distributable income. The amounts deposited to the guarantee account are shown in this revenue source.

#### Distribution Chart:

**State Special Revenue Fund**

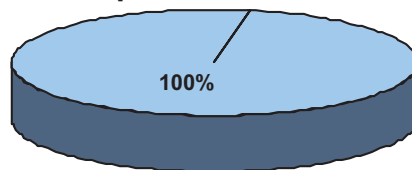

**Collection Frequency:** Revenue is received monthly. However, distribution to the state special revenue fund takes place three times per year.

**% of Total General Fund Revenue:** N/A

#### **Revenue Estimate Methodology:**

The estimate for interest and income from the common school trust determines the net amount of revenue that will be deposited to the guarantee account. This means that in addition to estimating the various revenues from the common school trust, estimates of the diversions for DNRC administration costs that reduce the amount of revenue deposited to the guarantee account must also be estimated. Therefore, the estimated amounts shown for this revenue source are not total revenues, but are net of diversions.

#### Data

Data from the state accounting system (SABHRS) provide a history of each individual interest and income revenue component from which estimates can be made. Department of Natural Resources and Conservation (DNRC) annual reports provide additional information such as mineral prices and production. Budget submissions on the state budgeting system (MBARS) provide anticipated amount of diversions. DNRC personnel are contacted for their views on potential future factors that may influence revenues such as easement sales, changes in grazing and agricultural rentals, and timber harvest volumes. IHS provides future estimates of West Texas Intermediate oil and national well head natural gas prices.

# Legislative Fiscal Division

## Revenue Estimate Profile

### Common School Interest and Income

#### Analysis

The estimate is derived by first estimating the revenue components and then estimating the amounts of the diversions.

#### Revenue Components

1. Agricultural Fees – Fees are based on a crop share basis. Commodity prices are expected to be about the same as FY 2010 resulting in similar returns.
2. Timber – Estimates of timber harvest revenue from common school trust lands are taken directly from DNRC estimates provided in October 2010.
3. Oil & Gas Bonuses – With record highs in energy prices, competition to obtain mineral leases has increased, resulting in large bonus payments. A single large one-time bonus payment of \$10.6 million has already been received in FY 2009. All years contain a base amount of \$2.2 million that was received in FY 2008.

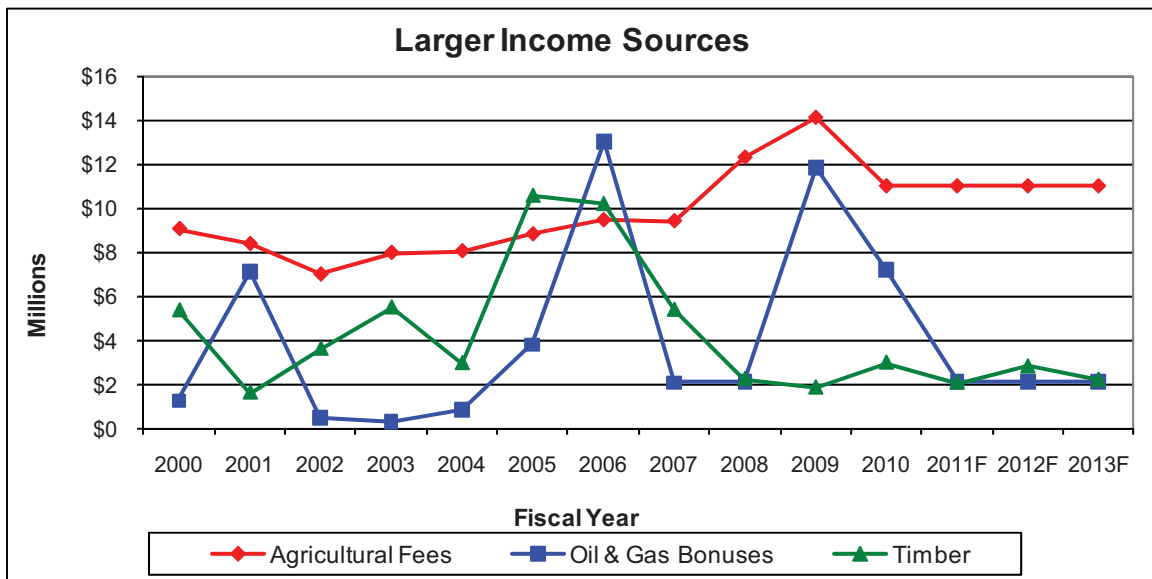

4. Grazing Fees – Rates are tied to the price of cattle. Cattle prices are expected to be close to those experienced in FY 2010, perhaps slightly less. DNRC personnel anticipate the grazing fee revenue will be similar to FY 2010.
5. Oil & Gas Leases – For each fiscal year estimated, an average annual growth rate over the previous eight year period was applied beginning with FY 2010 collections.
6. Oil & Gas Penalties – For each fiscal year estimated, the ratio of the previous year’s penalties to the previous year’s oil and gas lease revenue was multiplied by that year’s estimate for oil and gas lease revenue.
7. Miscellaneous Rentals – The estimate involves two parts: a) in FY 2010, Arch Coal signed an agreement to pay for the mineral rights to Otter Creek Coal, of which \$81.5 million was deposited to the guarantee account; and b) the remaining small income base components are estimated together by using an average annual growth rate over the previous two year period beginning with FY 2010 collections, excluding the Otter Creek payment.
8. Short-term Investment Pool (STIP) – Because revenue initially deposited in the common school trust is invested on a short-term basis (about one month) before being invested in the T & L fund, a short-term rate is used to calculate the earnings. The short-term rate is a composite of IHS forecasts for the 3-month commercial paper, 3-month treasury bill, and 6-month treasury bill rates and is estimated to be 0.3% in FY 2011, 0.9% in FY 2012, and 2.5% in FY 2013.

# Legislative Fiscal Division

## Revenue Estimate Profile

### Common School Interest and Income

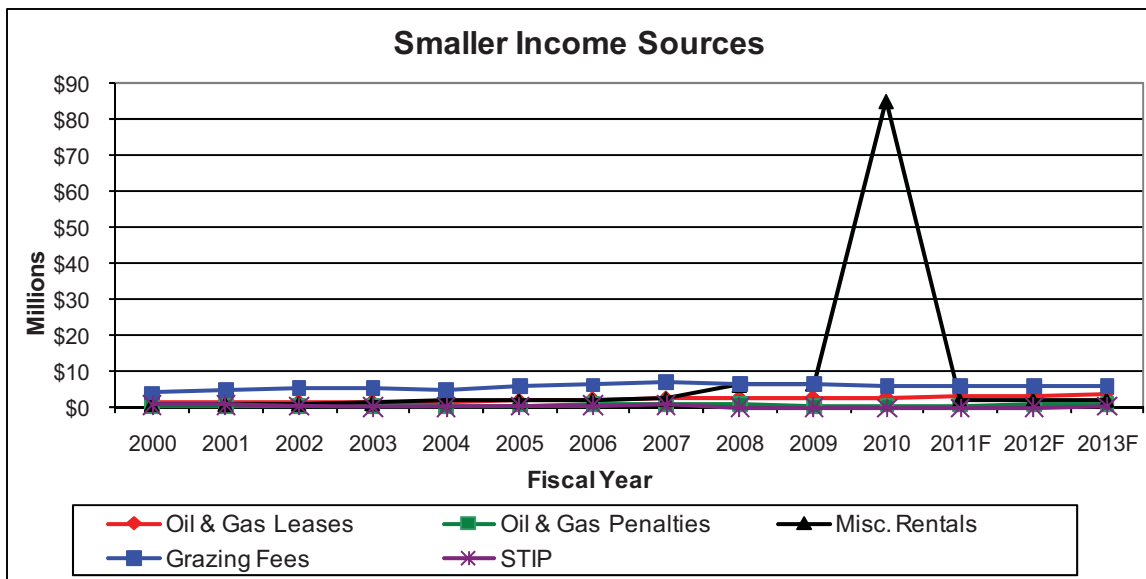

9. Mineral Royalties – Mineral royalties are received from the mining of oil, natural gas, coal, sand and gravel, and other smaller sources. Since the effects of SB 495 (enacted by the 2001 legislature effective FY 2002) ended late in FY 2010, mineral royalties will again be deposited to the common school trust and will become part of the trust corpus. The additional corpus will generate additional earnings. The figure below shows total mineral royalties since FY 2002. The estimate for mineral royalties is obtained by multiplying together estimates for production, price, and the applicable royalty rate.

- Production – Oil and natural gas production is estimated by increasing the previous fiscal year’s production by the growth rate obtained from a two-year average of the estimates for statewide oil and natural gas production (see the Oil and Natural Gas Production Tax profile). Coal production on state lands comes primarily from a single coal company with minor amounts from another company. Calendar year information on projected production and percentage of production on state lands was obtained by surveying coal companies, including the companies producing on state lands, from which the amount of production on state lands is derived. Fiscal year production is obtained by averaging production for the current and previous calendar years. All other mineral production was held constant at the amount of gravel royalty collection in FY 2010.
- Price – Oil prices are calculated by increasing the previous year’s Montana price by the growth between the average West Texas Intermediate price estimates obtained from IHS for the four quarters of the same fiscal years. The same methodology is used for natural gas with the driving factor being the IHS estimated national well head price. Coal price is determined by increasing the previous fiscal year’s price by a growth rate obtained from a two-year average of the calendar year estimates for Montana coal prices (see the Coal Severance Tax profile).

10. Trust and Legacy Earnings – The monetary assets of the common school trust are pooled with monetary assets of other land trusts (termed “Trust and Legacy”) and invested by the Board of Investment in the trust funds bond pool. Based on the number of share each trust owns, a share of the earnings is deposited in each trust. For the common school trust, the actual FY 2008 share of 92.64% is used. The pool balance grows when permanent revenue is deposited from the various land trust, including the common school trust. DNRC personnel state that no substantial sales of right-of-ways (a source of permanent revenue) are anticipated in the three fiscal years. However, due to the ending of SB 495 in FY 2010, mineral royalties (permanent revenue) will once again add to the balance. The estimation of the total pool earnings is a three stage process:

- Earnings from new deposits – New deposits in the pool are estimated to be in \$22.0 million in FY 2011, \$20.5 million in FY 2012 and \$22.1 million in FY 2013. This additional money initially earns interest at the short-term rate (0.3% in FY 2011, 0.9% in FY 2012, and 2.5% in FY 2013) before it is invested in a longer term investment (4.2% in FY 2011, 4.2% in FY 2012, and 5.0% in FY 2013). Also included in these calculations are short-term earnings from the estimated \$4.1 million average balance in the common school Land Bank Trust Fund.
- Earnings from existing balance – The pool balance in FY 2010 was \$444.7 million. The majority of these funds have been invested in bonds purchased over the past several year and average a return rate of 5.2%.

# Legislative Fiscal Division

## Revenue Estimate Profile

### Common School Interest and Income

- Non-portfolio earnings – Money not invested in the trust funds bond pool earns interest at the short-term rate of 0.3% in FY 2009, 0.9% in FY 2010, and 2.5% in FY 2011 on a balance of \$11.3 million, the actual balance from FY 2010.

Once the total amount of the pool earnings has been estimated by summing the above three items, the common school share of 92.64% is applied.

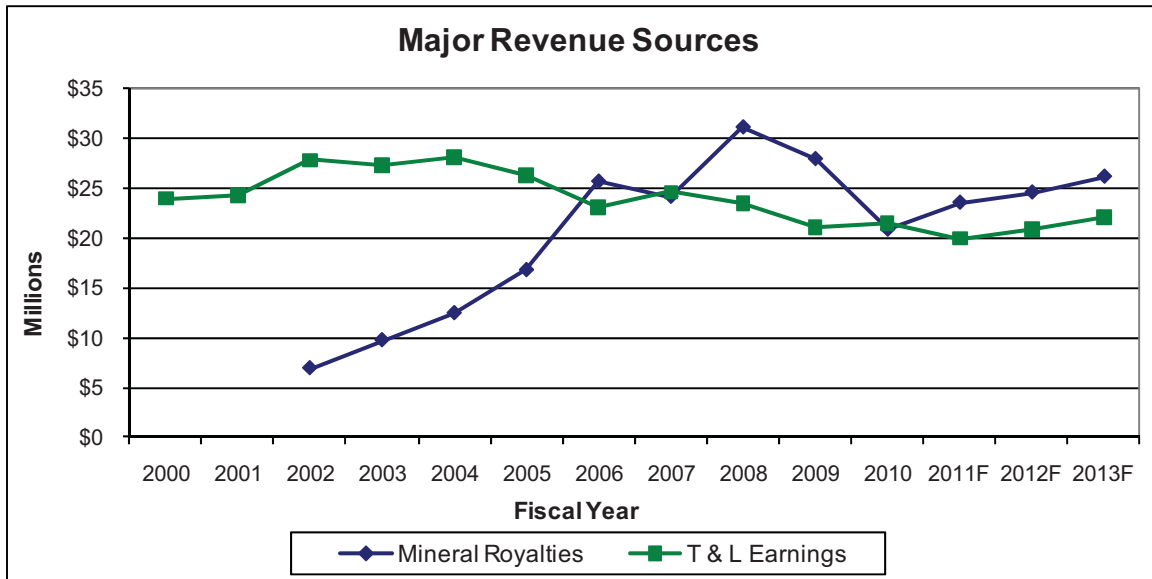

#### Diversions

Diversions fund operational costs in DNRC, but reduce the amount of permanent revenue deposited to the common school trust and revenue distributed to the trust beneficiaries (see the figure below). To determine future diversion amounts, DNRC's present law budget amounts are used.

- Trust Land Administration Account – Of the total expenditures requested to be made from this account, a portion is funded by the trust's distributable revenue. That portion is determined by multiplying current year revenue estimates by the ratio of FY 2010 costs that this trust paid to the total administration costs. In FY 2010, the common school trust funded 3.6% of total expenditures. A portion of mineral royalties and other permanent income can also be diverted to this account to fund department's activities in managing the common school trust lands. The portion of permanent revenue was determined by discussions with DNRC staff.

# Legislative Fiscal Division

## Revenue Estimate Profile

### Common School Interest and Income

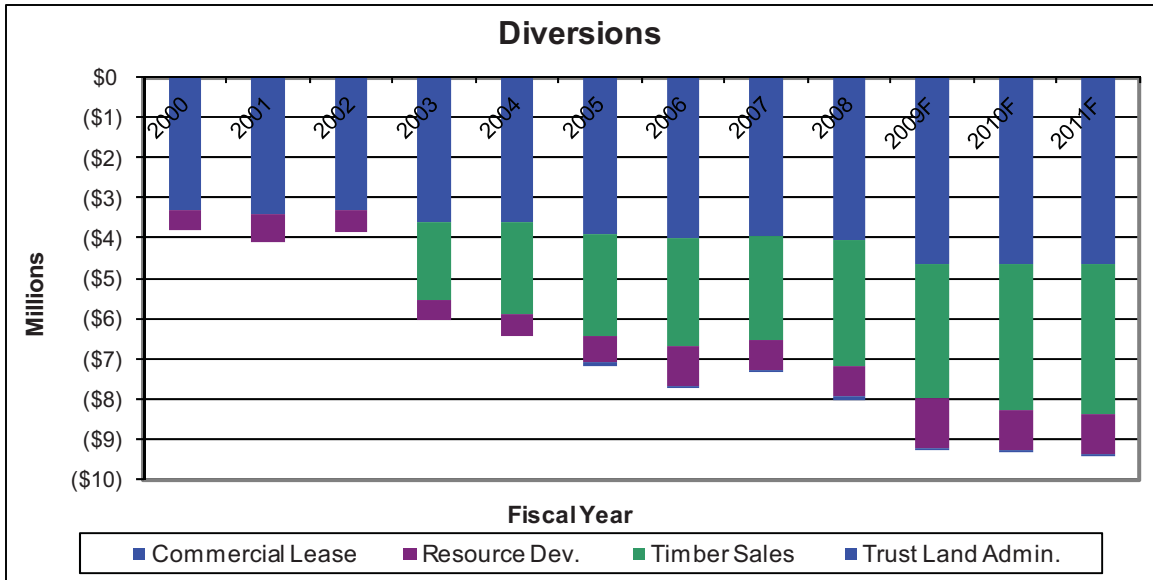

#### Adjustments and Distribution

Once total revenue and total diversions have been estimated, the amounts are distributed:

- 95% of the distributable interest and income (excluding a portion of timber revenue) net of diversions is deposited to the guarantee account and the remaining 5% is returned to the permanent trust fund. The money deposited to the guarantee account is used for public schools.
- The value received from timber sales over 18 million board feet is distributed to the school facility and technology account to fund school technology. The amount of money distributed to the account in one year is spent in the next year.
- Mineral royalties are used to fund a portion of administrative costs with the remainder distributed to the school permanent trust fund.

# Legislative Fiscal Division

## Revenue Estimate Profile

### Common School Interest and Income

**Forecast Methodology:**

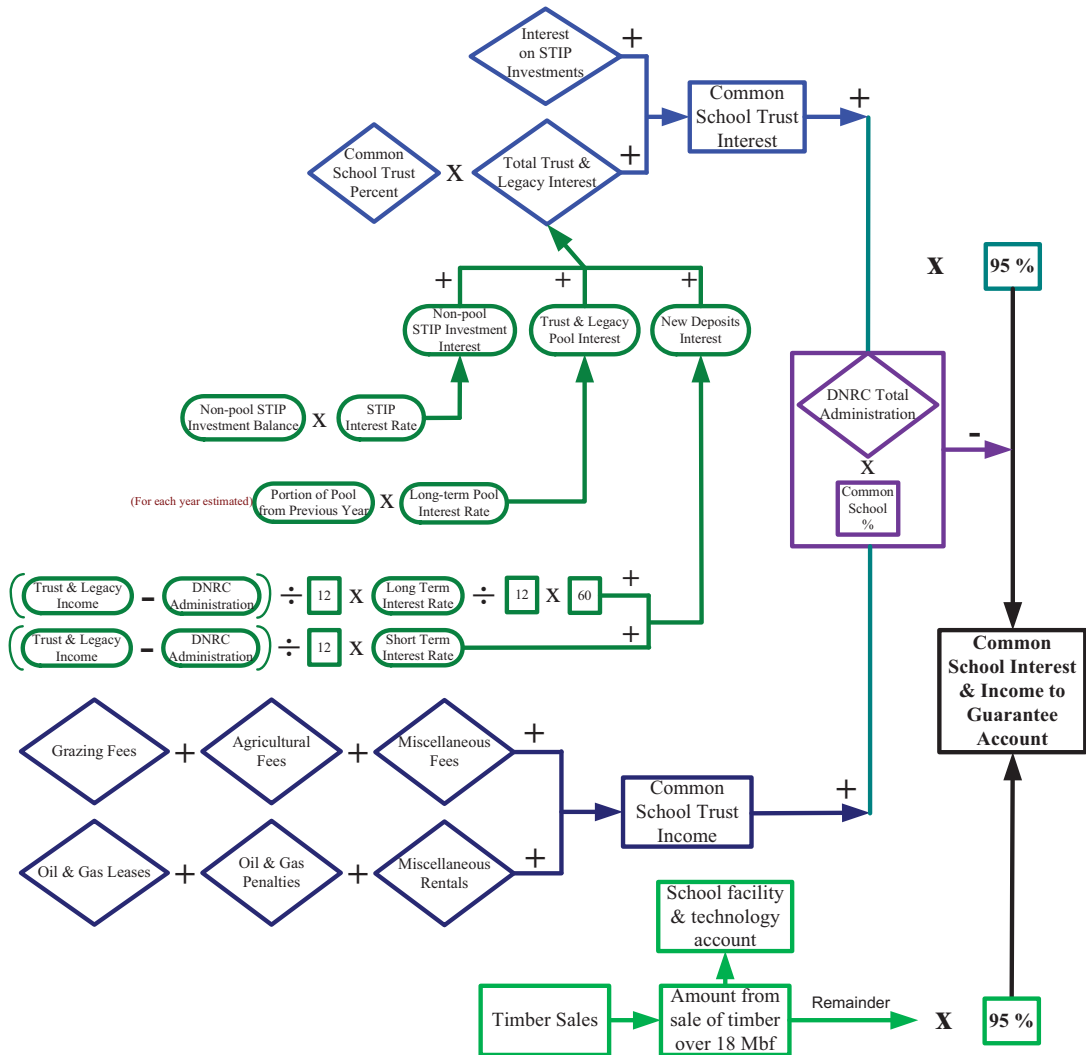

**Legislative Fiscal Division**  
**Revenue Estimate Profile**  
**Common School Interest and Income**

**Revenue Estimate Assumptions:**

	t	Total Rev.	GF Rev.	TFBP	STIP	Common	SB495	Trust Land
	Fiscal	Millions	Millions	Interest	Interest	School Share	Loan Pay.	Expense
				Millions	Millions	T&L	Millions	Millions
Actual	2000	44.296034	44.296034			0.938562		
Actual	2001	46.845895	46.845895			0.923235		
Actual	2002	50.875186	48.937673	29.627056	0.102664	0.932906		
Actual	2003	48.977342	0.000000	29.146744	0.068370	0.931091	0.000000	-3.551119
Actual	2004	55.663022	0.000000	30.087011	0.053502	0.928698	-1.820816	-3.311911
Actual	2005	68.035764	0.000000	28.106281	0.269698	0.927050	-2.650063	-3.679601
Actual	2006	82.605539	0.000000	24.428206	0.408162	0.928000	-10.848961	-3.904704
Actual	2007	70.428669	0.000000	26.206838	0.267652	0.926977	-19.473459	-3.130197
Actual	2008	83.025650	0.000000	25.159580	0.128925	0.926420	-11.573605	-3.808804
Actual	2009	61.820945	0.000000	22.711371	0.066450	0.926420	0.000000	-9.943097
Actual	2010	133.315478	0.000000	22.916114	0.018370	0.926420	0.000000	-8.674316
Forecast	2011	46.987000	0.000000	21.081910	0.036287	0.926420	0.000000	-5.689279
Forecast	2012	44.907000	0.000000	21.840294	0.123603	0.926420	0.000000	-5.761113
Forecast	2013	45.906000	0.000000	22.527557	0.349263	0.926420	0.000000	-5.800281

	t	Trust Income	New Deposit	Non Pool	Non Pool	SB495
	Fiscal	New Deposit	Long Term	STIP	STIP Bal	Interest
		Millions	Rate	Rate	Millions	Millions
Actual	2000	10.969295	7.0160%	5.4290%	11.676486	
Actual	2001	12.667780	6.8850%	4.7390%	6.984553	
Actual	2002	2.348339	6.3380%	2.5650%	7.334239	
Actual	2003	2.363355	5.7290%	1.3600%	6.242273	
Actual	2004	2.971526	5.3650%	1.2650%	7.049634	
Actual	2005	1.457756	5.1940%	2.3870%	12.106697	-3.005668
Actual	2006	1.425106	5.2340%	4.0770%	3.862666	-2.255822
Actual	2007	7.173844	5.4050%	4.7290%	14.953757	-1.505159
Actual	2008	3.101654	5.3180%	3.1650%	2.461097	-0.282977
Actual	2009	4.125990	5.1210%	0.9770%	4.161322	0.000000
Actual	2010	10.709883	4.7440%	0.2120%	11.339709	0.000000
Forecast	2011	17.996772	4.2140%	0.2500%	11.339709	0.000000
Forecast	2012	16.524718	4.1590%	0.9150%	11.339709	0.000000
Forecast	2013	19.408102	5.0340%	2.5430%	11.339709	0.000000



**Legislative Fiscal Division**  
**Revenue Estimate Profile**  
**Common School Interest and Income**

	<u>t</u> <u>Fiscal</u>	<u>Grazing</u> <u>Millions</u>	<u>Agriculture</u> <u>Millions</u>	<u>Misc.</u> <u>Millions</u>	<u>O&amp;G Lease</u> <u>Millions</u>	<u>O&amp;G Bonus</u> <u>Millions</u>	<u>O&amp;G Penalty</u> <u>Millions</u>	<u>Misc.</u> <u>Millions</u>
Actual	2000	4.065911	9.053155	0.000000	1.328220	1.277231	0.261334	1.127779
Actual	2001	4.850839	8.376539	0.000000	1.448285	7.118093	0.355322	1.121433
Actual	2002	5.467322	6.998644	0.000000	1.540472	0.478224	0.334699	1.243778
Actual	2003	5.243241	7.974945	0.000000	1.575356	0.300943	0.399347	1.348894
Actual	2004	4.970961	8.051131	0.000000	1.648808	0.870693	0.533758	2.156382
Actual	2005	5.918241	8.816342	0.000000	1.893296	3.826961	0.640759	2.057478
Actual	2006	6.276945	9.453271	0.000000	2.330531	13.005123	0.864068	2.193452
Actual	2007	7.057412	9.408029	0.000000	2.506340	2.101872	1.066758	2.510437
Actual	2008	6.407660	12.282064	0.000000	2.700962	2.153575	0.812454	6.417877
Actual	2009	6.469505	14.081222	0.000000	2.760133	11.828143	0.540592	6.794884
Actual	2010	5.860916	10.984709	0.000000	2.873398	7.243030	0.614581	85.246735
Forecast	2011	5.860916	10.984709	0.000000	3.131006	2.127724	0.669680	2.357254
Forecast	2012	5.860916	10.984709	0.000000	3.431402	2.127724	0.733931	2.357254
Forecast	2013	5.860916	10.984709	0.000000	3.735639	2.127724	0.799003	2.357254

	<u>t</u> <u>Fiscal</u>	<u>Int. Land</u> <u>Millions</u>	<u>Int. STIP</u> <u>Millions</u>	<u>Int. Trust</u> <u>Millions</u>	<u>Timber</u> <u>Millions</u>	<u>Res. Dev.</u> <u>Millions</u>	<u>Commercial</u> <u>Lease</u> <u>Millions</u>
Actual	2000	0.000566	0.706653	23.905761	5.379555	-0.513416	
Actual	2001	0.000290	0.715090	24.206450	1.623592	-0.698124	
Actual	2002	0.000063	0.305319	27.775111	3.624785	-0.504023	
Actual	2003	0.019744	0.188794	27.201941	3.605510	-0.499362	
Actual	2004	0.002900	0.199526	27.991422	0.666749	-0.517845	
Actual	2005	0.025797	0.408384	26.305944	3.651789	-0.686492	-0.067175
Actual	2006	0.000000	0.641609	23.048141	2.878508	-1.003369	-0.067975
Actual	2007	0.000000	0.733359	24.541243	1.929315	-0.722384	-0.057113
Actual	2008	0.000000	0.605693	23.427775	2.250670	-0.785520	-0.057002
Actual	2009	0.000000	0.293474	21.093503	1.855345	-1.129406	-0.096177
Actual	2010	0.000000	0.063112	21.369578	2.990090	0.000000	0.000000
Forecast	2011	0.000000	0.051650	19.926373	2.077324	0.000000	0.000000
Forecast	2012	0.000000	0.189821	20.847955	2.814555	0.000000	0.000000
Forecast	2013	0.000000	0.536890	21.976794	2.208823	0.000000	0.000000

**Legislative Fiscal Division**  
**Revenue Estimate Profile**  
**Common School Interest and Income**

	<u>t</u>	<u>Total</u>	<u>Timber</u>	<u>School</u>	<u>Oil</u>	<u>Gas</u>	<u>Coal</u>	<u>Other</u>
	<u>Fiscal</u>	<u>Timber</u>	<u>Sales Pgm.</u>	<u>Technology</u>	<u>Royalties</u>	<u>Royalties</u>	<u>Royalties</u>	<u>Royalties</u>
		<u>Millions</u>	<u>Millions</u>	<u>Millions</u>	<u>Millions</u>	<u>Millions</u>	<u>Millions</u>	<u>Millions</u>
Actual	2000	5.379555	0.000000	0.000000				
Actual	2001	1.623592	0.000000	0.000000				
Actual	2002	3.624785	0.000000	1.822162	2.390492	1.523062	2.836919	0.144369
Actual	2003	5.507588	-1.829039	0.000000	3.681611	1.995499	3.877054	0.148393
Actual	2004	2.968369	-1.940581	3.178988	4.851597	2.718035	4.676964	0.169754
Actual	2005	10.602272	-2.536323	4.414160	7.965516	4.329847	4.239865	0.194346
Actual	2006	10.227233	-2.707337	4.641388	14.759265	6.317280	4.179503	0.355698
Actual	2007	5.397993	-2.572832	0.895846	15.133322	5.082713	3.729473	0.147955
Actual	2008	7.316574	-3.117074	1.948830	19.366955	5.659708	5.865071	0.156243
Actual	2009	5.457205	-2.900512	0.701348	14.808525	4.737685	7.840866	0.485378
Actual	2010	5.380933	0.000000	2.390843	12.477971	2.841133	4.984163	0.488489
Forecast	2011	4.877324	0.000000	2.800000	11.903639	2.902061	8.553590	0.137482
Forecast	2012	5.314555	0.000000	2.500000	11.739571	3.196504	9.451161	0.137482
Forecast	2013	3.608823	0.000000	1.400000	10.910898	3.861479	11.196997	0.137482

	<u>t</u>	<u>Oil</u>	<u>Gas</u>	<u>Coal</u>	<u>Oil</u>	<u>Gas</u>	<u>Coal</u>	<u>Excess</u>
	<u>Fiscal</u>	<u>Production</u>	<u>Production</u>	<u>Production</u>	<u>Price</u>	<u>Price</u>	<u>Price</u>	<u>Royalties</u>
		<u>Barrels</u>	<u>MCF's</u>	<u>Tons</u>	<u>\$/Barrel</u>	<u>\$/MCF</u>	<u>\$/Ton</u>	<u>To Trust</u>
Actual	2000	0.923777	5.050552	3.273552	22.670000	1.880000	11.650000	
Actual	2001	0.889786	6.294741	2.252935	26.470000	3.930000	12.000000	
Actual	2002	0.911057	5.892287	2.758351	20.320000	1.910000	11.800000	
Actual	2003	1.017463	5.380950	3.689490	28.140000	3.200000	9.590000	
Actual	2004	1.122987	5.720200	4.183187	31.020000	3.950000	8.600000	
Actual	2005	1.400063	7.240046	3.914410	44.690000	5.090000	9.120000	
Actual	2006	2.024282	7.878173	4.212862	57.240000	6.640000	8.630000	
Actual	2007	2.012340	7.708192	3.006455	55.850000	5.130000	9.550000	
Actual	2008	1.808692	7.751961	4.720487	88.870000	6.120000	10.870000	
Actual	2009	1.661685	6.710328	5.603917	60.160000	4.660000	11.970000	-5.542068
Actual	2010	1.571187	5.306417	2.679543	60.740000	3.360000	12.090000	-1.398232
Forecast	2011	1.436031	5.506042	4.347000	63.342097	3.178596	12.789478	19.496772
Forecast	2012	1.284320	5.366220	4.625000	69.848241	3.592321	13.282122	20.524718
Forecast	2013	1.132609	5.226398	5.942500	73.613418	4.455737	12.246907	22.106856

Total Rev. = (Grazing + Agriculture + O&G Lease + O&G Bonus + O&G Penalty + Misc. + Int. Land + Int. Stip + Int. Trust + Timber + Res. Dev. + Commercial Lease) × .95 + Oil Roy. + Gas Roy + Coal Roy. + Other Roy. + School Technology + Trust Land Admin. - Excess Royalties To Trust

# Legislative Fiscal Division

## Revenue Estimate Profile

### Common School Interest and Income

**Revenue Projection:**

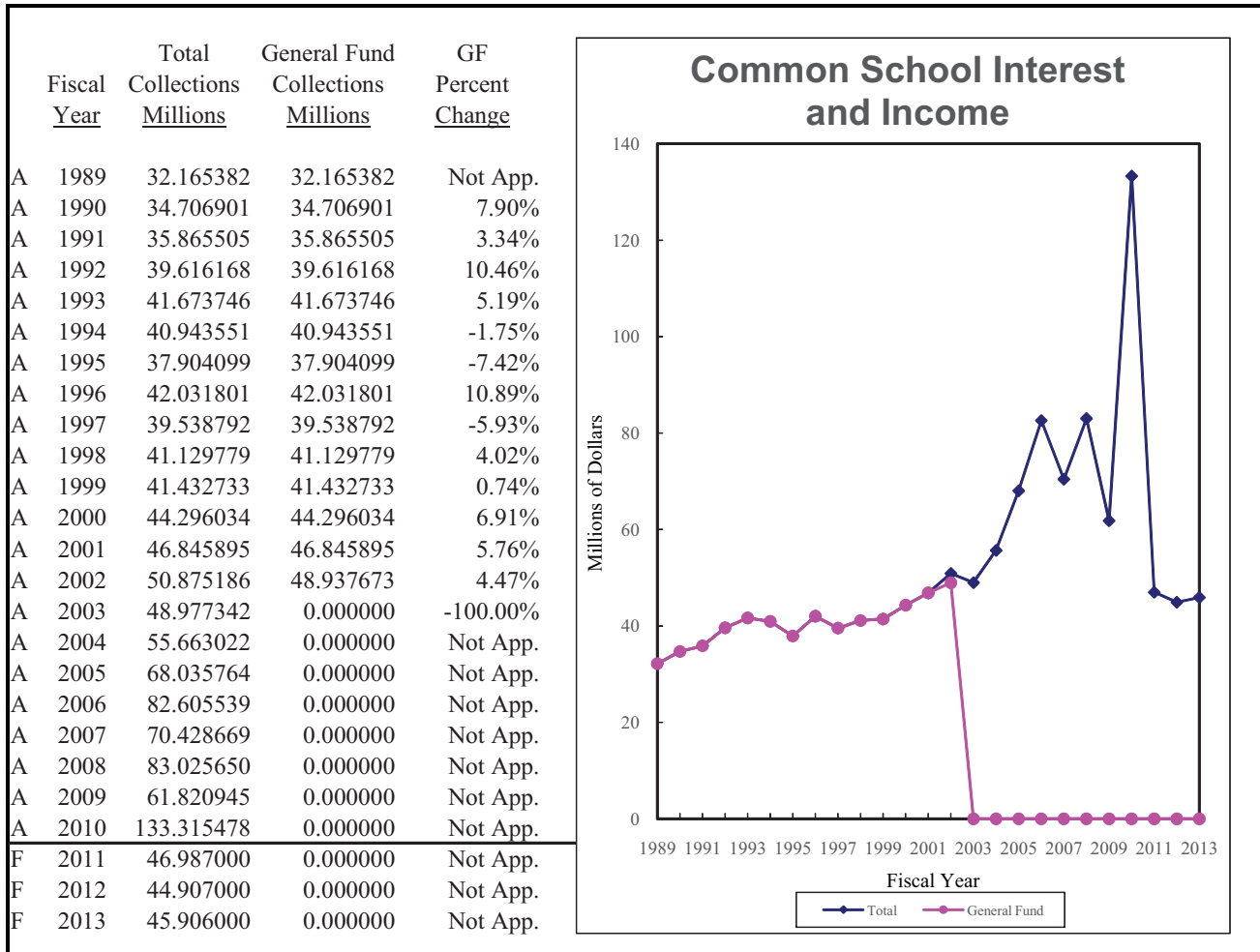

**Data Source(s):** Board of Investments, DNRC - Centralized Services, SABHRS, *Wall Street Journal*, IHS

**Contacts:** Department of Natural Resources and Conservation

---

# Legislative Fiscal Division

## Revenue Estimate Profile

### Cultural Trust Interest

---

**Revenue Description:** Beginning in FY 1976, a portion of coal severance tax revenue was deposited into the Parks Acquisition and Arts Protection trust fund. The 1991 Legislature split the principal of this trust into two separate trusts, the Parks Acquisition trust and the Arts Protection trust (cultural trust), with coal severance taxes allocated to each one. The 1997 Legislature appropriated \$3.9 million from the cultural trust fund for the immediate purchase of Virginia and Nevada City properties. This action resulted in a loss of trust interest revenue that otherwise would be used to fund cultural and aesthetic (C&A) projects in the state during the 1999 biennium. Thus, beginning July 1, 1997, and ending June 30, 1999, 0.87% in coal severance tax revenue was allocated to an account in the state special revenue fund to compensate for the lost interest earnings and the previous 0.63% distribution of coal severance tax to the cultural trust was eliminated. Except for FY 2003, beginning July 1, 1999, the amount of 0.63% is once again statutorily allocated to the cultural trust, the interest from which is to be used for the purpose of protection of works of art in the capitol and for other cultural and aesthetic projects. The August 2002 special legislative session eliminated the allocation for FY 2003 only. In HB 9, the 2005 Legislature transferred \$3,412,500 from the general fund to the trust and the 2007 Legislature transferred \$1,500,000 from the general fund to the trust. Both these actions increase the earnings from the trust.

#### Statutory Reference:

Tax Rate - NA  
Distribution (MCA) - 15-35-108(6), 22-2-305  
Date Due - NA

**Applicable Tax Rate(s):** N/A

**Distribution:** All income from the trust is deposited in a state special revenue fund to be appropriated for protection of works of art in the state capitol and for other cultural and aesthetic projects.

#### Distribution Chart:

**State Special Revenue Fund**

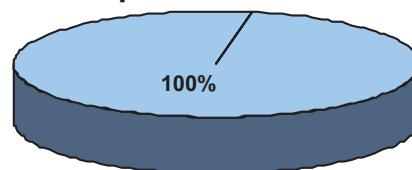

**Collection Frequency:** Monthly

**% of Total General Fund Revenue:** N/A

#### Revenue Estimate Methodology:

##### Data

The data used to estimate the interest and earnings of the cultural trust are collected from the Board of Investments (BOI), IHS, and the state accounting system (SABHRS). The BOI provides historic interest earnings from the trust as well as the gains and losses from the sale of investment instruments. Projections of interest rates are provided by IHS, and historic earnings are provided from SABHRS. No adjustments are required on the raw data in preparation for analysis.

##### Analysis

The cultural trust, formed in the late 1970's, was created from distributions of the coal severance tax. The cultural trust receives coal tax distributions at the rate of 0.63% of the total tax. In several years of budget stress, the coal tax distribution to the cultural trust was temporarily eliminated or reduced. The principal of the trust was reduced by \$3.9 million in FY 1997 and the funds were used for the purchase of Virginia and Nevada Cities. In FY 2006, the trust was reimbursed for \$3.4 million,

# Legislative Fiscal Division

## Revenue Estimate Profile

### Cultural Trust Interest

substantially increasing the principal of the trust. The principal or corpus of the cultural trust now stands at \$11.2 million, as demonstrated by the line in the figure below. Estimates of future deposits to the cultural trust are developed in the coal severance tax projection and are expected to be \$294,000 in FY 2011, \$297,000 in FY 2012, and \$302,000 in FY 2013.

To forecast the cultural trust interest earnings, each of three interest/income components are estimated independently and combined. The estimated interest/income components include:

- The trust funds bond pool (TFBP)
- The short term investment pool (STIP)
- New trust deposits

The TFBP was formed in 1995 to manage the fixed investments held in the state's major trust funds. TFBP earnings are the largest source of earnings for the trust. The TFBP earnings are estimated by applying a long-term interest rate to the projected TFBP balance. The applicable long term rate is an average of four rates projected by IHS: the corporation Aaa bond rate, the corporate Baa bond rate, the rate on 10-year treasury bonds, and the rate on 30-year treasury bonds. The fiscal year average long-term interest rate is expected to be 4.2% in FY 2011, 4.2% in FY 2012, and 5.0% in FY 2013.

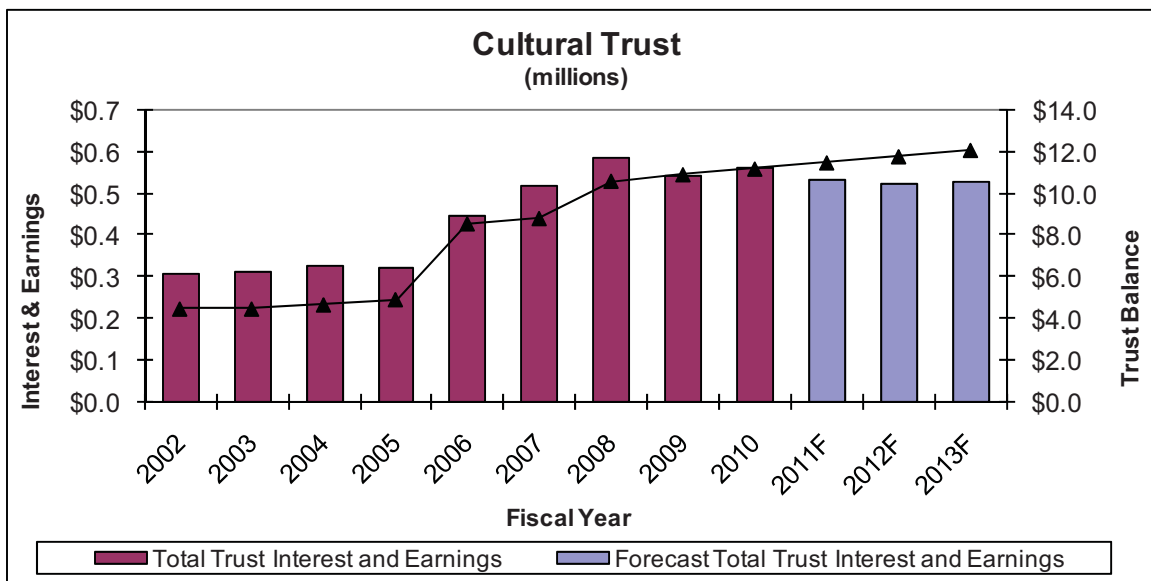

STIP interest is earned on the temporary investment of trust funds. Funds are acquired from activities such as new deposits and investment sales. Funds are held in STIP until the BOI determines that conditions are favorable for deposit in the TFBP. To estimate future STIP earnings, an average short-term interest rate is developed, based on IHS projections of the interest rates on three and six-month corporate loans and three and six-month treasury bills. The average fiscal year short-term interest rate is expected to be 0.3% in FY 2011, 0.9% in FY 2012, and 2.5% in FY 2013.

The 0.63% coal severance tax distribution to the cultural trust is considered new deposits. New deposits are transferred to the trust on a quarterly basis. When the BOI receives the coal tax transfer, the funds are immediately invested in STIP. Funds are expected to remain in STIP for one month before being invested in the TFBP. The interest earned on new deposits is estimated by summing STIP earnings for one month with TFBP earnings for the remainder of the year.

# Legislative Fiscal Division

## Revenue Estimate Profile

### Cultural Trust Interest

**Forecast Methodology:**

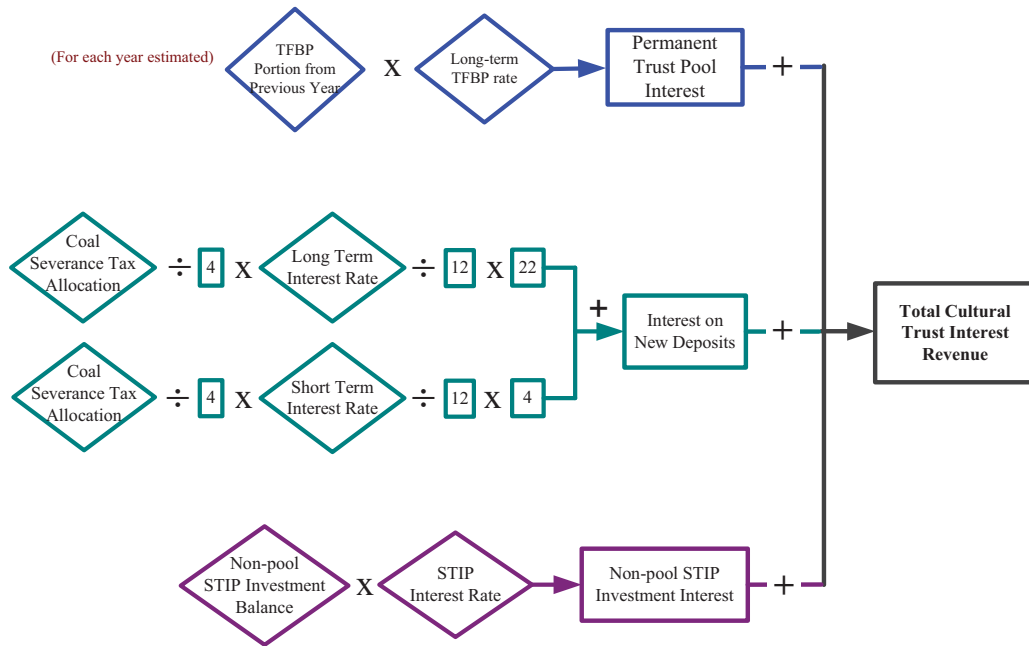

# Legislative Fiscal Division

## Revenue Estimate Profile

### Cultural Trust Interest

#### Revenue Estimate Assumptions:

	t	Total Rev.	GF Rev.	TFBP	STIP	Invested	Average
	<u>Fiscal</u>	<u>Millions</u>	<u>Millions</u>	<u>Interest</u>	<u>Interest</u>	<u>Balance</u>	<u>Return</u>
				<u>Millions</u>	<u>Millions</u>	<u>Millions</u>	<u>Rate</u>
Actual	2000	0.253951	0.000000				
Actual	2001	0.286146	0.000000				
Actual	2002	0.305355	0.000000	0.304397	0.000957		
Actual	2003	0.314131	0.000000	0.310495	0.001135	4.518165	6.9526%
Actual	2004	0.325684	0.000000	0.324526	0.001158	4.693455	6.9391%
Actual	2005	0.318333	0.000000	0.316149	0.002184	4.932287	6.4541%
Actual	2006	0.447040	0.000000	0.421171	0.025868	8.478110	5.2729%
Actual	2007	0.515699	0.000000	0.512569	0.003130	8.784502	5.8706%
Actual	2008	0.584045	0.000000	0.572852	0.011193	10.595200	5.5124%
Actual	2009	0.535495	0.000000	0.534456	0.001039	10.861740	4.9301%
Actual	2010	0.553130	0.000000	0.552634	0.000496	11.095656	4.9851%
Forecast	2011	0.529000	0.000000	0.522686	0.005968	11.389656	4.6415%
Forecast	2012	0.542000	0.000000	0.535075	0.006645	11.685656	4.6358%
Forecast	2013	0.557000	0.000000	0.547386	0.009779	11.986656	4.6482%

	t	Net Coal Tax	New Deposit	Non Pool	Non Pool
	<u>Fiscal</u>	<u>New Deposit</u>	<u>Long Term</u>	<u>STIP</u>	<u>STIP Bal</u>
		<u>Millions</u>	<u>Rate</u>	<u>Rate</u>	<u>Millions</u>
Actual	2000	0.212426	7.0160%	5.4290%	0.249639
Actual	2001	0.203724	6.8850%	4.7390%	0.028633
Actual	2002	0.199168	6.3380%	2.5650%	0.102287
Actual	2003	0.000000	5.7290%	1.3600%	0.062902
Actual	2004	0.198731	5.3650%	1.2650%	0.088412
Actual	2005	0.237097	5.1940%	2.3870%	0.092433
Actual	2006	0.225676	5.2340%	4.0770%	0.063498
Actual	2007	0.256780	5.4050%	4.7290%	0.060001
Actual	2008	0.285591	5.3180%	3.1650%	0.190851
Actual	2009	0.312254	5.1210%	0.9770%	0.137391
Actual	2010	0.278318	4.7440%	0.2120%	0.071307
Forecast	2011	0.294000	4.2140%	0.2500%	0.071307
Forecast	2012	0.296000	4.1590%	0.9150%	0.071307
Forecast	2013	0.301000	5.0340%	2.5430%	0.071307

Total Rev. = Invested Balance × Average Return

# Legislative Fiscal Division

## Revenue Estimate Profile

### Cultural Trust Interest

#### Revenue Projection:

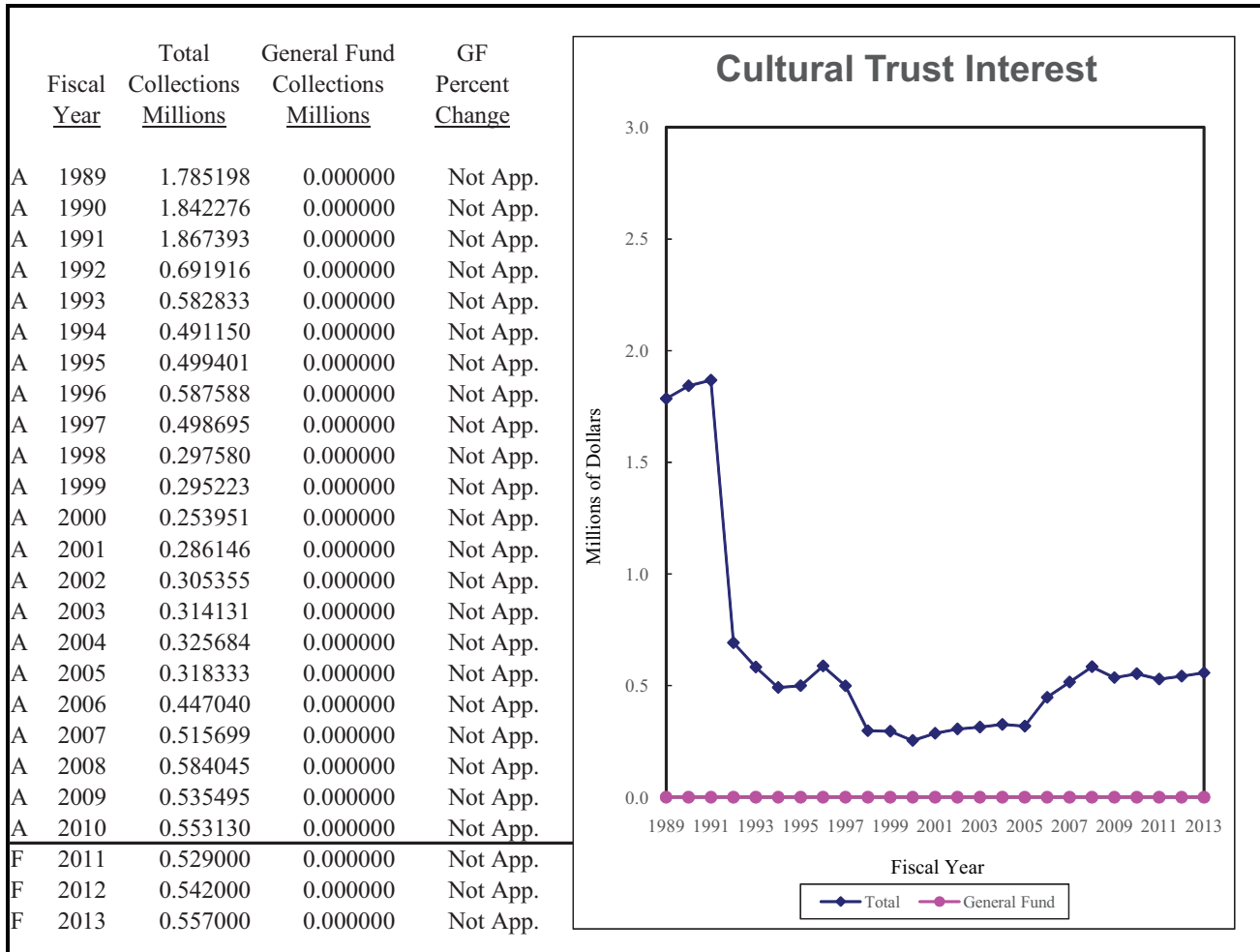

**Data Source(s):** Board of Investments, SABHRS, *Wall Street Journal*, IHS

**Contacts:**



---

# Legislative Fiscal Division

## Revenue Estimate Profile

### Deaf and Blind Trust Interest and Income

---

**Revenue Description:** Lands granted by the federal government to the state for the benefit of public schools and various state institutions generate income. These lands produce revenue through rents or crop shares for agricultural purposes, royalties from the sale of mineral rights, and sales of timber. Income from certain portions of public school/institution lands has been designated for support of the School for the Deaf and Blind. Thus, some of these funds are deposited into a component of the trust and legacy trust fund referred to as the Deaf and Blind trust, which generates interest earnings for the state. As of October 1, 1995, all fixed-income investments held by the state's major trust funds were transferred to a newly-created Trust Funds Bond Pool (TFBP). The majority of trust and legacy trust funds are invested as part of the TFBP. Some funds, however, are invested on a short-term basis in the state's Short Term Investment Pool (STIP). The state constitution prohibits the investment of the permanent trust in common stock.

With the enactment of SB 65 by the 2009 Legislature, up to 25% of Deaf and Blind trust revenue can be diverted to the trust land administration account to fund Department of Natural Resources and Conservation (DNRC) administration costs. This revenue can include distributable revenue, mineral royalties, and timber revenue. Diversions reduce the amount of revenue distribute to the trust beneficiaries. Revenue diverted from the Deaf and Blind permanent trust fund reduces the growth of the trust balance and, hence, reduces the amount of distributable interest earnings. The legislation is effective July 1, 2009.

#### Statutory Reference:

Tax Rate – NA  
Distribution (MCA) – 20-8-110  
Enabling Act, Sections 11 & 17  
Other (MCA) – DNRC trust land administration diversion (77-1-108 & 109)  
DNRC land bank administration diversion (77-2-362)

**Applicable Tax Rate(s):** N/A

**Distribution:** Interest and income from the trust, net of amounts to fund DNRC administration, are allocated to the School for the Deaf and Blind.

#### Distribution Chart:

**State Special Revenue Fund**

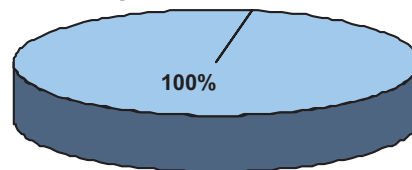

**Collection Frequency:** Monthly

**% of Total General Fund Revenue:** N/A

#### Revenue Estimate Methodology:

The estimate for interest and income from the Deaf and Blind trust determines the net amount of revenue that will be distributed to the trust beneficiary. This means that in addition to estimating the various distributable revenues from the trust, estimates of the diversions that reduce the amount of distributable or permanent revenue must also be estimated. Therefore, the estimated amounts shown for this revenue source are not total revenues, but are net of diversions. Permanent revenue (revenue that is not distributed, but remains in the trust such as from mineral royalties), is estimated as part of the entire Trust and Legacy account (T & L) and earnings are apportioned to this trust according to the number of shares owned.

# Legislative Fiscal Division

## Revenue Estimate Profile

### Deaf and Blind Trust Interest and Income

Data

Data from the state accounting system (SABHRS) provide a history of each individual interest and income revenue component from which estimates can be made. Department of Natural Resources and Conservation (DNRC) annual reports provide additional information such as mineral prices and production and timber estimates. Budget submissions on the state budgeting system (MBARS) provide anticipated amount of diversions.

Analysis

The estimate is derived by first estimating the distributable revenue components and then estimating the amounts of the diversions.

Revenue Components

1. Trust and Legacy Earnings (see the figure below) – The monetary assets of the trust are pooled with monetary assets of other land trusts in the T & L and invested by the Board of Investment in the trust funds bond pool. Based on the number of share each trust owns, a share of the earnings is deposited in each trust. For the Deaf and Blind trust, the actual FY 2010 share percentage of 0.86 is used. The estimation of the total pool earnings is a three stage process:
  - Earnings from new deposits – New deposits in the pool are estimated to be in \$22.0 million in FY 2011, \$20.5 million in FY 2012 and \$22.1 million in FY 2013. This additional money initially earns interest at the short-term rate (0.3% in FY 2011, 0.9% in FY 2012, and 2.5% in FY 2013) before it is invested in a longer term investment (4.2% in FY 2011, 4.2% in FY 2012, and 5.0% in FY 2013).
  - Earnings from existing balance – The pool balance in FY 2010 was \$444.7 million. The majority of these funds have been invested in bonds purchased over the past several year and average a return rate of 5.2%.
  - Non-portfolio earnings – Money not invested in the trust funds bond pool earns interest at the short-term rate of 0.3% in FY 2009, 0.9% in FY 2010, and 2.5% in FY 2011 on a balance of \$11.3 million, the actual balance from FY 2010.

Once the total amount of the pool earnings has been estimated by summing the above three items, the Deaf and Blind trust share of 0.86% is applied.
2. Grazing Fees – Rates are tied to the price of cattle. Cattle prices are expected to be close to those experienced in FY 2010. DNRC personnel anticipate the grazing fee revenue will be similar to FY 2010.

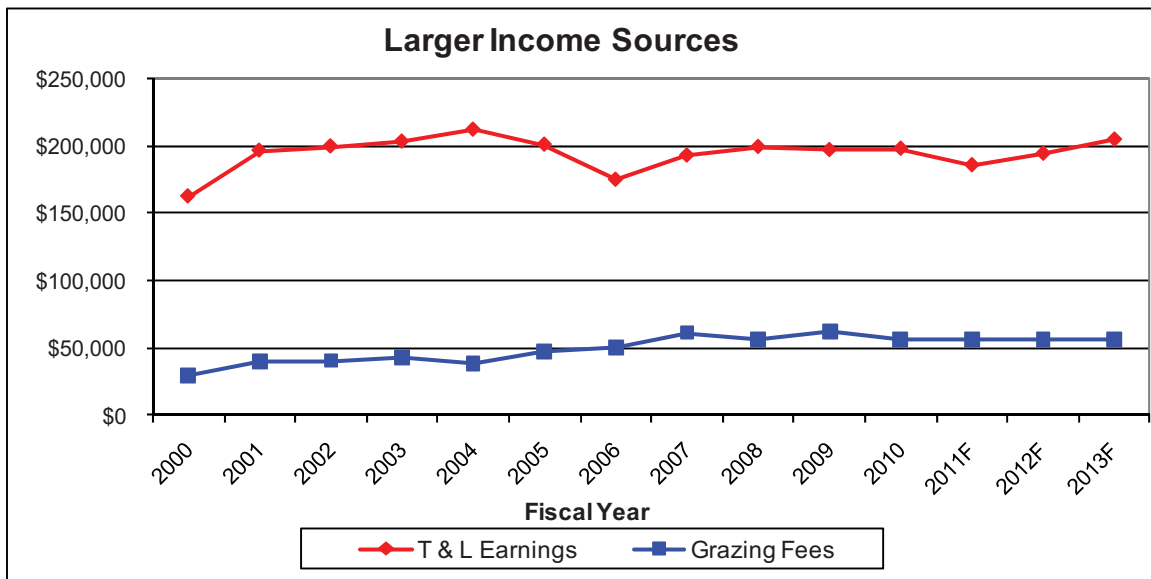

3. Miscellaneous Rentals - These are small income components that are combined and estimated together. For each fiscal year estimated, the estimate is based on the growth rate between FY 2002 and FY 2008.
4. Agricultural Fees – Fees are based on a crop share basis. Commodity prices are expected to be about the same as FY 2010 resulting in similar returns.
5. Oil & Gas Leases – For each fiscal year estimated, the estimate is the average of the previous two years.

# Legislative Fiscal Division

## Revenue Estimate Profile

### Deaf and Blind Trust Interest and Income

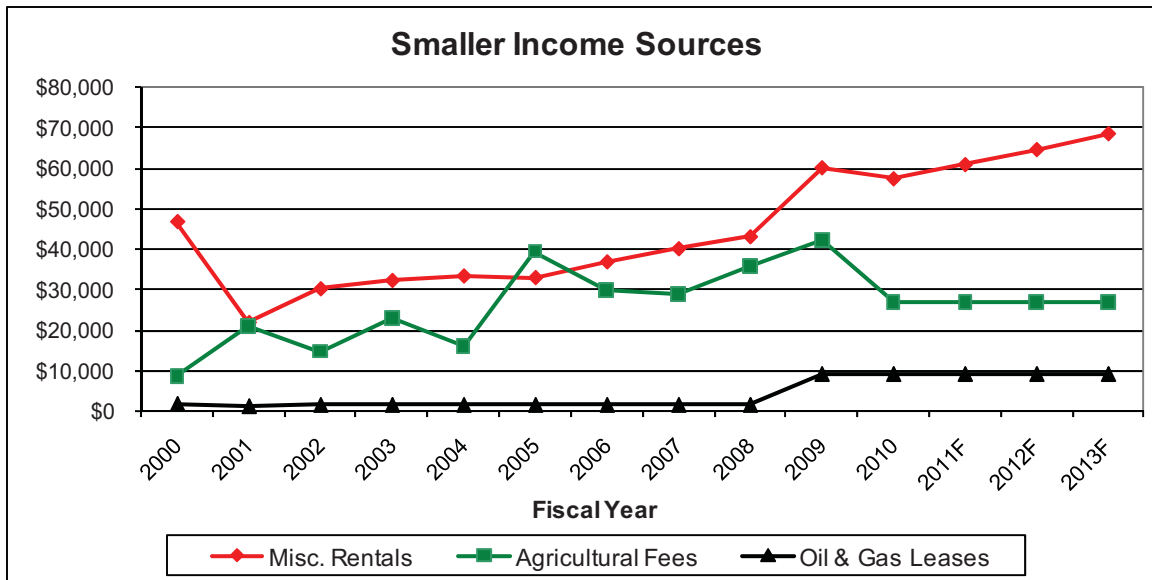

Diversions

- Diversions fund operational costs in DNRC, but reduce the amount of revenue distributed to the trust beneficiaries or permanent revenue deposited to the trust fund (see the figure below). To determine future diversion amounts, DNRC’s present law budget amounts are used. Of the total expenditures requested to be made from this account, a portion is funded by the trust’s distributable revenue. That portion is determined by multiplying current year revenue estimates by the ratio of FY 2010 costs that this trust paid to the total administration costs. In FY 2010, the deaf and blind trust funded 8.5% of total expenditures.

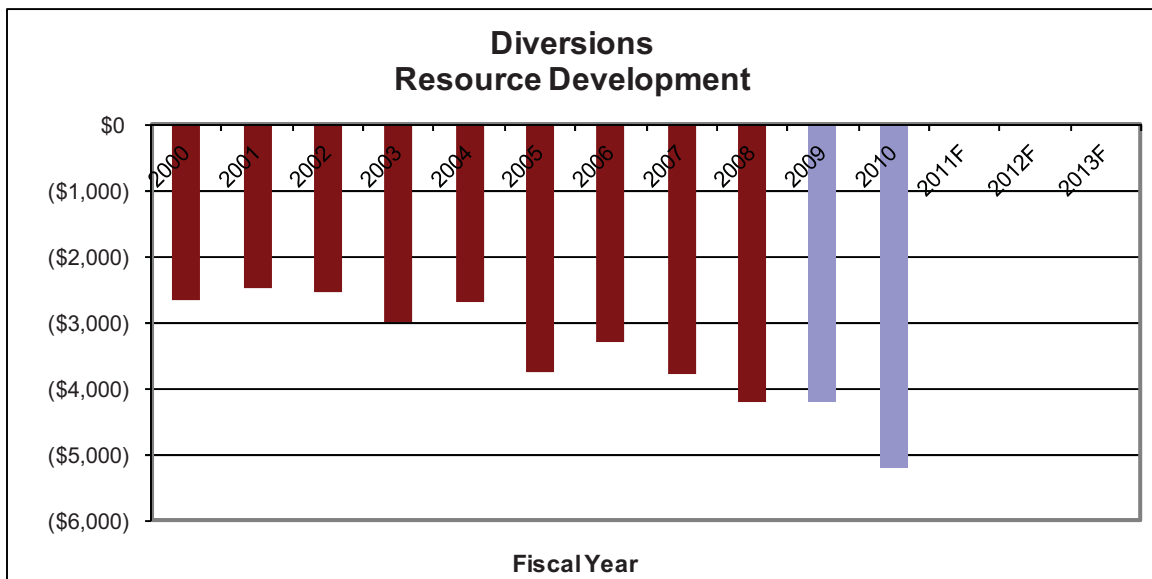

Adjustments and Distribution

Once total revenue and total diversions have been estimated, the net amounts are distributed to the state special revenue fund.

# Legislative Fiscal Division

## Revenue Estimate Profile

### Deaf and Blind Trust Interest and Income

**Forecast Methodology:**

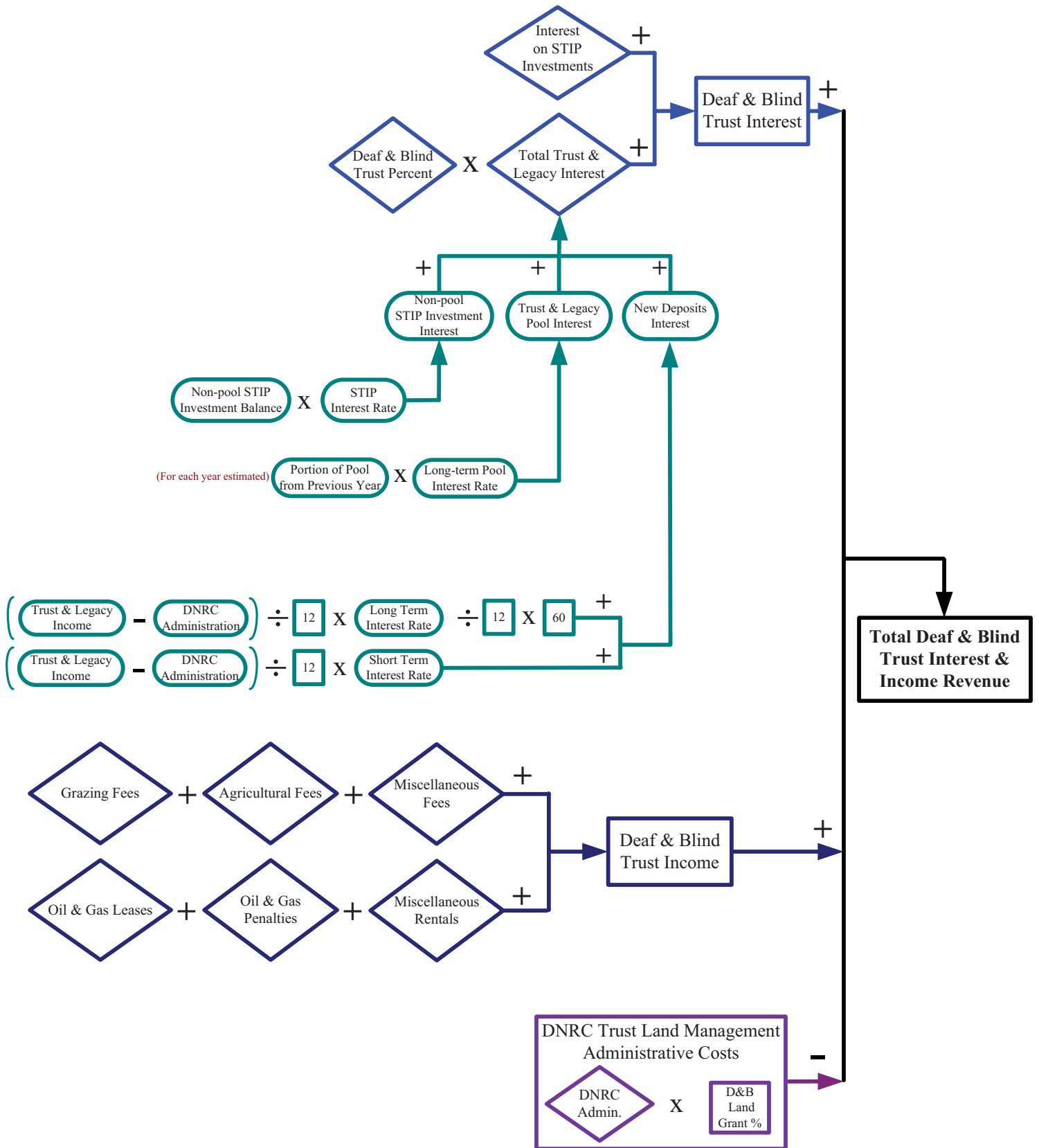

**Legislative Fiscal Division**  
**Revenue Estimate Profile**  
**Deaf and Blind Trust Interest and Income**

**Revenue Estimate Assumptions:**

	t	Total Rev.	GF Rev.	TFBP	STIP	Deaf &
	<u>Fiscal</u>	<u>Millions</u>	<u>Millions</u>	<u>Interest</u>	<u>Interest</u>	<u>Blind Share</u>
				<u>Millions</u>	<u>Millions</u>	<u>T&amp;L</u>
Actual	2000	0.251003	0.000000			0.006369
Actual	2001	0.278974	0.000000			0.007485
Actual	2002	0.284290	0.000000	29.627056	0.102664	0.006697
Actual	2003	0.299569	0.000000	29.146744	0.068370	0.006947
Actual	2004	0.299050	0.000000	30.087011	0.053502	0.007029
Actual	2005	0.318818	0.000000	28.106281	0.269698	0.007072
Actual	2006	0.290605	0.000000	24.428206	0.408162	0.007029
Actual	2007	0.323431	0.000000	26.206838	0.267652	0.007275
Actual	2008	0.334289	0.000000	25.159580	0.128925	0.007867
Actual	2009	0.373046	0.000000	22.711371	0.066450	0.008635
Actual	2010	0.264973	0.000000	22.916114	0.018370	0.008619
Forecast	2011	0.257000	0.000000	21.081910	0.427096	0.008619
Forecast	2012	0.265000	0.000000	22.008854	0.494929	0.008619
Forecast	2013	0.279000	0.000000	22.862477	0.859802	0.008619

	t	Trust Income	Trust Land	New Deposit	Non Pool	Non Pool
	<u>Fiscal</u>	<u>New Deposit</u>	<u>Admin.</u>	<u>Long Term</u>	<u>STIP</u>	<u>STIP Bal</u>
		<u>Millions</u>	<u>Millions</u>	<u>Rate</u>	<u>Rate</u>	<u>Millions</u>
Actual	2000	10.969295	0.000000	7.0160%	5.4290%	11.676486
Actual	2001	12.667780	0.000000	6.8850%	4.7390%	6.984553
Actual	2002	2.348339	0.000000	6.3380%	2.5650%	7.334239
Actual	2003	2.363355	0.000000	5.7290%	1.3600%	6.242273
Actual	2004	2.971526	0.000000	5.3650%	1.2650%	7.049634
Actual	2005	1.457756	0.000000	5.1940%	2.3870%	12.106697
Actual	2006	1.425106	0.000000	5.2340%	4.0770%	3.862666
Actual	2007	7.173844	0.000000	5.4050%	4.7290%	14.953757
Actual	2008	3.101654	0.000000	5.3180%	3.1650%	2.461097
Actual	2009	4.125990	0.000000	5.1210%	0.9770%	4.161322
Actual	2010	10.709883	0.000000	4.7440%	0.2120%	11.339709
Forecast	2011	21.996772	0.000000	4.2140%	0.2500%	11.339709
Forecast	2012	20.524718	0.000000	4.1590%	0.9150%	11.339709
Forecast	2013	22.106856	0.000000	5.0340%	2.5430%	11.339709

**Legislative Fiscal Division**  
**Revenue Estimate Profile**  
**Deaf and Blind Trust Interest and Income**

	<u>t</u> <u>Fiscal</u>	<u>Grazing</u> <u>Millions</u>	<u>Agriculture</u> <u>Millions</u>	<u>Misc.</u> <u>Millions</u>	<u>O&amp;G Lease</u> <u>Millions</u>	<u>O&amp;G Bonus</u> <u>Millions</u>	<u>O&amp;G Penalty</u> <u>Millions</u>	<u>Misc.</u> <u>Millions</u>
Actual	2000	0.030113	0.008628	0.000000	0.001980	0.001280	0.000000	0.046783
Actual	2001	0.040496	0.020937	0.000000	0.001440	0.000480	0.000000	0.021847
Actual	2002	0.040733	0.014776	0.000000	0.001740	0.000050	0.000000	0.030166
Actual	2003	0.042676	0.022940	0.000000	0.001740	0.000000	0.000000	0.032230
Actual	2004	0.038658	0.016168	0.000000	0.001740	0.000000	0.000000	0.033333
Actual	2005	0.047753	0.039470	0.000000	0.001740	0.000000	0.000000	0.032938
Actual	2006	0.050892	0.029866	0.000000	0.001740	0.000000	0.000000	0.036823
Actual	2007	0.061308	0.028854	0.000000	0.001740	0.000000	0.002650	0.040075
Actual	2008	0.056117	0.035755	0.000000	0.001740	0.000000	0.002900	0.043035
Actual	2009	0.061789	0.042106	0.000000	0.009060	0.008120	0.002900	0.060102
Actual	2010	0.056077	0.026889	0.000000	0.009060	0.000000	0.002900	0.057373
Forecast	2011	0.056077	0.026889	0.000000	0.009060	0.000000	0.002900	0.060873
Forecast	2012	0.056077	0.026889	0.000000	0.009060	0.000000	0.002900	0.064587
Forecast	2013	0.056077	0.026889	0.000000	0.009060	0.000000	0.002900	0.068527

	<u>t</u> <u>Fiscal</u>	<u>Int. Land</u> <u>Millions</u>	<u>Int. STIP</u> <u>Millions</u>	<u>Int. Trust</u> <u>Millions</u>	<u>Timber</u> <u>Millions</u>	<u>Res. Dev.</u> <u>Millions</u>	<u>TLMD Adm.</u> <u>Millions</u>
Actual	2000	0.000000	0.000000	0.162218	0.000000	-0.002664	
Actual	2001	0.000000	0.000000	0.196256	0.000000	-0.002482	
Actual	2002	0.000000	0.000000	0.199373	0.000000	-0.002548	
Actual	2003	0.000000	0.000000	0.202971	0.000000	-0.002988	
Actual	2004	0.000000	0.000000	0.211848	0.000000	-0.002697	
Actual	2005	0.000000	0.000000	0.200675	0.000000	-0.003758	
Actual	2006	0.000000	0.000000	0.174578	0.000000	-0.003294	
Actual	2007	0.000000	0.000000	0.192597	0.000000	-0.003793	
Actual	2008	0.000000	0.000000	0.198956	0.000000	-0.004214	
Actual	2009	0.000000	0.000000	0.196678	0.000000	-0.005201	
Actual	2010	0.000000	0.000000	0.197661	0.000000	0.000000	-0.084986
Forecast	2011	0.000000	0.000000	0.185386	0.000000	0.000000	-0.084675
Forecast	2012	0.000000	0.000000	0.193960	0.000000	0.000000	-0.088929
Forecast	2013	0.000000	0.000000	0.204462	0.000000	0.000000	-0.089204

Total Rev. = Grazing + Agriculture + O&G Lease + O&G Bonus + O&G Penalty + Misc. +  
 Int. Land + Int. Stip + Int. Trust + Timber + Res. Dev.+ TLMD Adm.

# Legislative Fiscal Division

## Revenue Estimate Profile

### Deaf and Blind Trust Interest and Income

**Revenue Projection:**

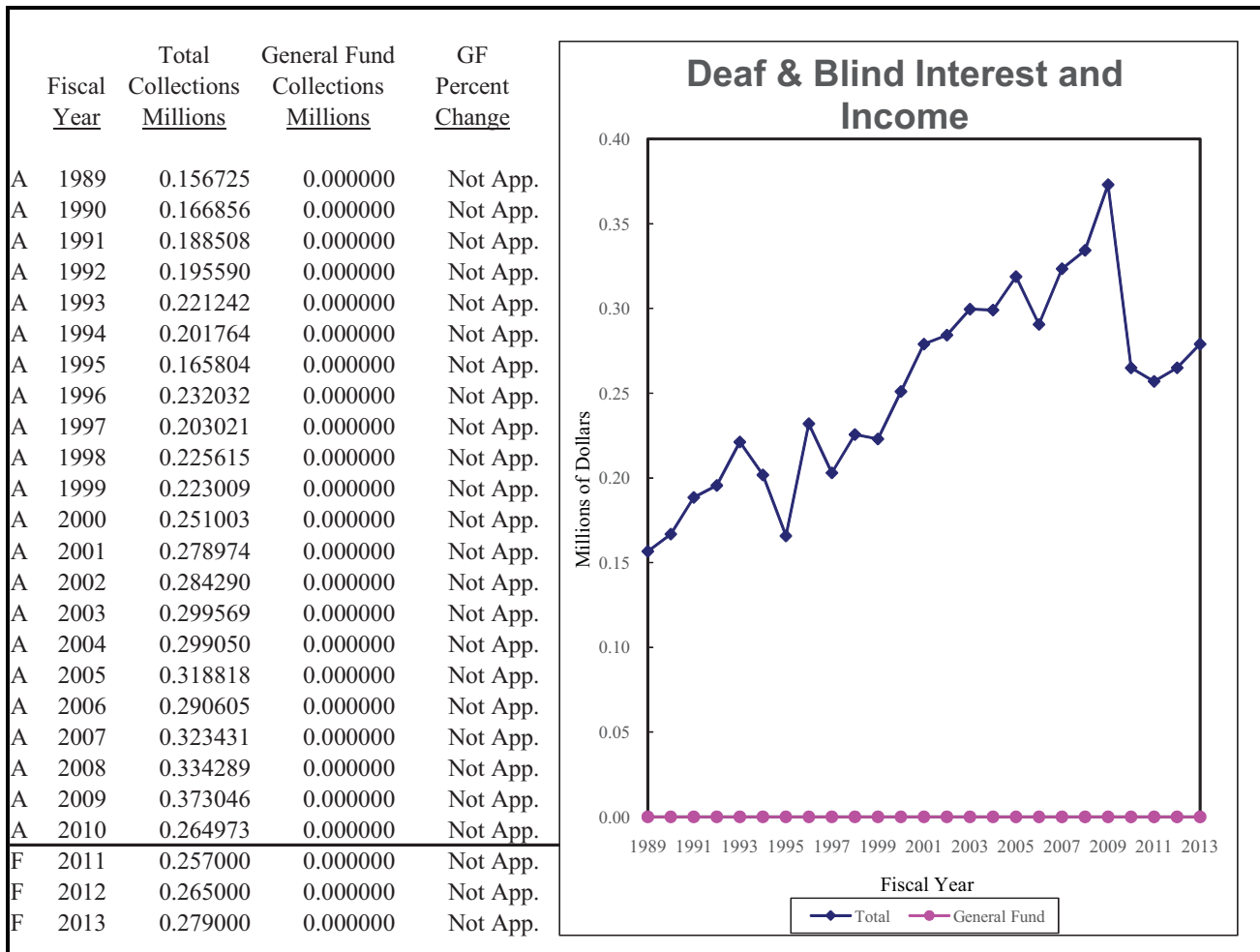

**Data Source(s):** Board of Investments, SABHRS, *Wall Street Journal*, IHS, Department of Natural Resources and Conservation

**Contacts:** Department of Natural Resources and Conservation

---

# Legislative Fiscal Division

## Revenue Estimate Profile

### Economic Development Trust Interest

---

**Revenue Description:** Article IX, Section 5 of the Montana Constitution requires that 50% of all coal severance tax revenue be deposited in a permanent coal trust fund and that the principal of the trust "shall forever remain inviolate unless appropriated by a three-fourths vote of each house". Coal severance tax funds flowing into the trust fund are first used to secure and subsidize state bonds issued to finance water resource and renewable resource development projects and activities. With the enactment of House Bill 249 by the 2005 Legislature, beginning FY 2006 the remaining funds are then split 50% (25% of total revenue) to the treasure state endowment trust fund, 25% (12.5% of total revenue) to the treasure state endowment regional water system trust fund, and 25% (12.5% of total revenue) to the big sky economic development trust fund. The permanent trust fund no longer receives coal severance tax revenue.

As of October 1, 1995, all fixed-income investments held by the state's major trust funds were transferred to a newly-created trust funds bond pool (TFBP). The majority of permanent coal tax trust funds are invested as part of the TFBP. Some funds, however, are invested on a short-term basis in the state's short-term investment pool (STIP). In addition, state law provides that trust funds may be used for in-state commercial loans to stimulate economic development.

#### Statutory Reference:

Tax Rate – NA  
Distribution (MCA) – 17-5-703 (5b); use of earnings (90-1-205)  
Date Due (MCA) – monthly (17-5-703(5b))

**Applicable Tax Rate(s):** N/A

**Distribution:** Interest earnings are deposited to a state special revenue fund and are statutorily appropriated to the Department of Commerce to pay administrative expenses with the remainder for:

1. 75% to local governments to be used for job creation; and
2. 25% to certified regional development corporations and economic development organizations

#### Distribution Chart:

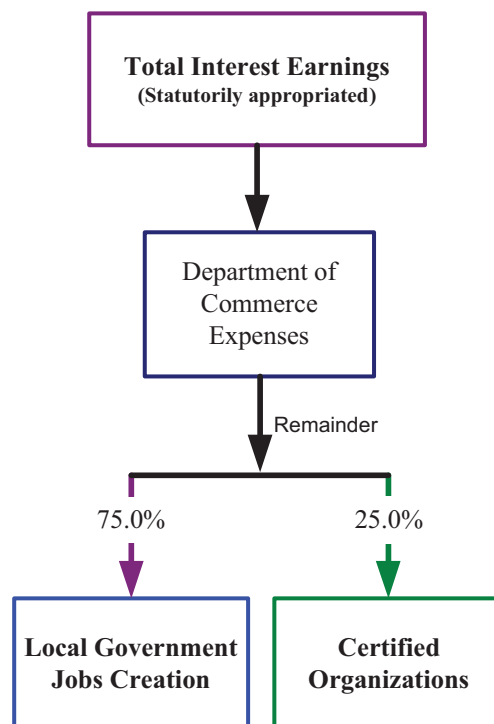



---

# Legislative Fiscal Division

## Revenue Estimate Profile

### Economic Development Trust Interest

---

**Collection Frequency:** Monthly

**% of Total General Fund Revenue:** N/A

- Economic Factors
  - Prevailing national interest and bond rates
  - Inflationary pressures
  - Coal price
  - Coal production costs
- Social Factors - None
- Legislative Factors
  - State legislative impacts
    - Coal severance tax and distribution related changes
    - Constitutional restrictions on types of investments (i.e. no investments in equities)
    - Appropriations from the trust sub-fund
  - Federal legislative impacts

#### **Revenue Estimate Methodology:**

##### Data

The data used to estimate interest earnings from the big sky economic trust are obtained from the Board of Investments (BOI), IHS, and the state accounting system (SABHRS). The BOI provides information on historic interest rates as well as the gains and losses from the sale of securities. Projections of future interest rates are provided by IHS and historic interest collections are obtained from SABHRS.

##### Analysis

The economic trust was created from distributions of the coal severance tax. The economic trust was formed in FY 2006 as a sub-trust to the permanent coal trust. The Constitution requires that 50% of the coal severance tax collections be distributed to the coal trust, and 25% of that distribution (after the water bond debt service obligation is met) or 12.5% of total coal severance tax revenues is distributed to the Big Sky Economic Development trust. The principal or corpus of the trust now stands at \$49.9 million. Estimates of future deposits to the trust are developed in the coal severance tax projection and are expected to be \$5.8 million in FY 2011, \$5.8 million in FY 2012, and \$5.9 million in FY 2012.

To forecast the economic trust interest earnings, each of the following three interest/income components are estimated independently and combined:

- Trust funds bond pool (TFBP)
- Short-term investment pool (STIP)
- New trust deposits

The TFBP was formed in 1995 to manage the fixed investments held in the state's major trust funds. Each trust owns "shares" of the pool and interest earnings are paid to each trust on a per-share basis. TFBP earnings are the largest source of earnings for the trust, as shown in the figure below. To estimate TFBP earnings, the base year (FY 2010) rate of return generated by the pool, as reported by the BOI, is adjusted during the forecast period for maturing securities. The applicable new long-term rate for these securities is based on an average of four long-term rates projected by IHS. The fiscal year average long-term interest rate is expected to be 4.2% in FY 2011, 4.2% in FY 2012, and 5.0% in FY 2013.

# Legislative Fiscal Division

## Revenue Estimate Profile

### Economic Development Trust Interest

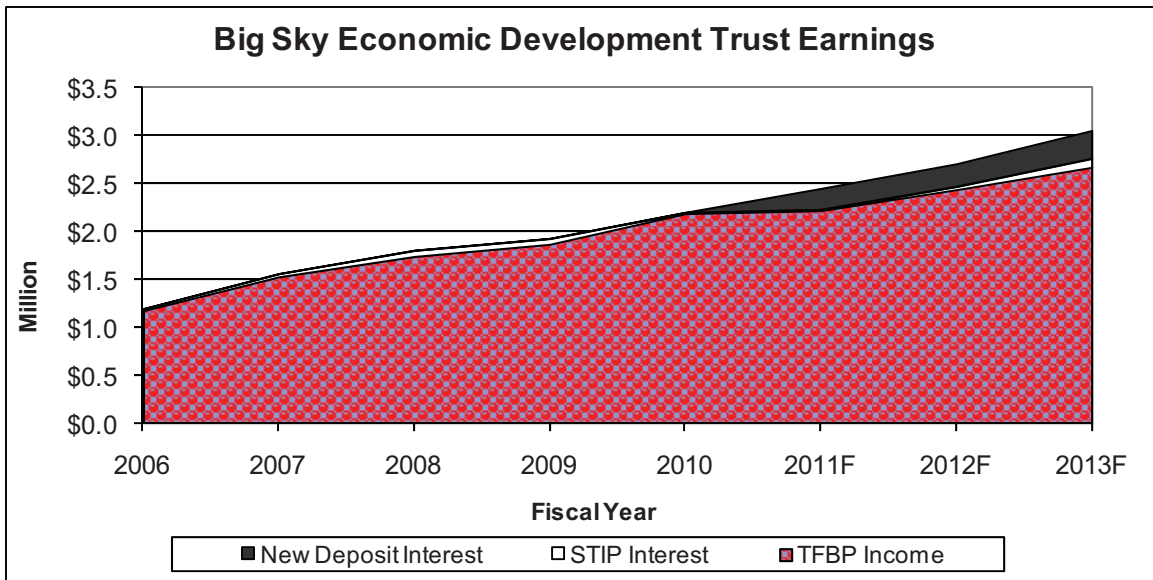

STIP interest (including other interest) is earned on cash, prior to investment in long-term investments. Funds are acquired from new deposits and/or maturing securities in the forecast period. Funds are held in STIP until the BOI determines that conditions are favorable for investment in the TFBP. To estimate future STIP earnings, an average short-term interest rate is developed, based on IHS projections of three short-term investments. The average fiscal year short-term interest rate is expected to be 0.3% in FY 2011, 0.9% in FY 2012, and 2.5% in FY 2013.

Coal severance tax distributions to the trust are considered new deposits. New deposits are transferred to the trust on a quarterly basis. When the BOI receives the coal tax transfer, the funds are immediately invested in STIP. Funds are expected to remain in STIP for one month before being invested in the TFBP. The interest earned on new deposits is estimated by summing STIP earnings for one month with TFBP earnings for the remainder of the year.

#### Forecast Methodology:

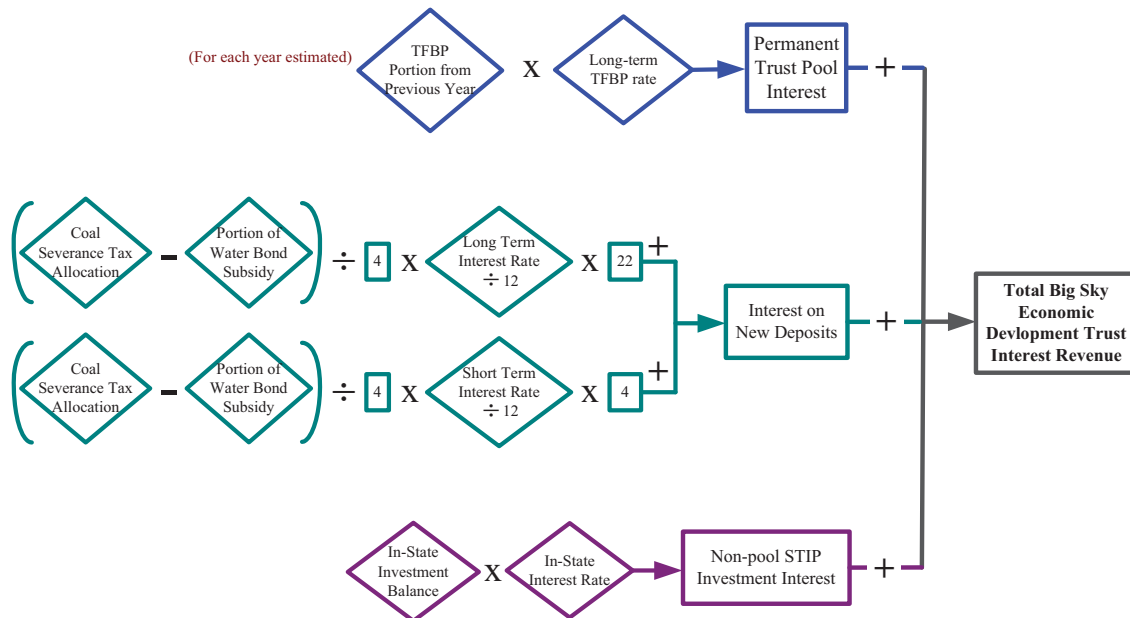

**Legislative Fiscal Division**  
**Revenue Estimate Profile**  
**Economic Development Trust Interest**

**Revenue Estimate Assumptions:**

	t	Total Rev.	GF Rev.	TFBP	STIP	Loan	Invested	Average
	<u>Fiscal</u>	<u>Millions</u>	<u>Millions</u>	<u>Interest</u>	<u>Interest</u>	<u>Interest</u>	<u>Balance</u>	<u>Return</u>
				<u>Millions</u>	<u>Millions</u>	<u>Millions</u>	<u>Millions</u>	<u>Rate</u>
Actual	2000	0.000000	0.000000					
Actual	2001	0.000000	0.000000					
Actual	2002	0.000000	0.000000	0.000000	0.000000	0.000000	0.000000	0.000000
Actual	2003	0.000000	0.000000	0.000000	0.000000	0.000000	0.000000	0.000000
Actual	2004	0.000000	0.000000	0.000000	0.000000	0.000000	0.000000	0.000000
Actual	2005	0.000000	0.000000	0.000000	0.000000	0.000000	0.000000	0.000000
Actual	2006	1.193690	0.000000	1.174442	0.019250	0.000000	23.608298	0.050562
Actual	2007	1.559210	0.000000	1.526434	0.032775	0.000000	29.122282	0.053540
Actual	2008	1.801342	0.000000	1.738420	0.062922	0.000000	37.683830	0.047801
Actual	2009	1.925222	0.000000	1.866576	0.058647	0.000000	43.191241	0.044574
Actual	2010	2.195909	0.000000	2.185328	0.010580	0.000000	49.755037	0.044134
Forecast	2011	2.328000	0.000000	2.217890	0.110103	0.000000	54.907037	0.042399
Forecast	2012	2.579000	0.000000	2.434995	0.143852	0.000000	60.527037	0.042607
Forecast	2013	2.904000	0.000000	2.668731	0.235428	0.000000	66.234037	0.043847

	t	Net Coal Tax	New Deposit	Non Pool	Non Pool
	<u>Fiscal</u>	<u>New Deposit</u>	<u>Long Term</u>	<u>STIP</u>	<u>STIP Bal</u>
		<u>Millions</u>	<u>Rate</u>	<u>Rate</u>	<u>Millions</u>
Actual	2000	0.000000	6.3380%	5.4290%	0.000000
Actual	2001	0.000000	6.8850%	4.7390%	0.000000
Actual	2002	0.000000	6.3380%	2.5650%	0.000000
Actual	2003	0.000000	5.7290%	1.3600%	0.000000
Actual	2004	0.000000	5.3650%	1.2650%	0.000000
Actual	2005	0.000000	5.1940%	2.3870%	0.000000
Actual	2006	4.477691	5.2340%	4.0770%	0.608562
Actual	2007	5.094842	5.4050%	4.7290%	0.272955
Actual	2008	5.666484	5.3180%	3.1650%	3.214739
Actual	2009	6.195515	5.1210%	0.9770%	2.172150
Actual	2010	5.522179	4.7440%	0.2120%	2.975946
Forecast	2011	5.152000	4.2140%	0.2500%	2.975946
Forecast	2012	5.620000	4.1590%	0.9150%	2.975946
Forecast	2013	5.707000	5.0340%	2.5430%	2.975946

Total Rev. = Invested Balance × Average Return

# Legislative Fiscal Division

## Revenue Estimate Profile

### Economic Development Trust Interest

#### Revenue Projection:

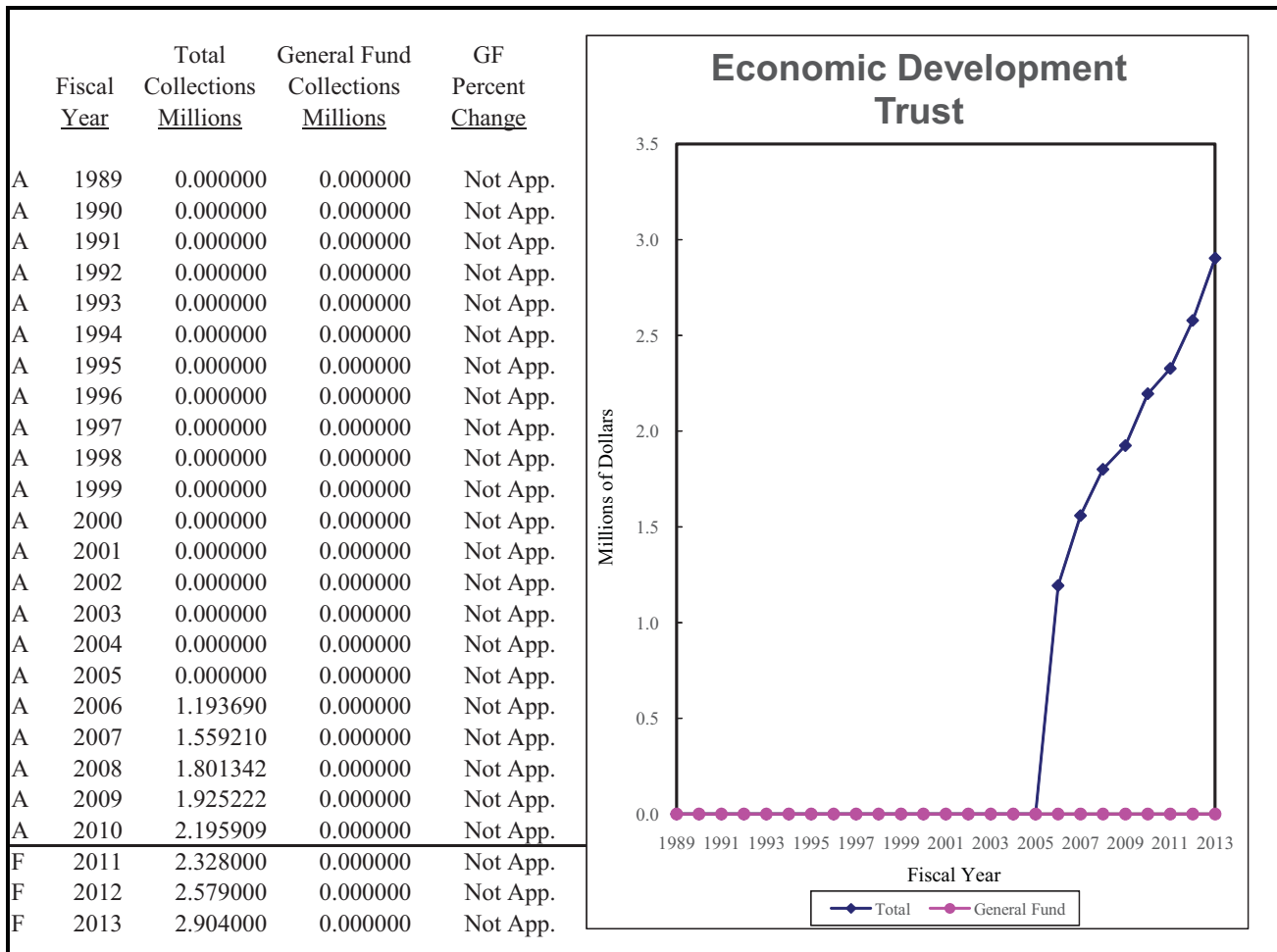

**Data Source(s):** Board of Investments, SABHRS, *Wall Street Journal*, IHS, Department of Natural Resources and Conservation

**Contacts:** Department of Natural Resources and Conservation

---

# Legislative Fiscal Division

## Revenue Estimate Profile

### Parks Trust Interest

---

**Revenue Description:** Beginning in FY 1976, a portion of coal severance tax revenue was deposited into the Parks Acquisition and Arts Protection trust fund. The 1991 Legislature split the principal of this trust into two separate trusts, the Parks Acquisition trust (parks trust) and the Arts Protection trust (cultural trust), with coal severance taxes allocated to each one. Except for FY 2003, the amount of 1.27% of coal tax revenues is statutorily allocated to the parks trust for the purpose of parks acquisition or management. The August 2002 special legislative session eliminated the allocation for FY 2003 only. Income from the parks trust must be appropriated for the acquisition, development, operation, and maintenance of state parks, state recreational areas, state monuments, and state historical sites under control of the Department of Fish, Wildlife and Parks.

**Statutory Reference:**

Tax Rate – NA  
Distribution (MCA) – 15-35-108(4)  
Date Due – NA

**Applicable Tax Rate(s):** N/A

**Distribution:** Interest earnings on the parks trust are allocated to the Department of Fish, Wildlife, and Parks and deposited to a state special revenue fund.

Distribution Chart:

**State Special Revenue Fund**

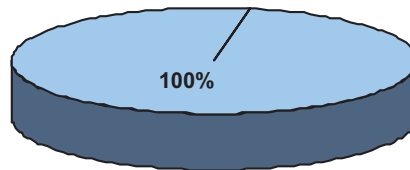

**Collection Frequency:** Monthly

**% of Total General Fund Revenue:** N/A

**Revenue Estimate Methodology:**

Data

The data used to estimate interest earnings from the parks trust are obtained from the Board of Investments (BOI), IHS, and the state accounting system (SABHRS). The BOI provides information on historic interest rates as well as the gains and losses from the sale of securities. Projections of future interest rates are provided by IHS and historic interest collections are obtained from SABHRS.

Analysis

The parks trust, formed in the late 1970's, was created from distributions of the coal severance tax. The parks trust receives coal tax distributions at the rate of 1.27% of the total tax. In one year of budget stress, the coal tax distribution to the parks trust was temporarily eliminated. The principal or corpus of the parks trust now stands at \$20.2 million, as demonstrated by the line in the figure below. Estimates of future deposits to the parks trust are developed in the coal severance tax projection and are expected to be \$593,000 in FY 2011, \$598,000 in FY 2012, and \$608,000 in FY 2013.

# Legislative Fiscal Division

## Revenue Estimate Profile

### Parks Trust Interest

To forecast the parks trust interest earnings, each of the following three interest/income components are estimated independently and combined:

- Trust funds bond pool (TFBP)
- Short-term investment pool (STIP)
- New trust deposits

The TFBP was formed in 1995 to manage the fixed investments held in the state's major trust funds. Each trust owns "shares" of the pool and interest earnings are paid to each trust on a per-share basis. TFBP earnings are the largest source of earnings for the trust, as shown in the figure below. To estimate TFBP earnings, the base year (FY 2008) rate of return generated by the pool, as reported by the BOI, is adjusted during the forecast period for maturing securities. The applicable long-term rate for these securities is based on an average of four long-term rates projected by IHS. The fiscal year average long-term interest rate is expected to be 4.2% in FY 2011, 4.2% in FY 2012, and 5.0% in FY 2013.

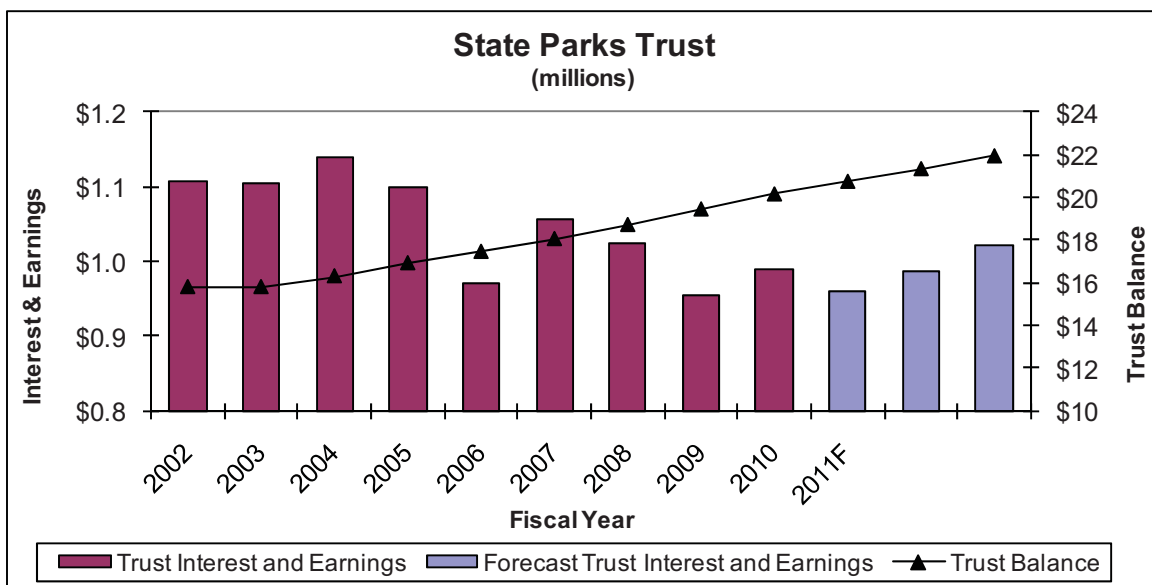

STIP interest (including other interest) is earned on cash, prior to investment in long-term investments. Funds are acquired from new deposits and/or maturing securities in the forecast period. Funds are held in STIP until the BOI determines that conditions are favorable for investment in the TFBP. To estimate future STIP earnings, an average short-term interest rate is developed, based on IHS projections of three short-term investments. The average fiscal year short-term interest rate is expected to be 0.3% in FY 2011, 0.9% in FY 2012, and 2.5% in FY 2013.

The 1.27% coal severance tax distribution to the parks trust is considered new deposits. New deposits are transferred to the trust on a quarterly basis. When the BOI receives the coal tax transfer, the funds are immediately invested in STIP. Funds are expected to remain in STIP for one month before being invested in the TFBP. The interest earned on new deposits is estimated by summing STIP earnings for one month with TFBP earnings for the remainder of the year.

# Legislative Fiscal Division

## Revenue Estimate Profile

### Parks Trust Interest

#### Forecast Methodology:

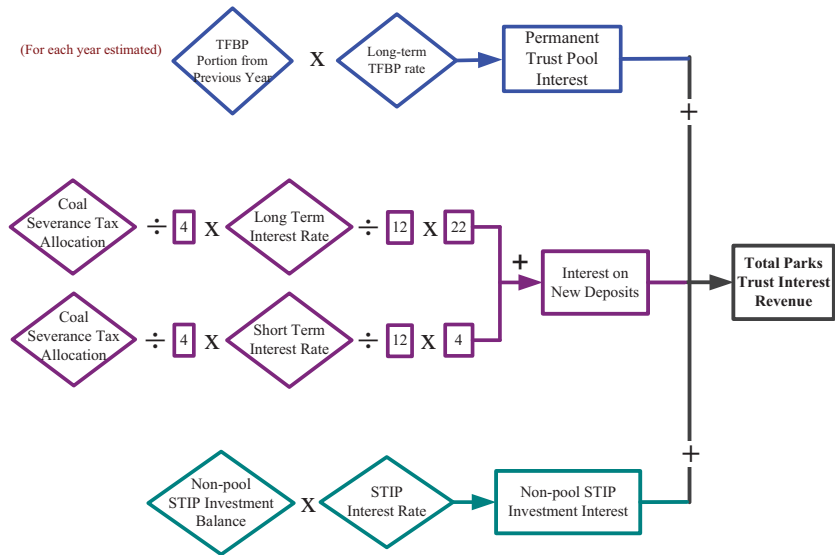

# Legislative Fiscal Division

## Revenue Estimate Profile

### Parks Trust Interest

#### Revenue Estimate Assumptions:

	t	Total Rev.	GF Rev.	TFBP	STIP	Invested	Average
	<u>Fiscal</u>	<u>Millions</u>	<u>Millions</u>	<u>Interest</u>	<u>Interest</u>	<u>Balance</u>	<u>Return</u>
				<u>Millions</u>	<u>Millions</u>	<u>Millions</u>	<u>Rate</u>
Actual	2000	1.050621	0.000000				
Actual	2001	1.083002	0.000000				
Actual	2002	1.105962	0.000000	1.100417	0.005545		
Actual	2003	1.115050	0.000000	1.101342	0.002596		
Actual	2004	1.140447	0.000000	1.138429	0.002019	16.189248	0.070445
Actual	2005	1.100104	0.000000	1.095405	0.004699	16.772286	0.065591
Actual	2006	0.971827	0.000000	0.957207	0.014619	17.305023	0.056159
Actual	2007	1.055431	0.000000	1.034061	0.021370	17.949575	0.058800
Actual	2008	1.024699	0.000000	1.007553	0.017147	18.568502	0.055185
Actual	2009	0.954126	0.000000	0.951427	0.002699	19.283764	0.049478
Actual	2010	0.989327	0.000000	0.988697	0.000630	19.952531	0.049584
Forecast	2011	0.947000	0.000000	0.934518	0.012331	20.544531	0.046088
Forecast	2012	0.974000	0.000000	0.959465	0.014492	21.142531	0.046066
Forecast	2013	1.007000	0.000000	0.984336	0.022743	21.749531	0.046303

	t	Net Coal Tax	New Deposit	Non Pool	Non Pool
	<u>Fiscal</u>	<u>New Deposit</u>	<u>Long Term</u>	<u>STIP</u>	<u>STIP Bal</u>
		<u>Millions</u>	<u>Rate</u>	<u>Rate</u>	<u>Millions</u>
Actual	2000	0.450466	6.3380%	5.4290%	0.301775
Actual	2001	0.410682	6.8850%	4.7390%	0.177151
Actual	2002	0.401498	6.3380%	2.5650%	0.308519
Actual	2003	0.000000	5.7290%	1.3600%	0.140270
Actual	2004	0.400617	5.3650%	1.2650%	0.328045
Actual	2005	0.477958	5.1940%	2.3870%	0.236285
Actual	2006	0.454933	5.2340%	4.0770%	0.469081
Actual	2007	0.517636	5.4050%	4.7290%	0.513863
Actual	2008	0.575715	5.3180%	3.1650%	0.132916
Actual	2009	0.629464	5.1210%	0.9770%	0.138178
Actual	2010	0.561053	4.7440%	0.2120%	0.241945
Forecast	2011	0.592000	4.2140%	0.2500%	0.241945
Forecast	2012	0.598000	4.1590%	0.9150%	0.241945
Forecast	2013	0.607000	5.0340%	2.5430%	0.241945

Total Rev. = Invested Balance × Average Return



# Legislative Fiscal Division

## Revenue Estimate Profile

### Parks Trust Interest

#### Revenue Projection:

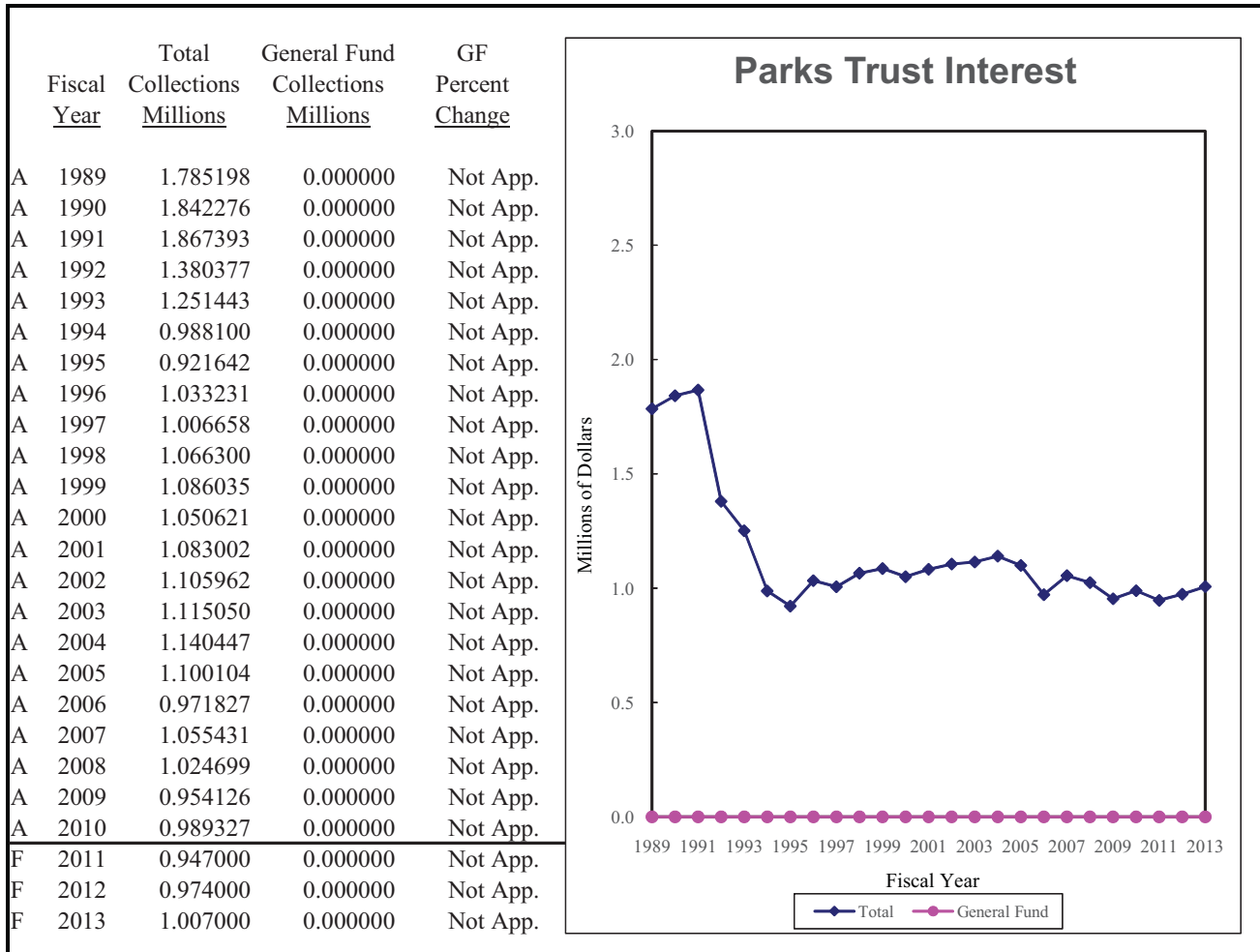

**Data Source(s):** Board of Investments, SABHRS, *Wall Street Journal*, IHS

**Contacts:**

---

# Legislative Fiscal Division

## Revenue Estimate Profile

### Pine Hills Interest and Income

---

**Revenue Description:** Lands granted by the federal government to the state for the benefit of public schools and various state institutions generate income. These lands produce revenue through rents or crop shares for agricultural purposes, royalties from the sale of mineral rights, and sales of timber. Income from certain portions of public school/institution lands has been designated for the support of the Pine Hills youth correctional facility. Thus, some of these funds are deposited into a component of the trust and legacy trust fund referred to as the Pine Hills trust, which generates interest earnings for the state. As of October 1, 1995, all fixed-income investments held by the state's major trust funds were transferred to a newly-created Trust Funds Bond Pool (TFBP). The majority of trust and legacy trust funds are invested as part of the TFBP. Some funds, however, are invested on a short-term basis in the state's Short Term Investment Pool (STIP). The state constitution prohibits the investment of the permanent trust in common stock.

With the enactment of SB 65 by the 2009 Legislature, up to 25% of Pine Hills revenue can be diverted to the trust land administration account to fund Department of Natural Resources and Conservation (DNRC) administration costs. This revenue can include distributable revenue, mineral royalties, and timber revenue. Diversions reduce the amount of revenue distribute to the trust beneficiaries. Revenue diverted from the Pine Hills permanent trust fund reduces the growth of the trust balance and, hence, reduces the amount of distributable interest earnings. The legislation was effective July 1, 2009.

**Statute:**

Tax Rate – NA  
Distribution (MCA) – 17-3-1003  
Enabling Act, Sections 11 & 17  
Other (MCA) – DNRC trust land administration diversion (77-1-108 & 109)  
DNRC land bank administration diversion (77-2-362)

**Applicable Tax Rate(s):** N/A

**Distribution:** Interest and income from the trust, net of amounts to fund DNRC administration, is allocated to the Department of Corrections for support of the Pine Hills youth correctional facility.

Distribution Chart:

**State Special Revenue Fund**

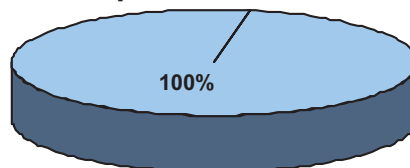

**Collection Frequency:** Monthly

**% of Total General Fund Revenue:** N/A

**Revenue Estimate Methodology:**

The estimate for interest and income from the Pine Hills trust determines the net amount of revenue that will be distributed to the trust beneficiary. This means that in addition to estimating the various distributable revenues from the capital land grant trust, estimates of the diversions that reduce the amount of distributable revenue must also be estimated. Therefore, the estimated amounts shown for this revenue source are not total revenues, but are net of diversions. Permanent revenue (revenue that is not distributed, but remains in the trust such as from timber and mineral royalties), is estimated as part of the entire Trust and Legacy account (T & L) and earnings are portioned to this trust according to the number of shares owned.

# Legislative Fiscal Division

## Revenue Estimate Profile

### Pine Hills Interest and Income

Data

Data from SABHRS provide a history of each individual interest and income revenue component from which estimates can be made. Department of Natural Resources and Conservation (DNRC) annual reports provide additional information such as mineral prices and production and timber estimates. Budget submissions on the state budgeting system (MBARS) provide anticipated amount of diversions.

Analysis

The estimate is derived by first estimating the distributable revenue components and then estimating the amounts of the diversions.

Revenue Components

1. Trust and Legacy Earnings (see the figure below) – The monetary assets of the trust are pooled with monetary assets of other land trusts in the T & L and invested by the Board of Investment in the trust funds bond pool. Based on the number of share each trust owns, a share of the earnings is deposited in each trust. For the Pine Hills trust, the actual FY 2010 share percentage of 0.77 is used. The estimation of the total pool earnings is a three stage process:

- Earnings from new deposits – New deposits in the pool are estimated to be in \$22.0 million in FY 2011, \$20.5 million in FY 2012 and \$22.1 million in FY 2013. This additional money initially earns interest at the short-term rate (0.3% in FY 2011, 0.9% in FY 2012, and 2.5% in FY 2013) before it is invested in a longer term investment (4.2% in FY 2011, 4.2% in FY 2012, and 5.0% in FY 2013).
- Earnings from existing balance – The pool balance in FY 2010 was \$444.7 million. The majority of these funds have been invested in bonds purchased over the past several year and average a return rate of 5.2%.
- Non-portfolio earnings – Money not invested in the trust funds bond pool earns interest at the short-term rate of 0.3% in FY 2009, 0.9% in FY 2010, and 2.5% in FY 2011 on a balance of \$11.3 million, the actual balance from FY 2010.

Once the total amount of the pool earnings has been estimated by summing the above three items, the Pine Hills trust share of 0.77% is applied.

2. Grazing Fees – Rates are tied to the price of cattle. Cattle prices are expected to be close to those experienced in FY 2010. DNRC personnel anticipate the grazing fee revenue will be similar to FY 2010.

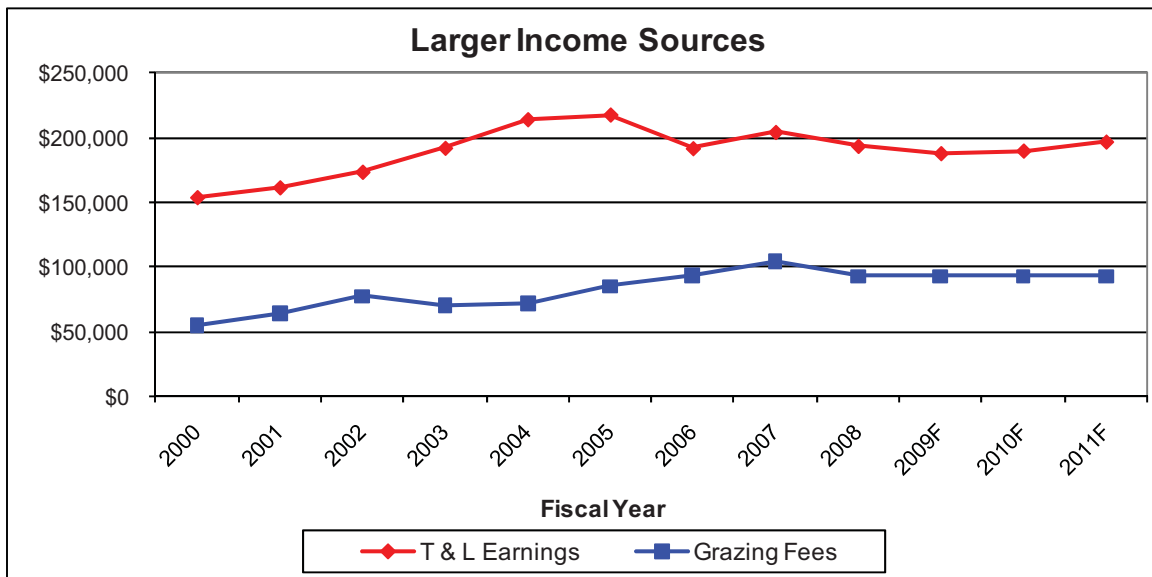

3. Miscellaneous Rentals - These are small income components that are combined and estimated together. For each fiscal year estimated, the estimate is based on the growth rate between FY 2002 and FY 2008.
4. Agricultural Fees – Fees are based on a crop share basis. Commodity prices are expected to be about the same as FY 2010 resulting in similar returns.
5. Oil & Gas Leases – For each fiscal year estimated, the estimate is the average of the previous two years.

# Legislative Fiscal Division

## Revenue Estimate Profile

### Pine Hills Interest and Income

6. Oil & Gas Bonuses & Penalties – No bonus revenue and a small amount of penalty revenue was received in FY 2010. These revenues are continued into the future.

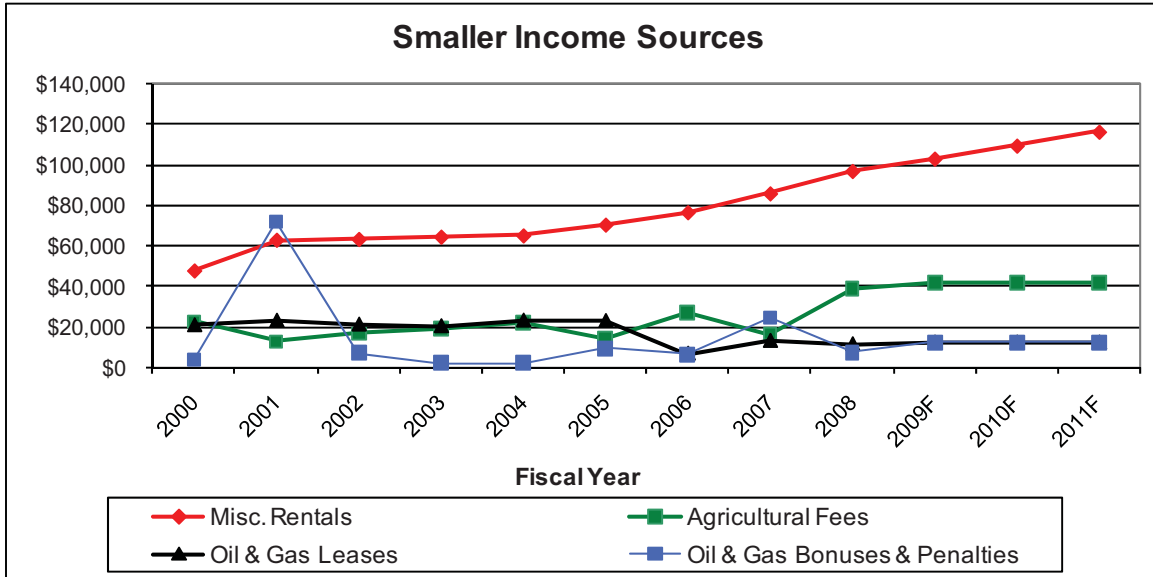

Diversions

1. Diversions fund operational costs in DNRC, but reduce the amount of revenue distributed to the trust beneficiaries (see the figure below). To determine future diversion amounts, DNRC’s present law budget amounts are used. Of the total expenditures requested to be made from this account, a portion is funded by the trust’s distributable revenue. That portion is determined by multiplying current year revenue estimates by the ratio of FY 2010 costs that this trust paid to the total administration costs. In FY 2010, the Pine Hills trust funded 15.8% of total expenditures.

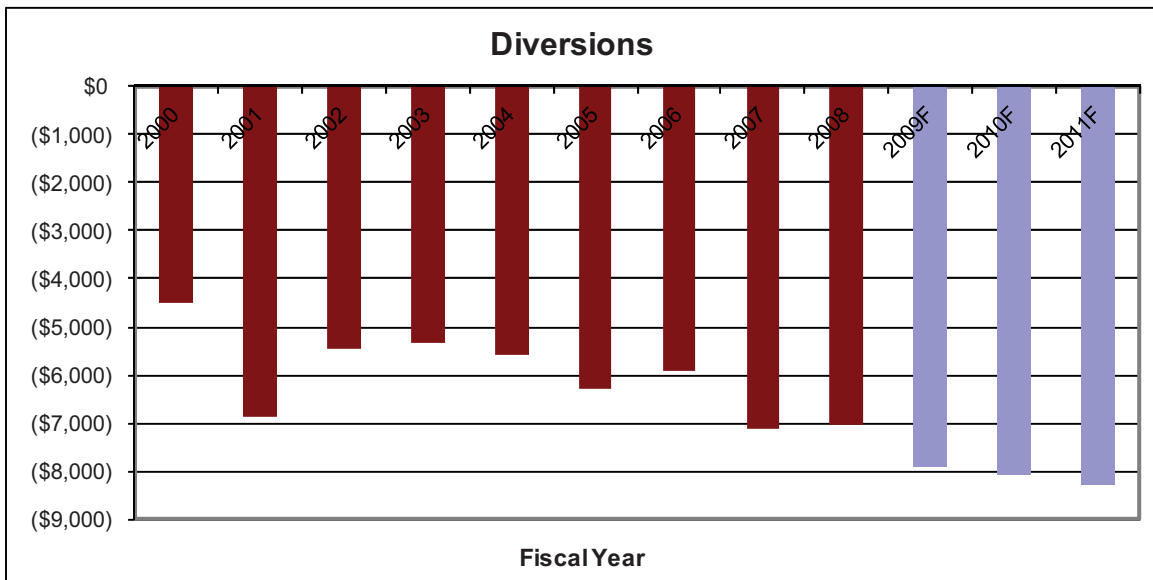

Adjustments and Distribution

Once total revenue and total diversions have been estimated, the net amounts are distributed to the state special revenue fund.

# Legislative Fiscal Division

## Revenue Estimate Profile

### Pine Hills Interest and Income

**Forecast Methodology:**

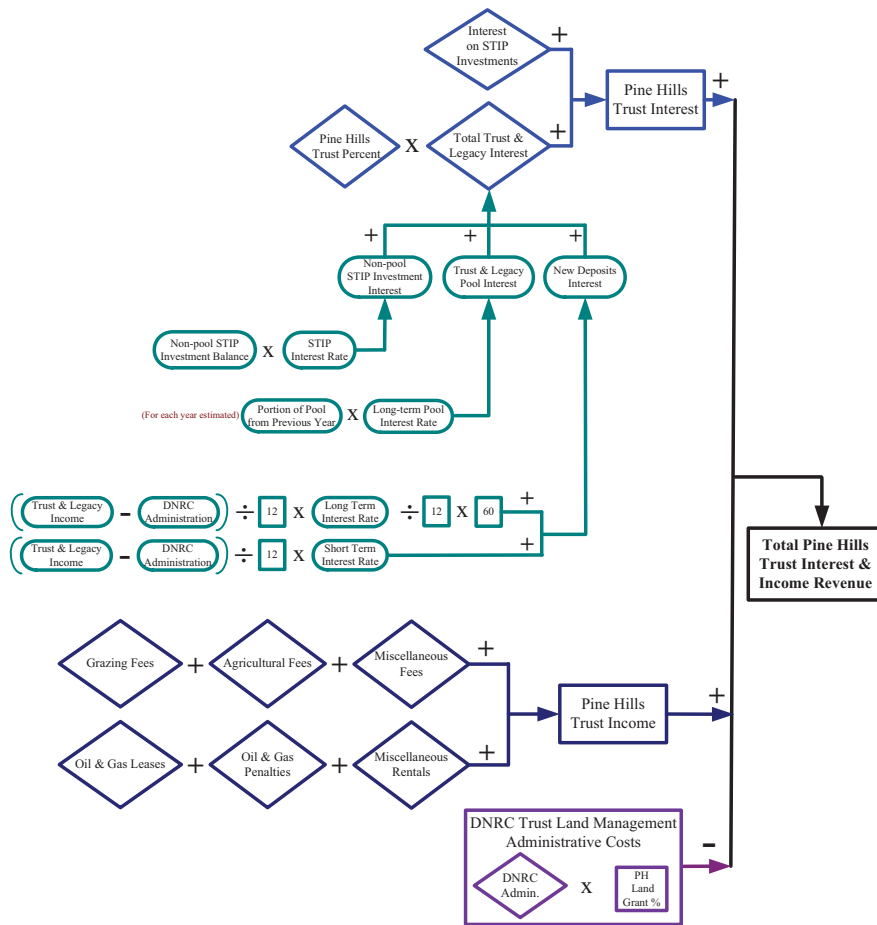

# Legislative Fiscal Division

## Revenue Estimate Profile

### Pine Hills Interest and Income

#### Revenue Estimate Assumptions:

	t	Total Rev.	GF Rev.	TFBP	STIP	Pine
	<u>Fiscal</u>	<u>Millions</u>	<u>Millions</u>	<u>Interest</u>	<u>Interest</u>	<u>Hills Share</u>
				<u>Millions</u>	<u>Millions</u>	<u>T&amp;L</u>
Actual	2000	0.304760	0.000000			0.006048
Actual	2001	0.390483	0.000000			0.006167
Actual	2002	0.355497	0.000000	29.627056	0.102664	0.005835
Actual	2003	0.364450	0.000000	29.146744	0.068370	0.006580
Actual	2004	0.394224	0.000000	30.087011	0.053502	0.007114
Actual	2005	0.415343	0.000000	28.106281	0.269698	0.007685
Actual	2006	0.396937	0.000000	24.428206	0.408162	0.007729
Actual	2007	0.442814	0.000000	26.206838	0.267652	0.007726
Actual	2008	0.434822	0.000000	25.159580	0.128925	0.007661
Actual	2009	0.436708	0.000000	22.711371	0.066450	0.007681
Actual	2010	0.263143	0.000000	22.916114	0.018370	0.007719
Forecast	2011	0.258000	0.000000	21.081910	0.427096	0.007719
Forecast	2012	0.265000	0.000000	22.008854	0.494929	0.007719
Forecast	2013	0.282000	0.000000	22.862477	0.859802	0.007719

	t	Trust Income	Trust Land	New Deposit	Non Pool	Non Pool
	<u>Fiscal</u>	<u>New Deposit</u>	<u>Admin.</u>	<u>Long Term</u>	<u>STIP</u>	<u>STIP Bal</u>
		<u>Millions</u>	<u>Millions</u>	<u>Rate</u>	<u>Rate</u>	<u>Millions</u>
Actual	2000	10.969295	0.000000	7.0160%	5.4290%	11.676486
Actual	2001	12.667780	0.000000	6.8850%	4.7390%	6.984553
Actual	2002	2.348339	0.000000	6.3380%	2.5650%	7.334239
Actual	2003	2.363355	0.000000	5.7290%	1.3600%	6.242273
Actual	2004	2.971526	0.000000	5.3650%	1.2650%	7.049634
Actual	2005	1.457756	0.000000	5.1940%	2.3870%	12.106697
Actual	2006	1.425106	0.000000	5.2340%	4.0770%	3.862666
Actual	2007	7.173844	0.000000	5.4050%	4.7290%	14.953757
Actual	2008	3.101654	0.000000	5.3180%	3.1650%	2.461097
Actual	2009	4.125990	0.000000	5.1210%	0.9770%	4.161322
Actual	2010	10.709883	0.000000	4.7440%	0.2120%	11.339709
Forecast	2011	21.996772	0.000000	4.2140%	0.2500%	11.339709
Forecast	2012	20.524718	0.000000	4.1590%	0.9150%	11.339709
Forecast	2013	22.106856	0.000000	5.0340%	2.5430%	11.339709

# Legislative Fiscal Division

## Revenue Estimate Profile

### Pine Hills Interest and Income

	<u>t</u> <u>Fiscal</u>	<u>Grazing</u> <u>Millions</u>	<u>Agriculture</u> <u>Millions</u>	<u>Misc.</u> <u>Millions</u>	<u>O&amp;G Lease</u> <u>Millions</u>	<u>O&amp;G Bonus</u> <u>Millions</u>	<u>O&amp;G Penalty</u> <u>Millions</u>	<u>Misc.</u> <u>Millions</u>
Actual	2000	0.054682	0.022855	0.047965	0.021231	0.000000	0.003895	0.000000
Actual	2001	0.063912	0.013002	0.063100	0.023526	0.066599	0.005510	0.000000
Actual	2002	0.077707	0.016967	0.063512	0.021550	0.000000	0.007482	0.000000
Actual	2003	0.070606	0.019163	0.064658	0.020743	0.000000	0.002359	0.000000
Actual	2004	0.071968	0.022278	0.065266	0.023583	0.000000	0.002283	0.000000
Actual	2005	0.085325	0.014803	0.070596	0.023390	0.000590	0.008881	0.000000
Actual	2006	0.093321	0.027332	0.076718	0.006895	0.002960	0.003690	0.000000
Actual	2007	0.104635	0.016818	0.086005	0.013333	0.017263	0.007328	0.000000
Actual	2008	0.093089	0.038769	0.097085	0.011653	0.000000	0.007528	0.000000
Actual	2009	0.093142	0.020760	0.127513	0.021542	0.000000	0.009574	0.000000
Actual	2010	0.084228	0.023722	0.106947	0.024915	0.000000	0.004550	0.000000
Forecast	2011	0.084228	0.023722	0.114145	0.023229	0.000000	0.004550	0.000000
Forecast	2012	0.084228	0.023722	0.121828	0.023229	0.000000	0.004550	0.000000
Forecast	2013	0.084228	0.023722	0.130028	0.023229	0.000000	0.004550	0.000000

	<u>t</u> <u>Fiscal</u>	<u>Int. Land</u> <u>Millions</u>	<u>Int. STIP</u> <u>Millions</u>	<u>Int. Trust</u> <u>Millions</u>	<u>Timber</u> <u>Millions</u>	<u>Res. Dev.</u> <u>Millions</u>	<u>TLMD Adm.</u> <u>Millions</u>
Actual	2000	0.000000	0.000086	0.154047	0.000000	-0.004521	
Actual	2001	0.000000	0.000000	0.161698	0.000000	-0.006864	
Actual	2002	0.000000	0.000000	0.173729	0.000000	-0.005450	
Actual	2003	0.000000	0.000000	0.192247	0.000000	-0.005326	
Actual	2004	0.000000	0.000000	0.214407	0.000000	-0.005561	
Actual	2005	0.000000	0.000000	0.218058	0.000000	-0.006300	
Actual	2006	0.000000	0.000000	0.191952	0.000000	-0.005931	
Actual	2007	0.000000	0.000000	0.204540	0.000000	-0.007108	
Actual	2008	0.000000	0.000000	0.193741	0.000000	-0.007043	
Actual	2009	0.000000	0.000000	0.174961	0.000000	-0.007660	
Actual	2010	0.000000	0.000000	0.177042	0.000000	0.000000	-0.158254
Forecast	2011	0.000000	0.000000	0.166028	0.000000	0.000000	-0.157670
Forecast	2012	0.000000	0.000000	0.173707	0.000000	0.000000	-0.165591
Forecast	2013	0.000000	0.000000	0.183112	0.000000	0.000000	-0.166104

Total Rev. = Grazing + Agriculture + O&G Lease + O&G Bonus + O&G Penalty + Misc. +  
Int. Land + Int. Stip + Int. Trust + Timber + Res. Dev.+TLMD Adm.

# Legislative Fiscal Division

## Revenue Estimate Profile

### Pine Hills Interest and Income

**Revenue Projection:**

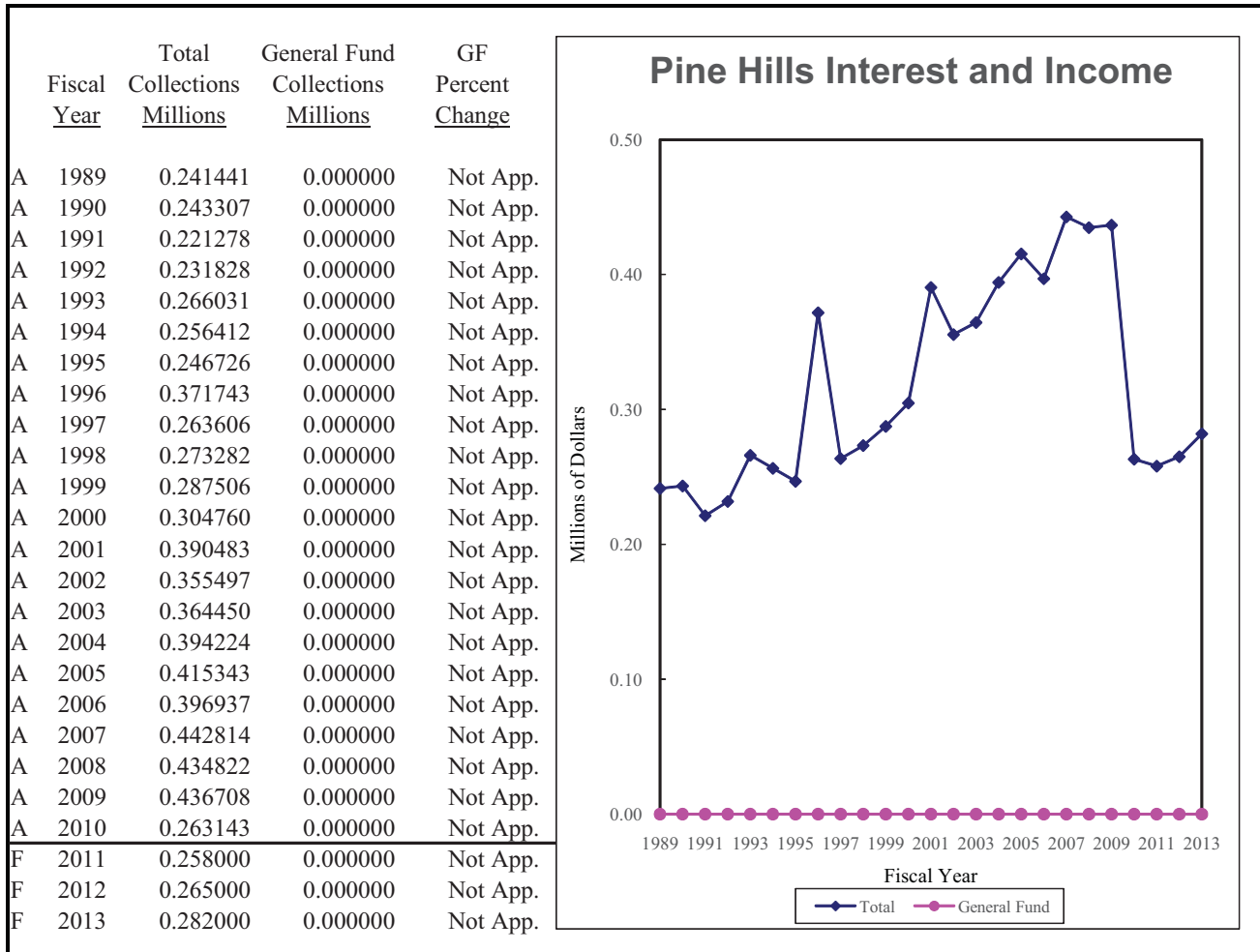

**Data Source(s):** Board of Investments, SABHRS, *Wall Street Journal*, IHS, Department of Natural Resources and Conservation

**Contacts:** Department of Natural Resources and Conservation



---

# Legislative Fiscal Division

## Revenue Estimate Profile

### Regional Water Trust Interest

---

**Revenue Description:** The 1999 Legislature (Senate Bill 220) created the Treasure State Endowment (TSE) Regional Water System Fund within the permanent coal tax trust fund. The fund receives 12.5% of total coal severance tax collections through June 2016. Interest earned on the fund is used to provide matching funds to plan and construct regional drinking water systems in Montana and fund state and local entity administrative expenses. Except for administrative expenses, each state dollar must be matched equally by local funds. The funds in the account are further restricted to finance regional drinking water systems from the waters of the Tiber reservoir and the Missouri River within specific geographic areas. The deposit of coal severance tax revenue to this fund terminates the end of FY 2016.

**Statutory Reference:**

Tax Rate – NA  
Distribution (MCA) – 17-5-703 (4b); use of earnings (90-6-715)  
Date Due (MCA) – monthly (17-5-703(4d))

**Applicable Tax Rate(s):** NA

**Distribution:** Interest earnings are deposited to a state special revenue fund and appropriated to the Department of Natural Resources and Conservation to fund eligible projects and pay administrative expenses.

Distribution Chart:

**State Special Revenue Fund**

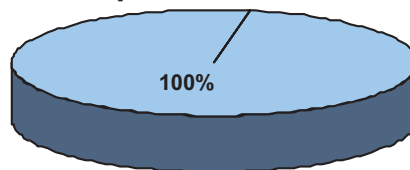

**Collection Frequency:** Monthly

**% of Total General Fund Revenue:** N/A

**Revenue Estimate Methodology:**

Data

The data used to estimate interest earnings from the regional water trust are obtained from the Board of Investments (BOI), IHS, and the state accounting system (SABHRS). The BOI provides information on historic interest rates as well as the gains and losses from the sale of securities. Projections of future interest rates are provided by IHS and historic interest collections are obtained from SABHRS.

Analysis

The regional water trust was created from distributions of the coal severance tax. The regional water trust was formed in 2000 as a sub-trust to the permanent coal trust. The Constitution requires that 50% of the coal severance tax collections be distributed to the coal trust, and 25% of that distribution (after the water bond debt service obligation is met) or 12.5% of total coal severance tax revenues is distributed to the regional water trust. The principal or corpus of the regional water trust now stands at \$56.3 million. Estimates of future deposits to the trust are developed in the coal severance tax projection and are expected to be \$5.8 million in FY 2009, \$5.8 million in FY 2010, and \$5.9 million in FY 2011.

# Legislative Fiscal Division

## Revenue Estimate Profile

### Regional Water Trust Interest

To forecast the regional water trust interest earnings, each of three interest/income components are estimated independently and combined. The estimated interest/income components include:

- Trust fund bond pool (TFBP)
- Short-term investment pool (STIP)
- New trust deposits

The TFBP was formed in 1995 to manage the fixed investments held in the state’s major trust funds. Each trust owns “shares” of the pool and interest earnings are paid to each trust on a per-share basis. TFBP earnings are the largest source of earnings for the trust, as shown in the figure below. To estimate TFBP earnings, the base year (FY 2010) rate of return generated by the pool, as reported by the BOI, is adjusted during the forecast period for maturing securities. The applicable long-term rate for these securities is based on an average of four long-term rates projected by IHS. The fiscal year average long-term interest rate is expected to be 4.2% in FY 2011, 4.2% in FY 2012, and 5.0% in FY 2013.

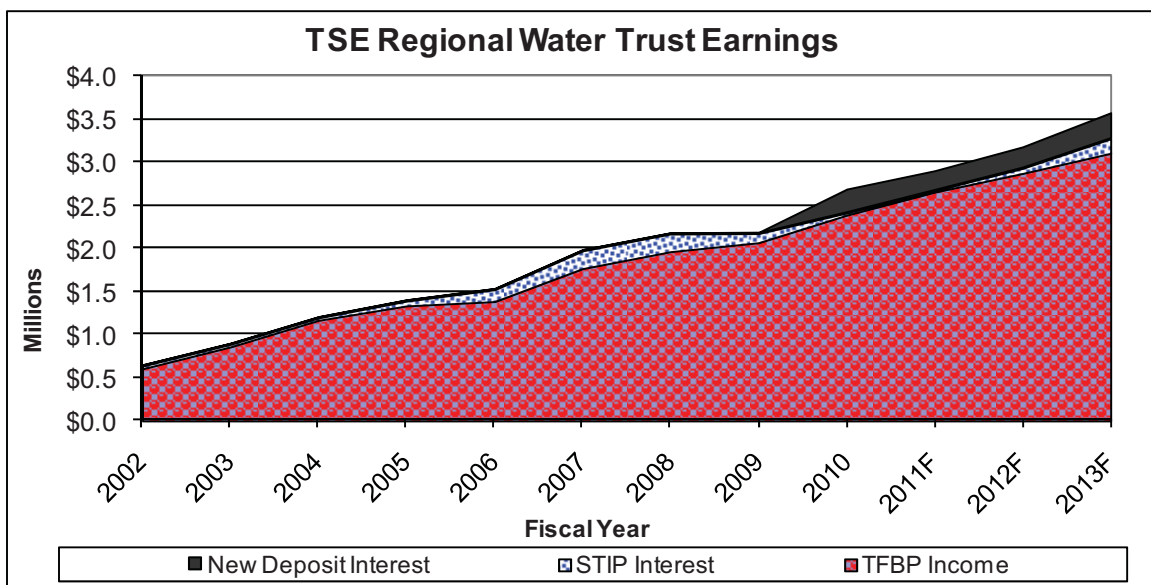

STIP interest (including other interest) is earned on cash, prior to investment in long-term investments. Funds are acquired from new deposits and/or maturing securities forecast period. Funds are held in STIP until the BOI determines that conditions are favorable for investment in the TFBP. To estimate future STIP earnings, an average short-term interest rate is developed, based on IHS projections of three short-term investments. The average fiscal year short-term interest rate is expected to be 0.3% in FY 2011, 0.9% in FY 2012, and 2.5% in FY 2013.

Coal severance tax distributions to the regional water trust are considered new deposits. New deposits are transferred to the trust on a quarterly basis. When the BOI receives the coal tax transfer, the funds are immediately invested in STIP. Funds are expected to remain in STIP for one month before being invested in the TFBP. The interest earned on new deposits is estimated by summing STIP earnings for one month with TFBP earnings for the remainder of the year.

# Legislative Fiscal Division

## Revenue Estimate Profile

### Regional Water Trust Interest

**Forecast Methodology:**

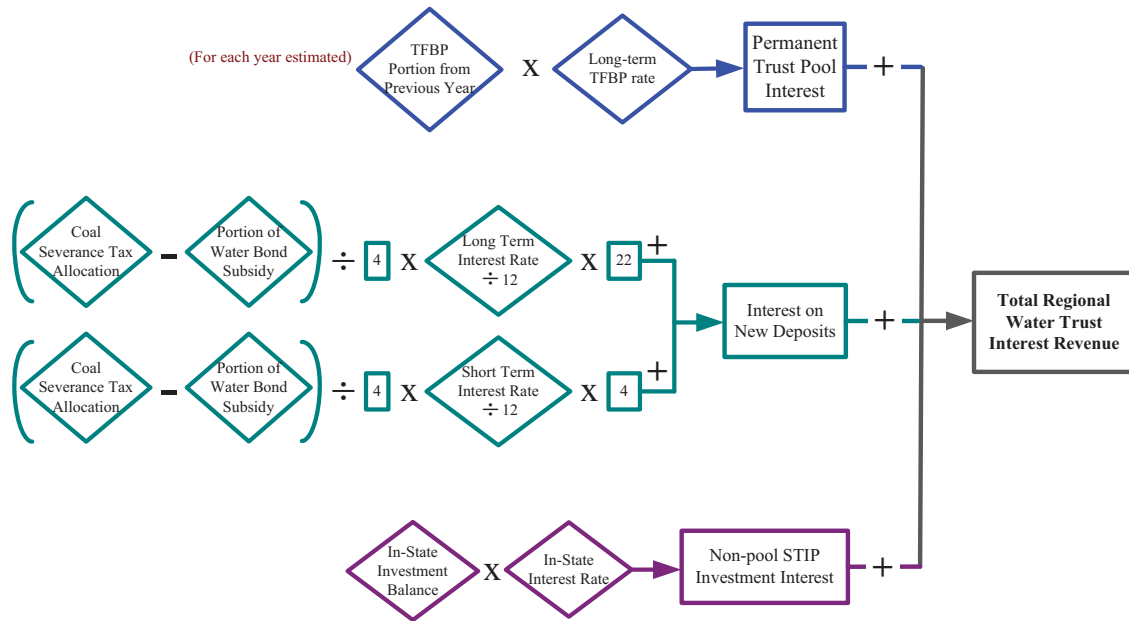

# Legislative Fiscal Division

## Revenue Estimate Profile

### Regional Water Trust Interest

#### Revenue Estimate Assumptions:

	t	Total Rev.	GF Rev.	TFBP	STIP	Loan	Invested	Average
	<u>Fiscal</u>	<u>Millions</u>	<u>Millions</u>	<u>Millions</u>	<u>Millions</u>	<u>Millions</u>	<u>Millions</u>	<u>Rate</u>
Actual	2000	0.032058	0.000000					
Actual	2001	0.370163	0.000000					
Actual	2002	0.643133	0.000000	0.610527	0.032606	0.000000		
Actual	2003	0.894258	0.000000	0.864661	0.029598	0.000000		
Actual	2004	1.201061	0.000000	1.173660	0.027401	0.000000	20.942460	0.057351
Actual	2005	1.396302	0.000000	1.340362	0.055941	0.000000	24.913396	0.056046
Actual	2006	1.527443	0.000000	1.390830	0.136614	0.000000	30.573159	0.049960
Actual	2007	1.978817	0.000000	1.772345	0.206472	0.000000	36.505390	0.054206
Actual	2008	2.174930	0.000000	1.969567	0.205364	0.000000	43.857799	0.049591
Actual	2009	2.178868	0.000000	2.073415	0.105454	0.000000	51.592794	0.042232
Actual	2010	2.418823	0.000000	2.393405	0.025417	0.000000	56.059781	0.043147
Forecast	2011	2.778000	0.000000	2.659686	0.118141	0.000000	61.211781	0.045381
Forecast	2012	3.048000	0.000000	2.876791	0.171232	0.000000	66.831781	0.045607
Forecast	2013	3.423000	0.000000	3.110527	0.312796	0.000000	72.538781	0.047193

	t	Net Coal Tax	New Deposit	Non Pool	Non Pool
	<u>Fiscal</u>	<u>New Deposit</u>	<u>Long Term</u>	<u>STIP</u>	<u>STIP Bal</u>
		<u>Millions</u>	<u>Rate</u>	<u>Rate</u>	<u>Millions</u>
Actual	2000	4.433724	6.3380%	5.4290%	3.441977
Actual	2001	4.042147	6.8850%	4.7390%	0.845223
Actual	2002	3.951756	6.3380%	2.5650%	1.578601
Actual	2003	3.677943	5.7290%	1.3600%	1.894047
Actual	2004	3.943085	5.3650%	1.2650%	2.693965
Actual	2005	4.704314	5.1940%	2.3870%	2.765447
Actual	2006	4.477691	5.2340%	4.0770%	3.825680
Actual	2007	5.094842	5.4050%	4.7290%	3.908386
Actual	2008	5.666484	5.3180%	3.1650%	5.610920
Actual	2009	6.195515	5.1210%	0.9770%	6.785915
Actual	2010	5.522179	4.7440%	0.2120%	5.487902
Forecast	2011	5.152000	4.2140%	0.2500%	5.487902
Forecast	2012	5.620000	4.1590%	0.9150%	5.487902
Forecast	2013	5.707000	5.0340%	2.5430%	5.487902

Total Rev. = Invested Balance × Average Return

# Legislative Fiscal Division

## Revenue Estimate Profile

### Regional Water Trust Interest

**Revenue Projection:**

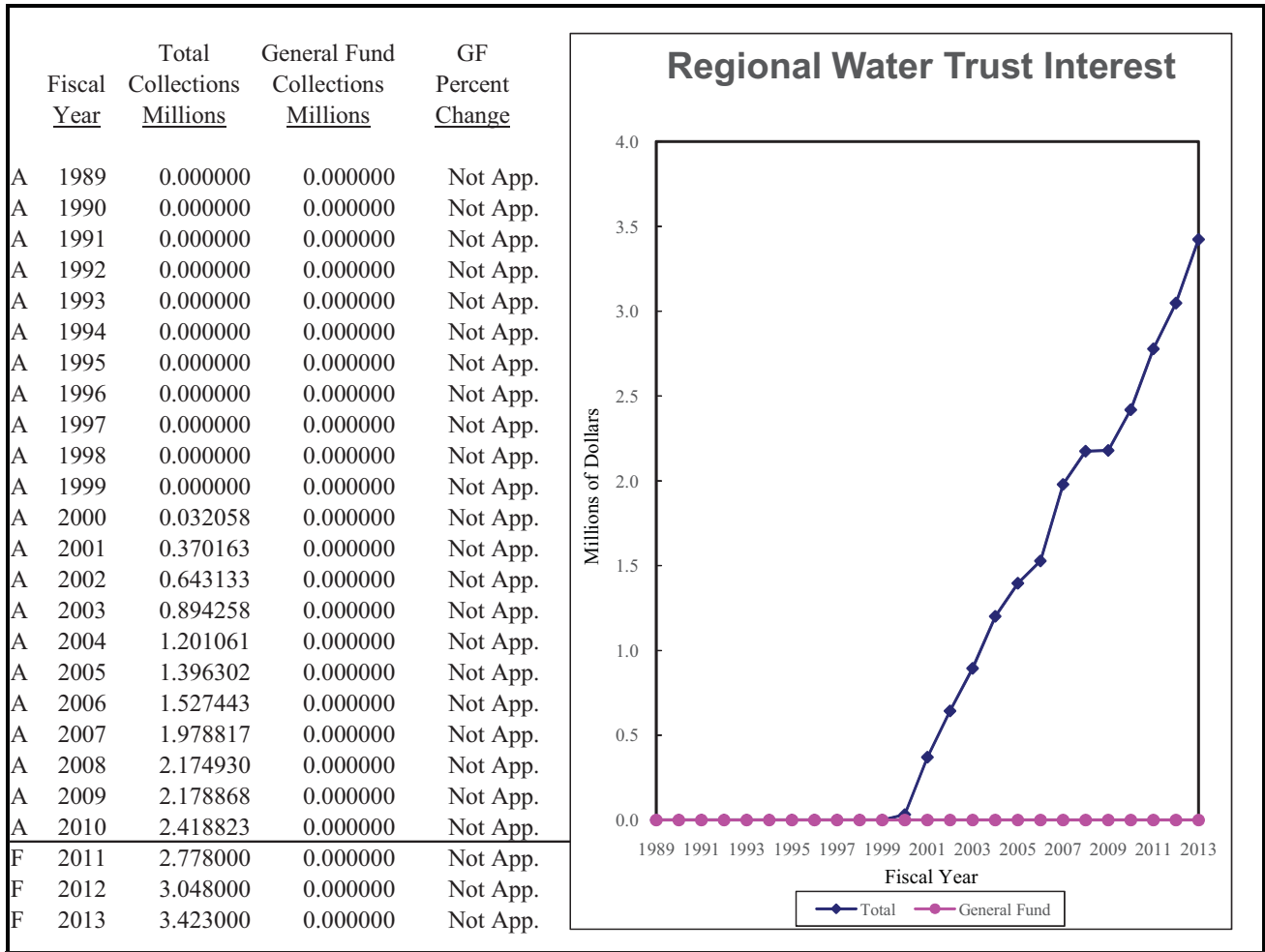

**Data Source(s):** Board of Investments, SABHRS, *Wall Street Journal*, IHS

**Contacts:**

---

# Legislative Fiscal Division

## Revenue Estimate Profile

### Resource Indemnity Trust Interest

---

**Revenue Description:** Article IX, Section 2 of the Montana Constitution and Title 15, Chapter 38, MCA, requires that certain resource extraction taxes, as determined by the legislature, be placed in a trust. The principal of the Resource Indemnity Trust (RIT) "shall forever remain inviolate in an amount of one hundred million dollars (\$100,000,000), guaranteed by the state against loss or diversion." Once the principal of the trust reaches \$100 million, any additional tax deposits may be appropriated. Interest earnings on the RIT are to be spent to improve the total environment and rectify damage to the environment. It is also the legislature's intent that the use of interest earnings for operations of state government be minimized.

On July 1, 2002 the Governor by executive order certified to the Secretary of State that the RIT balance had reached \$100 million. In prior years, the RIT had received revenue from the resource indemnity and ground water assessment tax and the oil and gas tax. Because these allocations of revenue are no longer deposited to the trust, the trust balance will remain constant and interest earnings will be dependent only on the interest rates.

#### **Statutory Reference:**

Tax Rate – NA

Distribution (MCA) – Montana Constitution, Article IX, Section 2; 15-38-202(2), use of earnings (15-38-203)

Date Due – NA

**Applicable Tax Rate(s):** N/A

**Distribution:** Statute allocates RIT interest earnings in the following manner:

- 1) at the beginning of the biennium, an amount not to exceed \$50,000 to the oil and gas mitigation account to bring the balance up to \$200,000. Money in this account is statutorily appropriated to the Board of Oil and Gas Conservation for the cost of plugging wells that have been abandoned and for which no responsible party can be found;
- 2) at the beginning of the biennium, \$500,000 to the water storage state special revenue account to provide loans and grants for water storage projects;
- 3) at the beginning of the biennium, \$175,000 to the environmental contingency fund which is statutorily appropriated upon authorization of the Governor for unanticipated public needs arising from certain disasters and emergencies;
- 4) \$3.5 million annually to the natural resources projects state special revenue account for distribution as grants;
- 5) \$300,000 annually to the ground water assessment account to improve ground water management and protection;
- 6) \$500,000 annually to the future fisheries program for bull trout and cutthroat trout recovery; and
- 7) of the remaining RIT interest earnings: a) 65% to the natural resources operations state special revenue account for program and administrative costs; b) 26% to the hazardous waste/CERCLA state special revenue account for superfund activities; and c) 9% to the environmental quality protection state special revenue fund for additional clean-up activities.

The Department of Natural Resources and Conservation administers two of the RIT interest accounts which are used for grants, loans, and administrative costs: the renewable resource grant and loan program account and the reclamation and development grant account. These accounts also receive funding from other sources. All grants and loans made from these accounts require legislative approval. Grants must also be appropriated.

# Legislative Fiscal Division

## Revenue Estimate Profile

### Resource Indemnity Trust Interest

Distribution Chart:

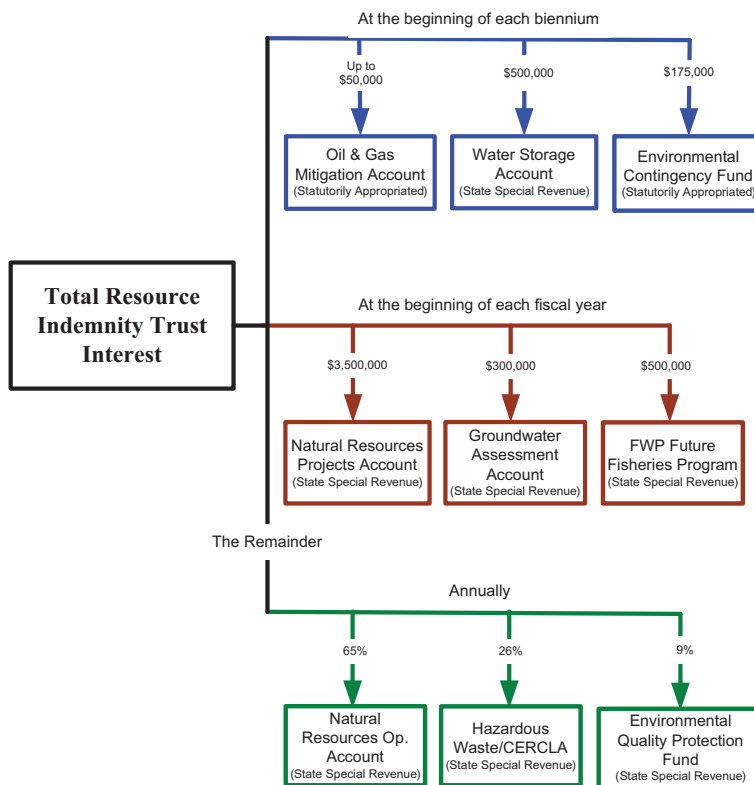

**Collection Frequency:** Monthly

**% of Total General Fund Revenue:** N/A

**Revenue Estimate Methodology:**

Data

The data used to estimate interest earnings from the resource indemnity (RIT) trust are obtained from the Board of Investments (BOI), IHS, and the state accounting system (SABHRS). The BOI provides information on historic interest rates as well as the gains and losses from the sale of securities. Projections of future interest rates are provided by IHS and historic interest collections are obtained from SABHRS.

Analysis

The RIT trust, formed in the mid 1970's, was created from distributions of the resource indemnity and ground water assessment tax (RIGWA) and the oil and gas tax. The resource indemnity trust reached its constitutionally required principal of \$100 million in FY 2002. As a result, the trust no longer receives new income from tax distributions. The principal or corpus of the resource indemnity trust now stands at \$100 million, as shown by the line in the figure below. No new deposits are anticipated for the trust.

To forecast the resource indemnity trust interest earnings, each of the following three interest/income components are estimated independently and combined:

- Trust funds bond pool (TFBP)
- Short-term investment pool (STIP)
- New trust deposits (if anticipated)

# Legislative Fiscal Division

## Revenue Estimate Profile

### Resource Indemnity Trust Interest

The TFBP was formed in 1995 to manage the fixed investments held in the state’s major trust funds. Each trust owns “shares” of the pool and interest earnings are paid to each trust on a per-share basis. TFBP earnings are the largest source of earnings for the trust, as shown in the figure below. To estimate TFBP earnings, the base year (FY 2010) rate of return generated by the pool, as reported by the BOI, is adjusted during the forecast period for maturing securities. The applicable long-term rate for these securities is based on a two-year average of four long-term rates projected by IHS. The fiscal year long-term rate is estimated to be 4.2%, 4.2%, and 5.0% for FY 2011 through 2013, respectively. The applicable rates are multiplied by the trust balance to determine earnings.

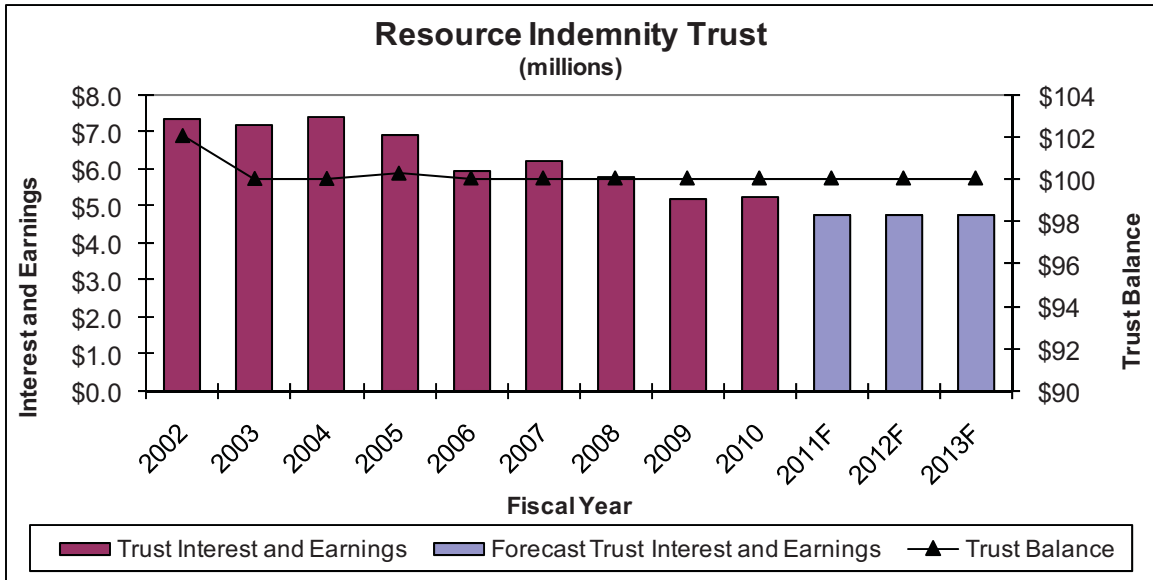

STIP interest (including other interest) is earned on cash, prior to investment in long-term investments. Funds are acquired from new deposits and/or maturing securities in the forecast period. Funds are held in STIP until the BOI determines that conditions are favorable for investment in the TFBP. To estimate future STIP earnings, an average short-term interest rate is developed, based on IHS projections of three short-term investments. Because no new deposits are anticipated for the trust, STIP earnings are projected for only non-pool balances estimated at the FY 2010 amount.



# Legislative Fiscal Division

## Revenue Estimate Profile

### Resource Indemnity Trust Interest

**Forecast Methodology:**

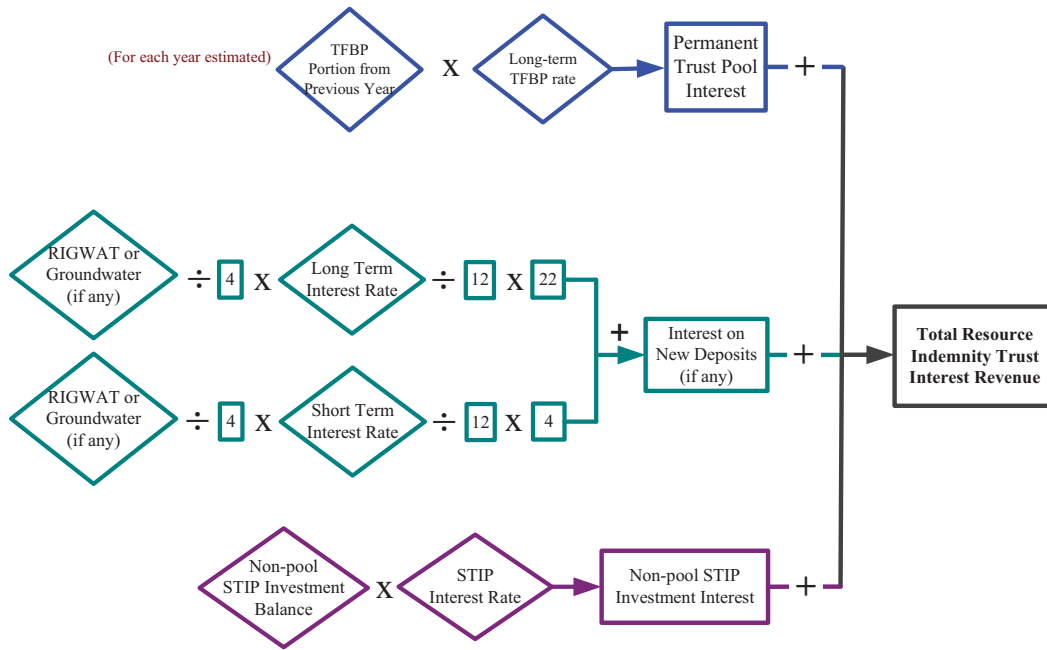

**Legislative Fiscal Division**  
**Revenue Estimate Profile**  
**Resource Indemnity Trust Interest**

**Revenue Estimate Assumptions:**

	t	Total Rev.	GF Rev.	TFBP	STIP	Invested	Average
	<u>Fiscal</u>	<u>Millions</u>	<u>Millions</u>	<u>Interest</u>	<u>Interest</u>	<u>Balance</u>	<u>Return</u>
				<u>Millions</u>	<u>Millions</u>	<u>Millions</u>	<u>Rate</u>
Actual	2000	9.184060	0.000000				
Actual	2001	7.305993	0.000000				
Actual	2002	7.320563	0.000000	7.286083	0.034480		
Actual	2003	7.174342	0.000000	7.161271	0.013072		
Actual	2004	7.380242	0.000000	7.375168	0.005073	100.644275	0.073330
Actual	2005	6.247097	0.000000	6.889636	0.012289	100.909672	0.068397
Actual	2006	5.915563	0.000000	5.896878	0.018684	100.506457	0.058858
Actual	2007	6.220240	0.000000	6.197611	0.022629	100.722508	0.061756
Actual	2008	5.800854	0.000000	5.785649	0.015204	100.503825	0.057718
Actual	2009	5.197073	0.000000	5.191090	0.005983	100.484101	0.051720
Actual	2010	5.212968	0.000000	5.211683	0.001286	100.434134	0.051904
Forecast	2011	4.743000	0.000000	4.741199	0.001389	100.434134	0.047221
Forecast	2012	4.746000	0.000000	4.741199	0.004732	100.434134	0.047254
Forecast	2013	4.755000	0.000000	4.741199	0.013372	100.434134	0.047340

	t	Net Tax	New Deposit	Non Pool	Non Pool
	<u>Fiscal</u>	<u>New Deposit</u>	<u>Long Term</u>	<u>STIP</u>	<u>STIP Bal</u>
		<u>Millions</u>	<u>Rate</u>	<u>Rate</u>	<u>Millions</u>
Actual	2000	3.391472	6.3380%	5.4290%	3.712675
Actual	2001	2.205880	6.8850%	4.7390%	1.557391
Actual	2002	1.588631	6.3380%	2.5650%	2.175871
Actual	2003	0.000000	5.7290%	1.3600%	0.740511
Actual	2004	-0.000188	5.3650%	1.2650%	0.644299
Actual	2005	0.252454	5.1940%	2.3870%	0.909696
Actual	2006	0.000000	5.2340%	4.0770%	0.506481
Actual	2007	0.000000	5.4050%	4.7290%	0.722532
Actual	2008	0.000000	5.3180%	3.1650%	0.503849
Actual	2009	0.000000	5.1210%	0.9770%	0.484125
Actual	2010	0.000000	4.7440%	0.2120%	0.434158
Forecast	2011	0.000000	4.2140%	0.2500%	0.434158
Forecast	2012	0.000000	4.1590%	0.9150%	0.434158
Forecast	2013	0.000000	5.0340%	2.5430%	0.434158

**Legislative Fiscal Division**  
**Revenue Estimate Profile**  
**Resource Indemnity Trust Interest**

	t	Hazardous Waste	Environmental Quality	Renewable Resource	Reclamation Development	Environmental Contingency
	<u>Fiscal</u>	<u>Millions</u>	<u>Millions</u>	<u>Millions</u>	<u>Millions</u>	<u>Millions</u>
Actual	2000	0.941319	0.319852	3.721445	3.176444	0.175000
Actual	2001	0.796322	0.274126	3.259425	2.676120	0.000000
Actual	2002	0.534446	0.185001	3.356669	2.219447	0.175000
Actual	2003	0.678555	0.231326	3.026507	2.587954	0.000000
Actual	2004	0.564353	0.192393	2.894137	2.354359	0.175000
Actual	2005	0.474561	0.161782	2.790060	2.170694	0.000000
Actual	2006	0.169146	0.058551	2.435169	1.727697	0.175000
Actual	2007	0.436862	0.151222	2.744072	2.088084	0.000000
Actual	2008	0.201722	0.069827	0.000000	0.000000	0.175000
Actual	2009	0.187739	0.064987	0.000000	0.000000	0.175000
Actual	2010	0.048872	0.016917	0.000000	0.000000	0.175000
Forecast	2011	0.069680	0.024120	0.000000	0.000000	0.175000
Forecast	2012	0.070460	0.024390	0.000000	0.000000	0.175000
Forecast	2013	0.072800	0.025200	0.000000	0.000000	0.175000

	t	Water Storage	Oil & Gas Receipts	FWP Receipts	Groundwater Receipts	NR Operation Receipts	NR Projects Receipts
	<u>Fiscal</u>	<u>Millions</u>	<u>Millions</u>	<u>Millions</u>	<u>Millions</u>	<u>Millions</u>	<u>Millions</u>
Actual	2000	0.500000	0.050000	0.000000	0.300000	0.000000	0.000000
Actual	2001	0.000000	0.000000	0.000000	0.300000	0.000000	0.000000
Actual	2002	0.500000	0.050000	0.000000	0.300000	0.000000	0.000000
Actual	2003	0.000000	0.000000	0.350000	0.300000	0.000000	0.000000
Actual	2004	0.500000	0.050000	0.350000	0.300000	0.000000	0.000000
Actual	2005	0.000000	0.000000	0.350000	0.300000	0.000000	0.000000
Actual	2006	0.500000	0.050000	0.500000	0.300000	0.000000	0.000000
Actual	2007	0.000000	0.000000	0.500000	0.300000	0.000000	0.000000
Actual	2008	0.500000	0.050000	0.500000	0.300000	0.504305	3.500000
Actual	2009	0.000000	0.000000	0.500000	0.300000	0.469347	3.500000
Actual	2010	0.500000	0.050000	0.500000	0.300000	0.122179	3.500000
Forecast	2011	0.000000	0.000000	0.500000	0.300000	0.174200	3.500000
Forecast	2012	0.000000	0.000000	0.500000	0.300000	0.176150	3.500000
Forecast	2013	0.000000	0.000000	0.500000	0.300000	0.182000	3.500000

Total Rev. = Invested Balance × Average Return

# Legislative Fiscal Division

## Revenue Estimate Profile

### Resource Indemnity Trust Interest

**Revenue Projection:**

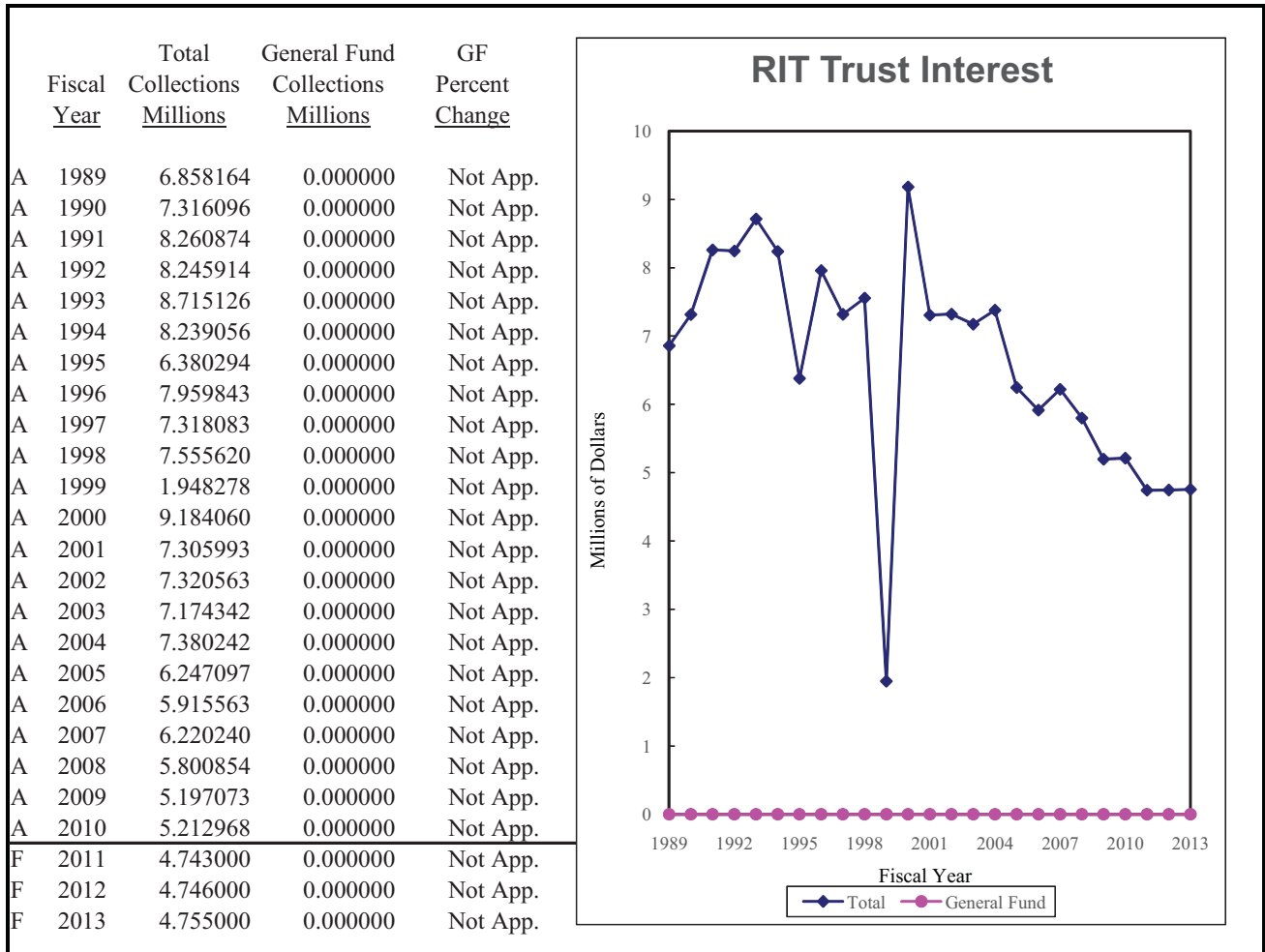

**Data Source(s):** Board of Investments, SABHRS, *Wall Street Journal*, IHS

**Contacts:**

---

# Legislative Fiscal Division

## Revenue Estimate Profile

### Tobacco Trust Interest

---

**Revenue Description:** Due to passage of Montana Constitutional Amendment 35 by the electorate in November 2000, the legislature is required to dedicate not less than 40% of tobacco settlement money to a permanent trust fund. Initially, the legislature did not determine the exact percentage to be deposited to the trust fund; the revenue estimate assumes 40%. Since the passage of Initiative 146 by the electorate in November 2002, 32% of the tobacco settlement money is to fund tobacco prevention and 17% is to fund the Children's Health Insurance Program. As amended in SB 485 by the 2003 legislature, money from these allocations can also be used to fund human services programs and to match federal Medicaid funds through FY 2005. The remaining 11% of the money is deposited to the general fund. Interest earnings from the trust can only be used for tobacco disease prevention programs and programs providing benefits, services, or coverage that are related to the health care needs of Montanans. HB 743 enacted by the 2007 Legislature added chronic disease programs to the definition of tobacco disease prevention programs. The earnings cannot be used to replace state or federal money used to fund tobacco disease prevention programs and state programs that existed on December 31, 1999, providing benefits, services, or coverage of the health care needs of Montanans.

#### Statutory Reference:

Tax Rate – NA

Distribution (MCA) – Montana Constitution Article XII, Section 4; 17-6-601; 17-6-603

Date Due – Interest deposits are mostly made monthly, but none in July and two in June

**Applicable Tax Rate(s):** NA

**Distribution:** Interest earnings from the trust fund are distributed:

1. 90% to a state special revenue account for appropriation by the legislature for disease prevention programs (include chronic disease programs) and state programs providing benefits, services, or coverage that are related to the health care needs of the people of Montana; and
2. 10% to the tobacco settlement trust fund.

#### Distribution Chart:

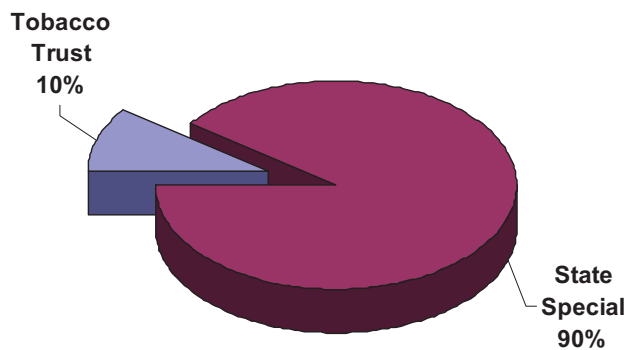

# Legislative Fiscal Division

## Revenue Estimate Profile

### Tobacco Trust Interest

**Collection Frequency:** Trust interest earnings are deposited monthly to the state special revenue account and the trust.

**% of Total General Fund Revenue:** N/A

**Revenue Estimate Methodology:**

Data

The data used to estimate interest earnings from the tobacco settlement trust are obtained from the Board of Investments (BOI), IHS, and the state accounting system (SABHRS). The BOI provides information on historic interest rates as well as the gains and losses from the sale of securities. Projections of future interest rates are provided by IHS and historic interest collections are obtained from SABHRS.

Analysis

The tobacco settlement trust, formed in 2000, was created from distributions of the tobacco settlement funds. In 2000, as required by constitutional amendment, the state began depositing 40% of the tobacco settlement funds into a trust. As required in statute, 10% of the trust earnings must be deposited in the trust. The principal or corpus of the tobacco trust now stands at \$122.0 million, as shown by the line in the figure below. New deposits are expected to be \$13.5 million in FY 2011, \$13.5 million in FY 2012, and \$13.6 million in FY 2013.

To forecast the tobacco settlement trust interest earnings, each of the following three interest/income components are estimated independently and combined:

- Trust funds bond pool (TFBP)
- Short-term investment pool (STIP)
- New trust deposits

The TFBP was formed in 1995 to manage the fixed investments held in the state’s major trust funds. Each trust owns “shares” of the pool and interest earnings are paid to each trust on a per-share basis. TFBP earnings are the largest source of earnings for the trust, as shown in the figure below. To estimate TFBP earnings, the base year (FY 2010) rate of return generated by the pool, as reported by the BOI, is adjusted during the forecast period for maturing securities. The applicable new long-term rate for these securities is based on an average of four long-term rates projected by IHS. The fiscal year average long-term interest rate is expected to be 4.2% in FY 2011, 4.2% in FY 2012, and 5.0% in FY 2013.

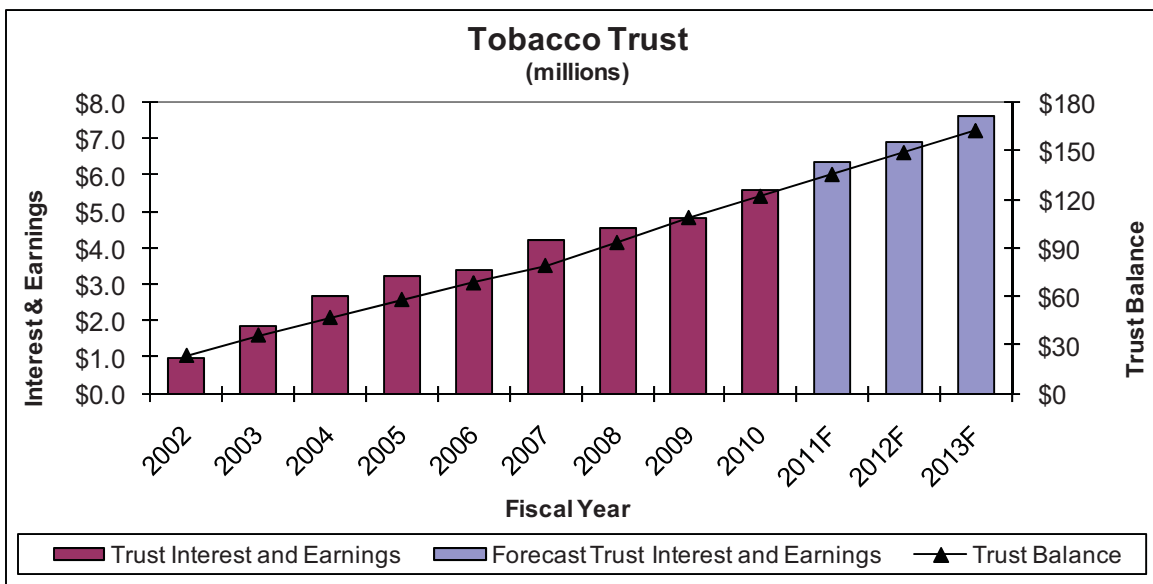

# Legislative Fiscal Division

## Revenue Estimate Profile

### Tobacco Trust Interest

STIP interest (including other interest) is earned on cash, prior to investment in long-term investments. Funds are acquired from new deposits and/or maturing securities in the forecast period. Funds are held in STIP until the BOI determines that conditions are favorable for investment in the TFBP. To estimate future STIP earnings, an average short-term interest rate is developed, based on IHS projections of three short-term investments. The average fiscal year short-term interest rate is expected to be 0.3% in FY 2011, 0.9% in FY 2012, and 2.5% in FY 2013.

The 40% distribution of tobacco settlement funds and 10% of retained interest earnings are considered new deposits in the tobacco settlement trust. New deposits are transferred to the trust on a quarterly basis. When the BOI receives the tobacco settlement funds, they are immediately invested in STIP. Funds are expected to remain in STIP for one month before being invested in the TFBP. The interest earned on new deposits is estimated by summing STIP earnings for one month with TFBP earnings for the remainder of the year.

#### Forecast Methodology:

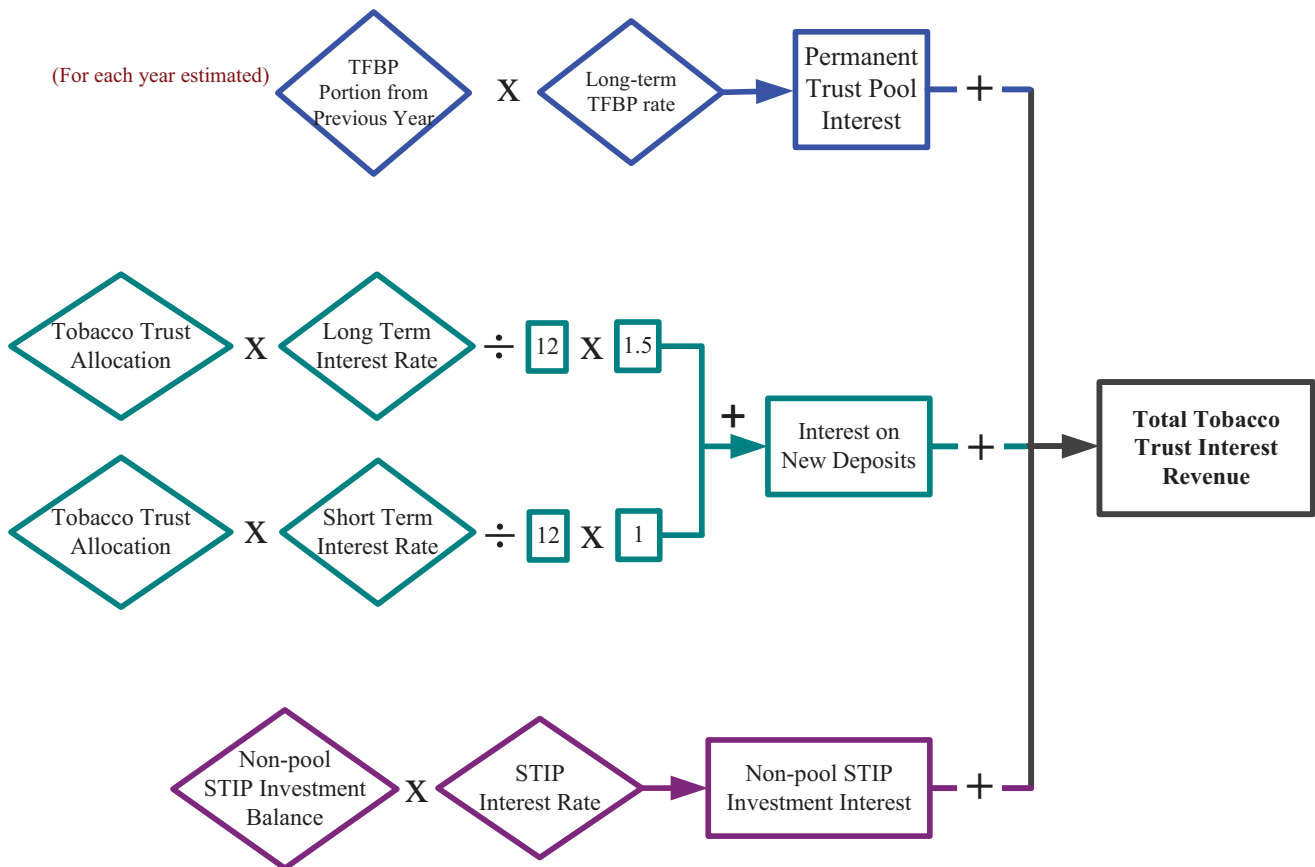

# Legislative Fiscal Division

## Revenue Estimate Profile

### Tobacco Trust Interest

#### Revenue Estimate Assumptions:

	t	Total Rev.	GF Rev.	TFBP	STIP	90 Percent	10 Percent
	Fiscal	Millions	Millions	Interest	Interest	Interest	Interest
				Millions	Millions	Millions	Millions
Actual	2000	0.000000	0.000000				
Actual	2001	0.239625	0.000000				
Actual	2002	0.967687	0.000000	0.955252	0.012435		
Actual	2003	1.830214	0.000000	1.816256	0.013958	1.647000	0.183000
Actual	2004	2.669829	0.000000	2.661875	0.007953	2.403000	0.267000
Actual	2005	3.202336	0.000000	3.165725	0.036611	2.882000	0.320000
Actual	2006	3.387527	0.000000	3.320678	0.066848	3.049000	0.339000
Actual	2007	4.208268	0.000000	4.156125	0.052144	3.787000	0.421000
Actual	2008	4.545661	0.000000	4.524575	0.021084	4.091000	0.455000
Actual	2009	4.825169	0.000000	4.817369	0.007800	4.343000	0.483000
Actual	2010	5.598645	0.000000	5.597074	0.001571	5.039000	0.560000
Forecast	2011	5.853000	0.000000	5.850407	0.003022	5.268000	0.585000
Forecast	2012	6.430000	0.000000	6.419409	0.011026	5.787000	0.643000
Forecast	2013	7.028000	0.000000	6.997788	0.030768	6.325000	0.703000

	t	Tobacco	New Deposit	Non Pool	Non Pool	Invested	Average
	Fiscal	New Deposit	Long Term	STIP	STIP Bal	Balance	Return
		Millions	Rate	Rate	Millions	Millions	Rate
Actual	2000	0.000000	6.3380%	5.4290%	0.000000		
Actual	2001	10.650750	6.8850%	4.7390%	0.249457		
Actual	2002	12.431607	6.3380%	2.5650%	0.584877		
Actual	2003	12.466407	5.7290%	1.3600%	0.251155		
Actual	2004	10.668829	5.3650%	1.2650%	0.132682	46.756485	0.057101
Actual	2005	10.828281	5.1940%	2.3870%	2.853978	57.902493	0.055306
Actual	2006	9.940413	5.2340%	4.0770%	0.916926	68.175043	0.049689
Actual	2007	10.324219	5.4050%	4.7290%	0.493197	79.001067	0.053269
Actual	2008	13.845710	5.3180%	3.1650%	0.536632	93.294404	0.048724
Actual	2009	15.009487	5.1210%	0.9770%	0.098121	108.775893	0.044359
Actual	2010	12.613175	4.7440%	0.2120%	0.064128	121.956900	0.045907
Forecast	2011	13.522000	4.2140%	0.2500%	0.064128	135.478900	0.043205
Forecast	2012	13.544000	4.1590%	0.9150%	0.064128	149.022900	0.043151
Forecast	2013	13.587000	5.0340%	2.5430%	0.064128	162.609900	0.043223

Total Rev. = Invested Balance × Average Return



# Legislative Fiscal Division

## Revenue Estimate Profile

### Tobacco Trust Interest

**Revenue Projection:**

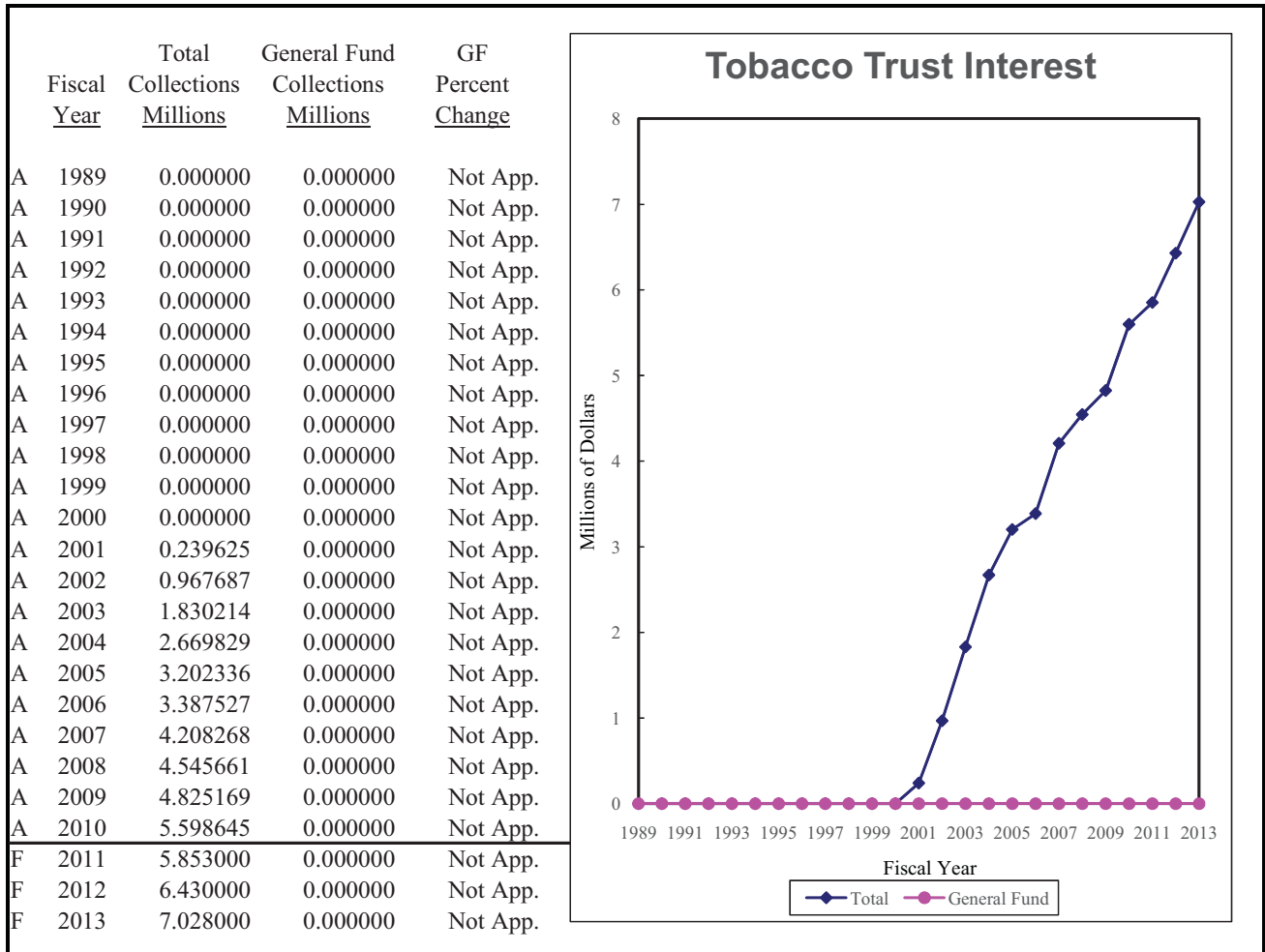

**Data Source(s):** Board of Investments, SABHRS, *Wall Street Journal*, IHS

**Contacts:** Department of Justice

---

# Legislative Fiscal Division

## Revenue Estimate Profile

### Treasure State Endowment Trust Interest

---

**Revenue Description:** In the June 1992 election, voters approved a referendum to create the Treasure State Endowment Fund (TSEF) within the permanent coal tax trust fund. The TSEF received a \$10 million grant from the permanent trust principal in FY 1994 and received 37.5% of total coal severance tax collections from July 1999 through June 2003. Beginning FY 2004, the trust receives 25% of total collections. Interest earned on the TSEF is used to finance local infrastructure projects, as prioritized by the departments of Commerce and Natural Resources and Conservation and authorized by the legislature via the Treasure State Endowment Program (TSEP).

**Statutory Reference:**

Tax Rate – NA  
Distribution (MCA) – 17-5-703 (4c); use of earnings (90-6-701(2))  
Date Due (MCA) – Monthly (17-5-703 (4c))

**Applicable Tax Rate(s):** N/A

**Distribution:** Interest earnings are allocated to the Department of Commerce to fund TSEP.

Distribution Chart:

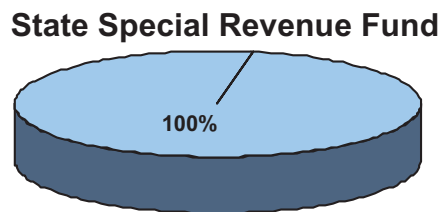

**Collection Frequency:** Monthly

**% of Total General Fund Revenue:** N/A

**Revenue Estimate Methodology:**

Data

The data used to estimate interest earnings from the treasure state endowment (TSE) trust is obtained from the Board of Investments (BOI), IHS, and the state accounting system (SABHRS). The BOI provides information on historic interest rates as well as the gains and losses from the sale of securities. Projections of future interest rates are provided by IHS and historic interest collections are obtained from SABHRS.

Analysis

The TSE trust was created from distributions of the coal severance tax. The TSE trust was formed early in the 1990's as a sub-trust to the permanent coal trust. The Constitution requires that 50% of the coal severance tax collections be distributed to the coal trust, and 50% of that distribution (after the water bond debt service obligation is met) or 25% of total coal severance tax revenues is distributed to the TSE trust. The principal or corpus of the TSE trust now stands at \$189.6 million. The estimates of future deposits to the TSE trust are developed in the coal severance tax projection and are expected to be \$11.5 million in FY 2010, \$11.6 million in FY 2012, and \$11.8 million in FY 2013.

# Legislative Fiscal Division

## Revenue Estimate Profile

### Treasure State Endowment Trust Interest

To forecast the TSE trust interest earnings, each of the following four interest/income components are estimated independently and combined:

- Trust funds bond pool (TFBP)
- In-state investments
- Short-term investment pool (STIP)
- New trust deposits

The TFBP was formed in 1995 to manage the fixed investments held in the state’s major trust funds. Each trust owns “shares” of the pool and interest earnings are paid to each trust on a per-share basis. TFBP earnings are the largest source of earnings for the trust, as shown in the figure below. To estimate TFBP earnings, the base year (FY 2010) rate of return generated by the pool, as reported by the BOI, is adjusted during the forecast period for maturing securities. The applicable new long-term rate for these securities is based on an average of four long-term rates projected by IHS. The fiscal year average long-term interest rate is expected to be 4.2% in FY 2010, 4.2% in FY 2012, and 5.0% in FY 2013.

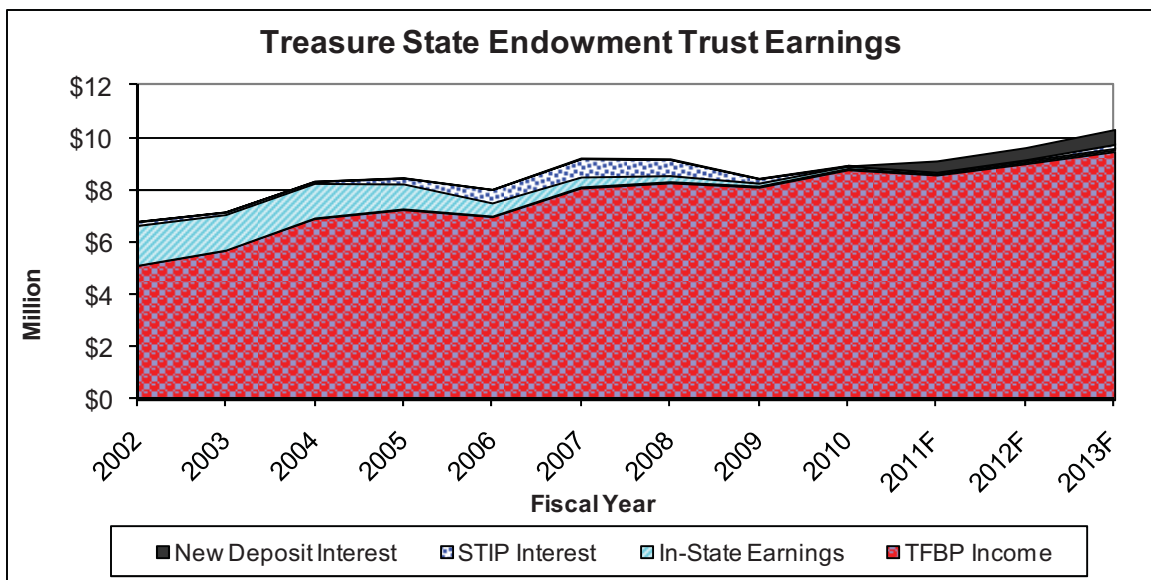

As seen in the figure above, earnings from in-state investments have historically been the second largest source of income to the TSE trust. The BOI is required by statute to invest 25% of coal tax trust in the Montana economy. Investments must be made to maximize the long-term benefit to the Montana economy. In-state investments primarily consist of loans to Montana business entities and earnings are equal to the interest charged on the loans. In the 2013 biennium, the average loan rate is forecast to be 4.5%.

STIP interest (including other interest) is earned on cash, prior to investment in long-term investments. Funds are acquired from new deposits and/or maturing securities in the forecast period. Funds are held in STIP until the BOI determines that conditions are favorable for investment in the TFBP. To estimate future STIP earnings, an average short-term interest rate is developed, based on IHS projections of three short-term investments. The average of these rates is then converted to a fiscal year basis. The average fiscal year short-term interest rate is expected to be 0.3% in FY 2011, 0.9% in FY 2012, and 2.5% in FY 2013.

Coal severance tax distributions to the TSE trust are considered new deposits. New deposits are transferred to the trust on a quarterly basis. When the BOI receives the coal tax transfer, the funds are immediately invested in STIP. Funds are expected to remain in STIP for one month before being invested in the TFBP. The interest earned on new deposits is estimated by summing STIP earnings for one month with TFBP earnings for the remainder of the year.

# Legislative Fiscal Division

## Revenue Estimate Profile

### Treasure State Endowment Trust Interest

**Forecast Methodology:**

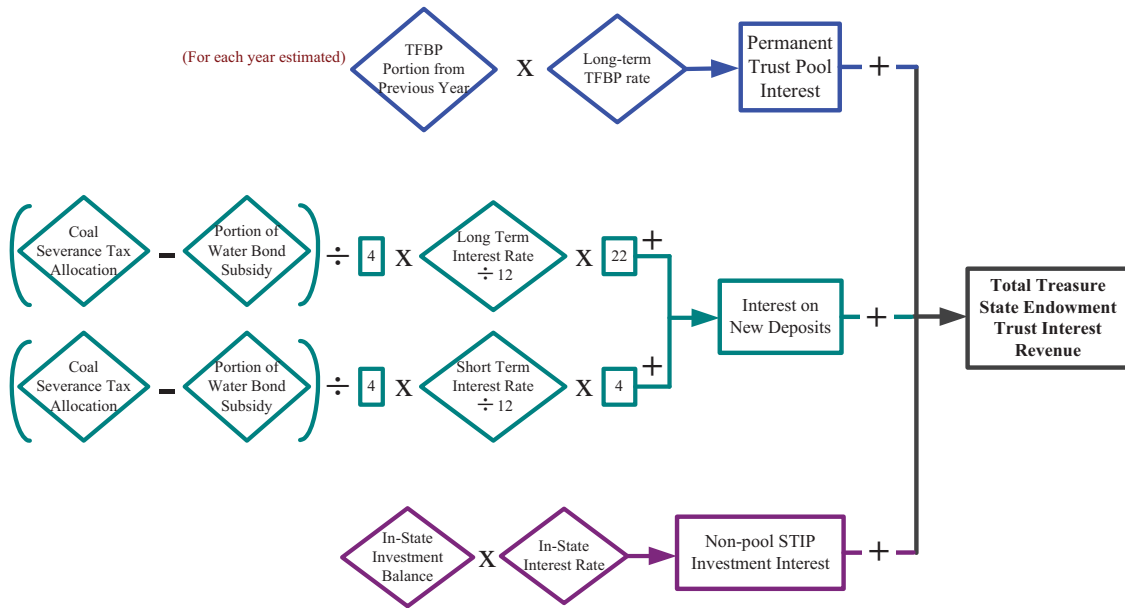

**Legislative Fiscal Division**  
**Revenue Estimate Profile**  
**Treasure State Endowment Trust Interest**

**Revenue Estimate Assumptions:**

	t	Total Rev.	GF Rev.	TFBP	STIP	Loan	Invested	Average
	<u>Fiscal</u>	<u>Millions</u>	<u>Millions</u>	<u>Millions</u>	<u>Millions</u>	<u>Millions</u>	<u>Millions</u>	<u>Return</u>
				Interest	Interest	Interest	Balance	Rate
				<u>Millions</u>	<u>Millions</u>	<u>Millions</u>	<u>Millions</u>	
Actual	2000	5.123374	0.000000					
Actual	2001	5.801525	0.000000					
Actual	2002	6.804839	0.000000	5.139577	0.134725	1.530537		
Actual	2003	7.175069	0.000000	5.718544	0.091977	1.364547		
Actual	2004	8.349481	0.000000	6.929583	0.085931	1.333115	127.175885	0.065653
Actual	2005	8.481564	0.000000	7.272317	0.236790	0.970369	137.335617	0.061758
Actual	2006	8.038515	0.000000	7.001103	0.514071	0.523204	147.150621	0.054628
Actual	2007	9.224883	0.000000	8.101840	0.719283	0.403746	161.366192	0.057167
Actual	2008	9.194019	0.000000	8.296236	0.638806	0.258977	172.310051	0.053357
Actual	2009	8.450476	0.000000	8.131233	0.181984	0.140945	177.724300	0.047548
Actual	2010	8.939751	0.000000	8.799064	0.026487	0.117515	188.798137	0.047351
Forecast	2011	8.926000	0.000000	8.593297	0.245980	0.090269	200.416137	0.044538
Forecast	2012	9.484000	0.000000	9.082880	0.314403	0.090269	212.982137	0.044531
Forecast	2013	10.198000	0.000000	9.605500	0.505976	0.090269	225.744137	0.045177

	t	Net Coal Tax	New Deposit	Non Pool	Non Pool	Non Pool	Non Pool
	<u>Fiscal</u>	<u>New Deposit</u>	<u>Long Term</u>	<u>STIP</u>	<u>Loan</u>	<u>STIP Bal</u>	<u>Loan Bal</u>
		<u>Millions</u>	<u>Rate</u>	<u>Rate</u>	<u>Rate</u>	<u>Millions</u>	<u>Millions</u>
Actual	2000	13.301172	7.0160%	5.4290%	0.0000%	12.385400	0.000000
Actual	2001	12.126440	6.8850%	4.7390%	0.0000%	4.384216	19.223452
Actual	2002	11.855268	6.3380%	2.5650%	8.2549%	7.426826	17.858672
Actual	2003	11.033830	5.7290%	1.3600%	7.4418%	11.674509	18.813738
Actual	2004	7.886171	5.3650%	1.2650%	8.2678%	10.526991	13.434570
Actual	2005	9.408628	5.1940%	2.3870%	8.7756%	12.141430	8.680571
Actual	2006	8.955381	5.2340%	4.0770%	7.1089%	11.708362	6.039199
Actual	2007	10.189685	5.4050%	4.7290%	7.4842%	14.763620	4.750104
Actual	2008	11.332968	5.3180%	3.1650%	7.5444%	14.042401	2.115350
Actual	2009	12.391030	5.1210%	0.9770%	7.3364%	6.445018	1.726982
Actual	2010	11.044359	4.7440%	0.2120%	7.1476%	5.989605	1.561232
Forecast	2011	11.618000	4.2140%	0.2500%	5.7819%	5.989605	1.561232
Forecast	2012	12.566000	4.1590%	0.9150%	5.7819%	5.989605	1.561232
Forecast	2013	12.762000	5.0340%	2.5430%	5.7819%	5.989605	1.561232

Total Rev. = Invested Balance × Average Return

# Legislative Fiscal Division

## Revenue Estimate Profile

### Treasure State Endowment Trust Interest

#### Revenue Projection:

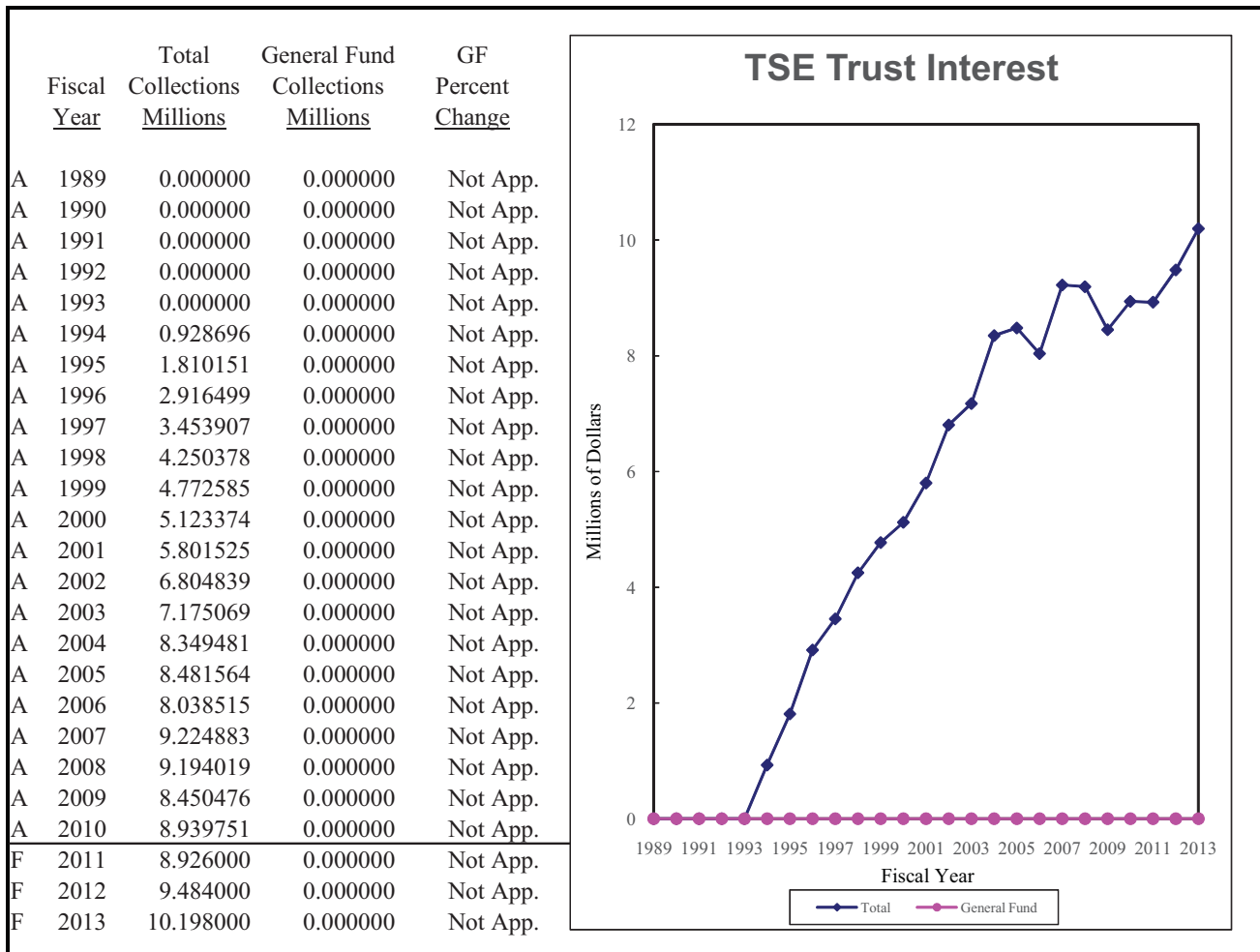

**Data Source(s):** Board of Investments, SABHRS, *Wall Street Journal*, IHS

**Contacts:** Department of Commerce and Department of Natural Resources and Conservation

---

# Legislative Fiscal Division

## Revenue Estimate Profile

### Treasury Cash Account Interest

---

**Revenue Description:** The Department of Commerce, Board of Investments is responsible for investing all state funds. Title 17, Chapter 6, MCA, provides guidelines under which the funds must be invested. Unless specifically stated by statute, all interest earned on these investments is deposited in the general fund. Treasury cash is invested in a mixture of short and medium-term investments. Consequently, the interest assumptions adopted by the legislature incorporate a blend of short and intermediate-term rates. When needed to address cash flow problems, the state typically issues tax and revenue anticipation notes (TRANS). The legislature would then adopt TRANS issuance assumptions, since this affects the average invested balance. No TRANS issues are anticipated in the 2011 or 2013 biennia.

**Statutory Reference:**

Tax Rate – NA

Distribution (MCA) – 17-6-202(2)

Date Due – interest deposits are mostly made monthly, with two in June and none in July

**Applicable Tax Rate(s):** N/A

**Distribution:** All investment earnings on the treasury cash account (TCA) are deposited into the general fund.

Distribution Chart:

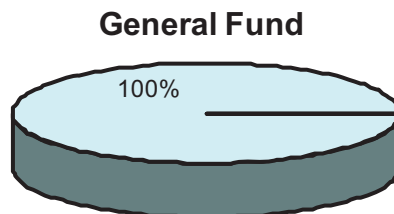

**Collection Frequency:** On-going

**% of Total General Fund Revenue:**

FY 2004 – 0.46%

FY 2007 – 1.85%

FY 2010 – 0.17%

FY 2005 – 0.66%

FY 2008 – 1.57%

FY 2006 – 1.09%

FY 2009 – 0.86%

**Revenue Estimate Methodology:**

Excess cash in the state treasury is deposited to the treasury cash account (TCA) and invested in short and medium-term investments. Earnings are dependent on the investable cash balance and interest rates. Investment earnings are deposited to the general fund.

Data

The Board of Investments provides monthly reports on the treasury cash account balance. The state accounting system (SABHRS) provides information on monthly investment earnings.